



Your **Safety**. Our **Priority**.

Product Catalogue



Welcome to Quality Safety International.

QSi is a New Zealand based, Australasian leader and innovator in industrial safety solutions. We manufacture, assemble and test our products on site so you can be assured of the highest quality. We are renowned for delivering innovative and customised solutions. We ask "What do you, the customer, want?"

Our story

We value our relationships throughout New Zealand and the world. By choosing QSi, you will not only have access to a specialist supply network that spans New Zealand, but will be served by a passionate team who all believe in using the power of our 'global' knowledge and local expertise to fuel the success of our customers.





Our Vision

QSi is planning for success in a changing world. This extends from our products, services and systems to ensuring our customers have access to cutting edge standards, compliant safety equipment, garments and hardware.

This is encompassed in our vision to “lead innovation in the design and manufacture of safety equipment solutions, being renowned for quality in everything we do. Safety is our priority”.

Our Process

There are five themes which underpin and demonstrate our approach; these are:

- We are recognised as leaders in delivery of safety products and services
- We constantly look for ways to innovate and improve
- We will work with you collaboratively and will be responsive to your needs
- We have a team of professionals who are passionate about safety
- We actively look for ways we can add value to you achieving your goals.

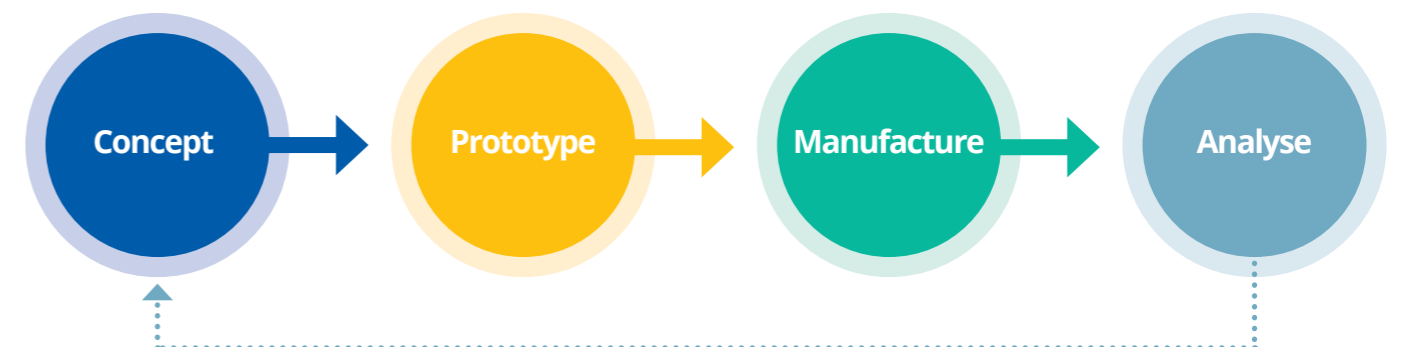

New Zealand's first IANZ accredited height safety laboratory

QSi are accredited by IANZ to test height safety gear to the AS/NZS 1891.1: 2007, AS/NZS 1891.3 and AS/NZS 5532 standards. This means every product we make has been tested to the most stringent standards.

Having our own testing facility on site gives us the unique opportunity to take our products to the limit multiple times throughout the development process instead of relying on fewer, more expensive tests in a foreign lab.

This allows us to identify and solve problems quickly, greatly reducing development costs, resulting in a better and more affordable product for our customers.

Our Philosophy

QSi is sales driven and does not operate on simply a "Just in Time" service standard. We overstock product for the benefit of our customers. QSi goes to market with the question: "What do you, the customer want?"

Quality Safety is managed on a basis of strong principles and integrity, and we value our staff and customers.



Contents

Please note. Every effort has been made to ensure this catalogue is accurate but QSi make no guarantee that it is free of errors. Product specifications and availability are subject to change without notice.

First Aid Kits

Workplace and business kits	
Lone worker / vehicle kits	14
Industrial / commercial kits	15
Office kits	16
Restaurant and catering kits	17
Retail outlet (shop) kits	18
Home and leisure kits	
Household kits	19
Vehicle and travel kits	20
Sport and recreation	21
Specialised miscellaneous kits	22
Farming and rural kits	
Vehicle kits	23
Farm shed kits	24
Forestry kits	24
Burn kits	25
Major incident kits	27

Survival Kits & Equipment

Survival kits	31
Survival equipment	33

First Aid & Medical Products

Containers and soft packs	40
Bandages and clips	42
Plaster range	44
Food industry first aid products	45
First aid tapes	47
Wound care products	49
Wipes and disposal products	50
Cotton wool range	52
Irrigation solutions	52
Eye care products	53
Capsules, tablets, sprays and creams	54
Antiseptic sprays & creams	55
Anti-inflammatory and sports creams	56
Hot and cold packs	57
Kinesiology tape	57
Gloves and masks	58
Plastic and metal hardware	59
Rescue and emergency products	59
Injury support products	60
Medical equipment	61
Burn products	62
First aid signs	63
Insect repellent	63
Documentation	63
Fire products	63
Thermometers	64
Sunscreen	65
First aid tips sheet	66

Paramedic Rescue Equipment

Stretchers	70
Basket stretchers and accessories	71
Spine board and other stretchers	72
Immobilising system and accessories	73
Head and neck immobilisers	74
Other rescue equipment	75
Reflective clothing and accessories	77

Spill Solutions

ANA-Fibre products	82
Synthetic oil products	85
Synthetic chemical products	87
Synthetic general purpose products	88
Absorbency rates charts	89
Spill block products	90
Oil spill kits	92
Chemical spill kits	94
General purpose spill kits	95
Spill control products	96

Height Safety

Company profile	100
Standards guide	101
Fall protection guide	106
What's in the box - safe use information	107
Harnesses	
Basic harnesses	109
Specialty harnesses	116
Premium harnesses	119
FR and electric arc harnesses	123
Harness accessories and branding	129
Pole straps & lanyards	
Pole straps	131
Triple locking carabiner lanyards	133
Webbing	135
Kernmantle	136
Elasticated webbing	137
Webbing lanyards	138
Kernmantle rope lanyards	140
Bucket lanyards	140
Elasticated webbing shock absorbing lanyards	143
Energy absorbing blocks	145
Heavy duty fixed-length lanyards	146
Heavy duty adjustable lanyards	147
Retractable lanyards	149
Cable blocks	152
Slings and connectors	153
Bags	
Gear and duffel bags	157
Backpacks and tote bags	159
Rope and lifting bags	162

Height safety kits	
Roofing kits	163
Anchor systems	167
Temporary vertical line systems	170
Rope	
Rope kits	172
Rope	173
Rope accessories	175
Rope grabs	176
Ascenders and descenders	178
Temporary line systems	
Telescopic pole systems	179
Horizontal lifeline	181
Confined space and rescue equipment	
Rescue kits	183
Rescue tripods	184
Rescue winches	185
Rescue equipment	186
Stretchers and accessories	188
Climbing helmets	189
Pulleys and swivels	193
Metal hardware	
Hooks	
Triple action and specialty hooks	195
Double action snap hooks	196
Scaffold hooks	196
Carabineers	
Steel	197
Stainless steel	198
Alloy	199
Quick links	199
Material handling tools	200
Permanent anchorage systems	202
Belt lanyards	209
Tool lanyards	209
Wrist straps	210
Belt loops	211
Tool belts	211
Tool bags	212
Restraint systems	213
PVC harnesses	217

Industrial Clothing

IronWear Overalls	222
IronWear Wet Weather 5 in 1	223
ICETEC Freezer Wear	224
Safety Clothing - Reflective Vests	225
Electric arc clothing	227
Fabric guide	229
Kermel clothing	231
Protal clothing	233
Banwear clothing	235
Spectron clothing	237

ArcDry cotton clothing	239
ArcStorm wet weather clothing	240
Sizing charts	242
Switching garments	243
Accessories	246

Industrial Coveralls

Introduction	250
Buyers guide	251
Q-TECH 500	255
Q-TECH 1000L	255
Q-TECH 2000	256
Q-TECH 3000T	257
Comparison charts	259

General Safety Equipment

Safety eyewear	264
Ear protection	266
Hard hats	267
Respiratory masks	269
CleanSpace™ masks	273
Lock out products	277
Road & transport safety	279
Miscellaneous safety products	282

Signage

How to order	286
Our capabilities	288
Danger signs	291
Mandatory signs	296
Prohibition signs	301
Warning signs - Warning above triangle	306
Warning signs - Block and text	310
Caution signs	313
Beware signs - Red and yellow	314
Beware signs - With camera (& other)	315
Notice signs	316
Please signs	319
Emergency signs	323
Fire equipment ID signs	326
Fire info signs	327
Dangerous goods signs	330
HAZCHEM and spill kit signs	323
Entry and exit signs	333
Toilet signs	335
Recreation signs	337
Parking and access signs	339
Miscellaneous signs	342
Freestanding signs	343
Custom white boards	344
Custom branding	345



first aid kits

Lone worker / vehicle kits	14
Industrial / commercial kits	15
Office kits	16
Restaurant and catering kits	17
Retail outlet (shop) kits	18
Home and leisure kits	19
Vehicle and travel kits	20
Sport and recreation kits	21
Specialised miscellaneous kits	22
Farming vehicle kits	23
Farm shed kits	24
Forestry kits	24
Burns kits	25
Major incident kits	27

Terms and conditions

- Kit contents and brands may vary from time to time but quality will never be compromised
- First aid guides are not a substitute for formal first aid training
- Businesses are required to comply with the Health and Safety Act and have a first aid kit that can sufficiently handle the possible first aid risks that may occur at their place of work
- Though we can provide assistance and advice, the customer is responsible for choosing a kit that best suits their first aid risks
- Refill packs are not necessarily a full replacement of original kit contents but are designed to replace commonly used items
- Components in our Help-It first aid kits have a life-span of at least 18 months from date of assembly

Why choose a QSi Help-It first aid kit?

Quality | Help-It hand pick the highest quality components for their kits and travel to visit manufacturers to ensure consistent quality.

Value | Help-It first aid kits are known for being some of the most comprehensive and well stocked kits on the market. Where other manufacturers give you just the bare minimum, Help-It aim to provide the most first aid bang for your buck.

Assurance | The manufacturer is a Medsafe registered company. Where necessary, Help-It first aid kits exceed WorkSafe's minimum requirements.

Diverse | Help-It first aid kits are designed with your varying situations in mind. Whether you are on your own or part of a group, at home, at work or on the road, Help-It have a first aid kit designed just for you.

Accessibility | Speed is of the essence when it comes to first aid. Help-It kits have multiple compartments to keep every item in its place so you can find things quickly and easily.

Convenience | Help-It also provides handy refill packs for most kits in the range, taking the guesswork out of keeping your kit up to date. If you have any ideas for a kit specific to a customer's industry, please contact us to put it together for you.



Lone worker 1



Features

Ideal for people working on their own, this compact one person kit is designed to provide limited but essential first aid coverage. Also available with a compact fire extinguisher and mounting frame.

Product Codes

FAK010NIS	Lone worker 1
FAK010NISE	Lone worker 1 + fire extinguisher
FAK010NISREF	Refill pack (first aid kit only)

Lone worker 2



Features

A step up from the lone worker 1 and designed with tradesmen in mind, this compact kit is perfect for electricians, plumbers, builders, gardeners and other lone workers.

Product Codes

FAK010	Lone worker 2
FAK010REF	Refill pack

First aid tips



Features

All of our first aid kits come with this handy emergency guide containing a step-by-step CPR guide and key first aid action tips for most emergency situations, including:

- Shock
- Concussion
- Fainting & unconsciousness
- Choking
- Poisoning
- Chest pain
- Bleeding & minor wounds
- Eye injuries
- Burns
- Stroke
- Electric shock
- Bee or wasp stings
- Broken bones
- Hypothermia

Product Code

FATIP	First aid tips
-------	----------------

Industrial / commercial 1-5 person



Features

This small industrial kit is designed for 1-5 people and comes in either a soft pack or wall mountable plastic box. It is well suited for mobile work crews, small engineering firms and automotive workshops.

Product Codes

FAK015	Industrial 1-5 person kit - soft pack
FAK015PB	Industrial 1-5 person kit - wall mountable clip-off box
FAK015REF	Refill pack

Industrial / commercial 1-12 person



Features

This medium sized kit is designed for 1-12 people and is perfect for small factories, large automotive workshops and mobile work crews. Soft pack or plastic wall mountable box.

Product Codes

FAK112	Industrial 1-12 person kit - soft pack
FAK112PB	Industrial 1-12 person kit - wall mountable clip-off box
FAK112REF	Refill pack

Industrial / commercial 1-25 person



Features

A large first aid kit suitable for various commercial and industrial settings such as medium sized factories and distribution centres. Soft pack, plastic wall mountable box, or metal wall mountable box.

Product Codes

FAK016	Industrial 1-25 person kit - soft pack
FAK016PB	Industrial 1-25 person kit - wall mountable clip-off box
FAK016MB	Industrial 1-25 person kit - wall mountable metal box
FAK016REF	Refill pack

Industrial / commercial 1-50 person



Features

This extra large kit comes in a sturdy wall mountable metal box. Suitable for industrial workplaces with up to 50 people.

Product Codes

FAK500MB	Industrial 1-50 person kit - wall mountable metal box
FAK500MBREF	Refill pack

Office 1-5 person



Features

Suitable for up to 5 people, this kit is ideally suited to small legal and financial firms and other small office environments. In soft pack form, it is compact enough to suit the company car fleet. Also available in a sturdy wall mountable plastic box.

Product Codes

FAKOF15	Office 1-5 person kit - soft pack
FAKOF15PB	Office 1-5 person kit - wall mountable clip-off box
FAKOF15REF	Refill pack

Office 1-12 person



Features

Designed for up to 12 people, this kit is ideally suited to medium sized office environments such as medical centres, accountancy firms and real estate agencies. Available in both soft pack and wall mountable plastic box.

Product Codes

FAKOF112	Office 1-12 person kit - soft pack
FAKOF112PB	Office 1-12 person kit - wall mountable clip-off box
FAKOF112REF	Refill pack

Office 1-25 person



Features

The biggest kit in the Help-It office range, it suits large offices such as call centres, government departments, large legal and financial firms. Available in both soft pack and wall mountable plastic box.

Product Codes

FAKOF125	Office 1-25 person kit - soft pack
FAKOF125PB	Office 1-25 person kit - wall mountable clip-off box
FAKOF125REF	Refill pack

Small catering kit



Features

Suitable for small food businesses such as fish'n'chip shops, delicatessens, butchers shops, bakeries and lunch bars. Available in both soft pack and wall mountable plastic box.

Product Codes

FAKFOOD1	Small Catering Kit - Soft Pack
FAKFOOD1PB	Small Catering Kit - Wall Mountable Clip-Off Box
FAKFOOD1REF	Refill pack

Medium catering kit



Features

Designed for medium sized food businesses such as small restaurants, cafeterias, and catering companies. Available in both soft pack and wall mountable plastic box.

Product Codes

FAKFOOD2	Medium Catering Kit - Soft Pack
FAKFOOD2PB	Medium Catering Kit - Wall Mountable Clip-Off Box
FAKFOOD2REF	Refill Pack

Large catering kit



Features

Available in a wall mountable steel box, this first aid kit will suit any large commercial kitchen including restaurants, hotels and food production factories.

Product Codes

FAKFOOD3	Large Catering Kit - Wall Mountable Metal Box
FAKFOOD3REF	Refill Pack

Medium retail outlet



Features

This kit is designed for retail stores with up to 5 staff and comes in either a soft pack or wall-mountable plastic box. Its compact size makes it well suited to small-medium shops where storage space is limited.

Product Codes

FAKMRO	Medium Retail Outlet Kit - Soft Pack
FAKMROPB	Medium Retail Outlet Kit - Wall Mountable Clip-Off Box
FAKMROREF	Refill pack

Large retail outlet



Features

This comprehensive kit suits large retail stores with up to 25 staff such as department stores, car yards and hardware stores. It comes in either a soft pack or wall-mountable plastic box.

Product Codes

FAKLRO	Large Retail Outlet Kit - Soft Pack
FAKLROPB	Large Retail Outlet Kit - Wall Mountable Clip-Off Box
FAKLROREF	Refill pack

Multi-purpose kits



Domestic multi-purpose kit features

The Domestic Multi-purpose Kit is perfect for covering all your bases. It's compact enough to be used as a vehicle or personal kit but comprehensive enough to serve as a small kit for up to 5 people.

Commercial multi-purpose kit features

The Commercial Multi-purpose kit contains the same comprehensive range of products found in the Domestic version plus saline ampoules to ensure the kit meets commercial use requirements.

Product Codes

FAKSP	Domestic Multipurpose First Aid Kit - 56 Piece
FAKSPREF	Refill Pack
FAKMP	Commercial Multipurpose First Aid Kit with 4x 15ml saline ampoules
FAKMPREF	Refill pack

Mum's essentials kit



Features

Just as the name suggests, this affordable first aid kit contains all the basics needed to cope with basic injuries around the house.

Product Codes

FAKME	Mum's Essentials Kit - Soft Pack
FAKMREF	Refill Pack

Mum's supreme kit



Features

For safety conscious mums (and dads), this medium sized soft pack kit has everything you need to take care of most first aid incidents.

Product Codes

FAKMS	Mum's Supreme Kit - Soft Pack
FAKMSREF	Refill Pack

Dad's shed kit



Features

The perfect antidote to most of Dad's DIY disasters, this wall-mountable shed kit has the gear every handyman needs.

Product Codes

FAKDS	Dad's Shed Kit - Wall Mountable Clip-Off Box
FAKDSREF	Refill Pack

Family car kit



Features

A basic compact first aid kit comprehensive enough to cope with most of life's little travelling mishaps.

Product Codes

FAKFC	Car Kit - Soft Pack
FAKFCREF	Refill pack

Glovebox kit



Features

This first aid kit is an ideal size for storage in your car glove box. Will suit most basic first aid requirements for the family car. It is belt mountable for ensuring you have first aid on hand while hiking or enjoying a family picnic.

Product Codes

FAKGB	Glovebox Kit - Soft Pack
FAKGBREF	Refill Pack

First aid essentials kits



Features

You won't believe how much essential first aid gear we've packed into these tiny cases! Perfect for backpackers and any other situation where space is at a premium. Comes in a robust canvas pouch with belt loops, or a small plastic case. This kit measures just 10.5 x 9 x 3.5cm.

Product Codes

FAK04B	First Aid Essentials Kit - Mini Plastic Box
FAK04BREF	Refill pack
FAK04A	First Aid Essentials Kit - Pouch
FAK04AREF	Refill Pack

Travel & outdoor kit



Features

Whether with the family, or on your own, this fully featured soft pack kit is perfect for camping and holidaying.

Product Codes

FAKTAO	Travel and Outdoor Kit - Soft Pack
FAKTAOREF	Refill Pack

Recreational boating kit



Features

Securely contained in a clear, watertight plastic box, this kit is specially designed to cope with most boating incidents.

Product Codes

FAKBOAT01	Recreational Boating Kit - Plastic Watertight Box
FAKBOATREF	Refill Pack

Small sports kit



Features

A compact first aid kit with the essential tools to take care of many typical sporting injuries.

Product Codes

FAKSNC	Small Sports Kit - Soft Pack
FAKSNCREF	Refill Pack

Large sports kit



Features

Big enough to provide comprehensive first aid coverage for a full squad, but compact enough to be easily carried to matches.

Product Codes

FAKLNC	Large Sports Kit - Soft Pack
FAKLNCREF	Refill Pack

Comprehensive sports event kit



Features

This kit is perfect for sporting event hosts and organisers to ensure you have the first aid gear to cover multiple injuries of different kinds. Comes in a premium first responder bag with multiple external and internal pockets so your most important equipment is close to hand.

Product Codes

FAKCNC	Comprehensive Sports Event First Aid Kit in First Responder Bag
FAKCNCREF	Refill Pack

Motorsport kit



Features

Great for offroad and rally enthusiasts, this light, portable first aid kit has contents to cater for typical motorsport injuries such as burns, cuts and bruises. Bag includes sturdy velcro straps, allowing easy attachment to roll cages or seats.

Product Codes

FAK013	Motorsport Kit - Soft Pack
FAK013REF	Refill pack

Equine first aid kit & cool pack



Equine first aid kit features

A basic first aid kit designed to provide essential coverage for the most common injuries to horses. Light, compact and easily carried on the trail in a backpack or saddle bag.

Equine cool pack features

A large set of instant ice-packs and gauze bandages with ice-pack pockets. Great to have on hand at the stables, or use it to replenish your Equine First Aid Kit.

Product Codes

FAKEQU1	Equine Kit - Soft Pack
FAKEQU1REF	Refill Pack
FAKEQU2	Equine Cool Pack

Eye wash kit & eye wash shelf



Eye wash kit features

This wall mountable kit contains essential first aid tools for dealing with eye injuries and contaminations.

Eye wash shelf features

A metal shelf with mirror, plus saline and eye wash bottle.

Product Codes

EYESTATION2	Eye Wash Kit - Plastic Wall Mountable
EYESTATION2REF	Refill pack
EYESTATION1	Eye Wash Shelf - Metal Wall Mountable

Pig hunting kit



Features

The essential first aid tools for dealing with injuries to dogs while in the bush. Comes in a sturdy belt-mountable pouch.

Product Codes

FAKPIG	Pig Hunting Kit - Soft Pack
FAKPIGREF	Refill Pack

Quad bike kit



Features

Ideal for farmers working on their own, this compact one-person kit has all the basic essentials to provide limited but essential first aid coverage when out on your quad.

Product Codes

FAKQB	Quad Bike Kit - Soft Pack
FAKQBREF	Refill Pack

Ute & tractor kit



Features

The next step up from the quad bike kit, this first aid kit is still compact enough to stow in your ute or tractor cab.

Product Codes

FAKUAT	Ute & Tractor Kit - Soft Pack
FAKUATREF	Refill Pack

Midi farm shed kit



Features

A fully featured shed kit in a plastic wall mountable box for small to medium sized farms.

Product Codes

FAK012B	Midi Farm Shed Kit - Wall Mountable Clip-Off Box
FAK012BREF	Refill Pack

Maxi farm shed kit



Features

The pinnacle of Help-It first aid kits for farmers, this comprehensive kit comes in a wall mountable metal box and is suitable for medium to large sized farms.

Product Codes

FAK012A	Maxi Farm Shed Kit - Wall Mountable Metal Box
FAK012AREF	Refill Pack

Up a tree kit



Features

A basic emergency kit designed to help forestry workers deal immediately with injuries sustained while working up a tree. The kit comes in a rugged, low-profile belt-mountable pouch.

Product Codes

FAK777	Up A Tree Kit - Premium - Soft Pack
FAK777REF	Refill pack
FAK555	Up A Tree Kit - Standard - Soft Pack
FAK555REF	Refill pack

Forestry crew kit



Features

A medium sized first aid kit for forestry crews. Available in soft pack or clear plastic box.

Product Codes

FAKCREW	Forestry Crew Kit - Soft Pack
FAKCREWPB	Forestry Crew Kit - Clear Plastic Wall Mountable Clip-Off Box
FAKCREWREF	Refill pack

Basic forestry small kit



Features

A basic general first aid kit for forestry workers. It comes in a rugged, low-profile belt-mountable pouch.

Product Codes

FAKBF	Basic Forestry Small Kit - Soft Pack
FAKBFREF	Refill pack

Comprehensive outdoor kit



Features

A comprehensive first aid kit for large forestry crews and other groups working in the outdoors, in isolated areas away from immediate medical attention.

Product Codes

FAKCO	Comprehensive Outdoor Kit - Soft Pack
FAKCOREF	Refill Pack

Personal burns kit



Features

A compact burns kit with the limited essentials required to help most burns injuries.

Product Codes

BK003	Personal Burns Kit - Soft Pack
BK003REF	Refill Pack

Commercial burns kit



Features

A fully featured burns kit for most commercial situations. Available in soft pack and green wall mountable plastic box.

Product Codes

BK001	Commercial Burns Kit - Soft Pack
BK001PB	Commercial Burns Kit - Wall Mountable Clip-Off Box
BK001REF	Refill Pack

Industrial burns kit



Features

A comprehensive burns kit for most industrial situations. Available in soft pack and metal wall mountable box.

Product Codes

BK002	Industrial Burns Kit - Soft Pack
BK002PB	Industrial Burns Kit - Wall Mountable Clip-Off Box
BK002MB	Industrial Burns Kit - Wall Mountable Metal Box
BK002REF	Refill pack

Burn gel pack



Features

A great supplement to any first aid kit when the risk of burn injuries is higher. Consists of one 10cm x 10cm Help-It burn gel dressing and three Help-It burn gel sachets.

Product Codes

BURNGELPACK	Burn Dressing Pack
-------------	--------------------

Major incident kit in backpack



Features

The Major Incident Kit is more than just a first aid kit. Within the large, easy-to-carry backpack you'll find a range of individual mini-kits, each designed to cater for a specific incident. Responding to a fire emergency? Grab the burns kit. Major trauma event? Grab the major injury kit. Supplied mini-kits include:

- eye injury
- burn injury
- minor injury
- major injury

The Major Incident Kit is designed for big events with large numbers of people spread across a wide area, where you can expect a range of different incidents to occur, some more severe than others:

- sporting events
- concerts
- festivals
- fielddays

Comes with contents list card and re-stock form.

Product Codes

FAK014	Major Incident Kit in Backpack
FAK014REF	Refill Pack





➤ help-it.
protect & heal

survival kits & equipment



Three person 72hr survival kits



Features

A larger and more comprehensive kit designed for up to three people, contains emergency rations, survival blankets, ponchos, first aid essentials and much more. Will last three people up to four days.

Product Codes

FAKSK01 Three Person 72hr Survival Kit

Ready to run survival kit



Features

The QSi Ready To Run Kit will give one person the essentials to survive for up to 72 hours, providing food, warmth and basic first aid equipment. Supplied in 24L backpack or lime yellow drawstring nylon bag.

Product Codes

FAKSK02 Ready to Run Backpack Kit

FAKSK03 Ready to Run Drawstring Bag

Children's survival kit



Features

Even children need to be prepared for emergency situations. This kit contains the basics of shelter and protection from the elements. Designed to give your child the security of knowing they have the equipment to deal with minor emergencies

Product Codes

FAKSK04 Children's Survival Kit

Vehicle glove box survival kit



Features

This compact vehicle survival kit is designed to fit into your car boot or glove box so that it is handy at all times when you are away from home. Disasters can happen anywhere and it is important to be prepared for emergencies even when travelling.

Product Codes

FAKSK05 Glove Box Survival Kit

1 - 12 person wheelie bin survival kit



Features

The largest of our survival range, this kit is designed for up to twelve people, contains emergency rations, survival blankets, ponchos, first aid essentials and much more. Will last twelve people up to four days.

Product Codes

FAKSK06 Wheelie Bin Survival Kit

QSi pandemic survival kit



Features

The QSi Pandemic Kit will give you all the basic equipment needed to survive an emergency where air, waterborne bacteria or disease is a problem. Hand sanitiser and water purification tablets, paracetamol, gloves and masks included.

Product Codes

FAKSK07 QSi Pandemic Kit

QSi hygienic cleanup kit



Features

A small, economical kit designed to allow you to clean up spills where a protective barrier between you and the contaminated substance is required. Ideal for vomit, bodily fluids such as blood, or decomposed foods. Contains gloves, masks, antiseptic wipes and more.

Product Codes

FAKSK08 QSi Hygienic Cleanup Kit

QSi one person survival kit



Features

A compact 1 person survival kit supplied in a bag. This kit contains food, first aid, shelter and light equipment. Small and portable, this kit is ideal for home or office use.

Product Codes

FAKSK09 QSi Single Person Survival Kit

Emergency food ration bar 3600cal



Features

Providing 3600 calories per bar, these rations are enough for one person to survive for up to four days. They are supplied in a waterproof resealable wrapper. Great for the bottom of a backpack or survival kit.

Product Codes

CDFB3600 Emergency Food Bar

Emergency foil survival blanket



Features

Made from polyester aluminium foil, designed to reflect body heat back to the user. Ideal as a water and wind-resistant shelter. These blankets make excellent groundsheets. Blankets measure 130cm x 210cm.

Product Codes

BLARECSS Emergency Foil Rescue Blanket

Emergency foil sleeping bag



Features

Made from the same aluminium foil as the survival blankets. These sleeping bags are a great form of protection from the elements. Water and wind resistant, excellent thermal retention, perfect for use in conjunction with survival blankets.

Product Codes

BLARECSSBAG Emergency Foil Sleeping Bag

High protection blanket



Features

Waterproof, latex free and x-ray transparent. Non-conductive for electrical current. A total bacterial barrier which is thermal retentive.

Product Codes

EMERGBLANKET Heavy Duty Emergency Blanket 120x150cm

Disposable poncho



Features

A lightweight strong disposable poncho. One size fits most, these raincoats are waterproof and wind resistant. A great addition to any survival kit.

Product Codes

PONCHOY Disposable Poncho - Yellow

Aqua tab water purification tablets



Features

Aquatabs water purification tablets make water safe for drinking, cleaning teeth, washing wounds and fruit and vegetables. 50 pack.

Product Codes

TABPURI50 Water Purification Tablets - 50s

Light sticks



Features

Great for emergency lighting, will glow for eight to twelve hours. Sold in sealed foil packet.

Product Codes

GLOWSTG Emergency Glow Stick - Green

Hand sanitiser



Features

A range of colours and fragrances. These bottles of hand sanitiser make a great addition to any survival kit.

Product Codes

HANSAN60 Hand Sanitiser - 60ml

HANSAN236 Hand Sanitiser - 236ml

Essentials portable first aid kit



Features

A compact one-person first aid kit supplied in a red plastic case. This kit contains the basic components for an emergency first aid kit. Small and portable, this kit is ideal for home or office use.

Product Codes

FAK04B First Aid Essentials Kit

Dynamo torch with radio



Features

- A must-have for any emergency kit, this torch is fully power independent.
- Hand-crank dynamo charges the built-in Lithium-Ion battery. No more hunting around for spare batteries!
- One minute of cranking provides up to ten minutes of torch light, or up to thirty minutes of radio time.
- Three bright white LEDs provide plenty of light.
- Scanning FM radio is easy to use and keeps you entertained and informed.
- Body material: ABS plastic
- Product size: 140mm x 60mm x 45mm
- Weight: Approx 160g

Product Codes

SURFLARAD003 Dynamo Torch with Radio

6mm multi purpose cord



Features

Multi-filament general purpose cord. Sold in 10m lengths. Soft and easy to handle or tie. This cord has a 200kg breaking strain.

Product Codes

SURMPC6 6mm Multi Purpose Cord

Disposable dust mask



Features

Industrial quality FFP2 disposable masks. AS/NZS 1716:2012 approved. Strong durable design, very comfortable. Available with or without filter, carbonated charcoal model available also.

Product Codes

HI8620 Help-It FFP2 Moulded Mask - Box of 20
 HI8622 Help-It FFP2V Moulded Mask with Valve - Box of 10
 HI8626 Help-It FFP2CV Carbon Valved Moulded Mask - Box of 10

High visibility vests - adult and child sizes



Features

Available in Orange or Hi Vis Yellow. These vests are available in a full range of sizes - both adult and children. Custom labelling available on request. Day vest (no reflective tape) also available.

Product Codes

VESHIVISY_ Hi Vis Reflective Vest - Yellow
 VESHIVISO_ Hi Vis Reflective Vest - Orange
 VESHIVISY-CHILD_ Children's Hi Vis Reflective Vest - Yellow
 VESHIVISO-CHILD Children's Hi Vis Reflective Vest - Orange

Hi Vis orange multi-function knife



Features

- Knife
- Corkscrew
- Bottle Opener
- Can Opener
- Compass
- Signal Mirror
- Hole Punch
- Phillips Screwdriver
- Blade Screwdriver
- Scissors

Product Codes

SURKNIORANGE Hi Vis Orange Multi Tool

Silver multi-function knife



Features

- Stainless Steel
- Knife
- Corkscrew
- Can Opener
- Small Saw
- Scale & Hook Removal Tool
- Scissors
- Hole Punch
- Nail File
- Phillips Screwdriver
- Blade Screwdriver

Product Codes

SURKNISILVER Silver Steel Multi Tool

Hi Vis survival whistle



Features

- Long Range Whistle
- Thermometer
- Compass
- Magnifying Glass
- Signal Mirror
- Small storage compartment
- Neck Lanyard

Product Codes

SURWHI6IN1 Hi Vis Survival Whistle

Hi Vis economy survival whistle



Features

Hi Vis orange colour

Product Codes

SURWHISTLE Hi Vis Survival Whistle - Economy



➤ help-it.
protect & heal

first aid & medical products

Why choose a QSi Help-it first aid & medical...

As per our Help-It philosophy; *"Protect and Heal"* – we take our role very seriously in the medical and first aid arena.

Importing and assembling pharmaceutical grade products is the key to our success.

We won't compromise on quality, and sell products that are fit for purpose and have been tried and tested in the market for years.

Don't compromise on your worker's or family's health and safety - ask for Help-It products.



Wall-mountable plastic boxes



Features

Green: 27 x 18.5 x 11.5cm. Clear: 24.5 x 18 x 9cm. Green box features clear plastic compartments to keep your first aid products organised, visible, and easy to access.

Product Codes

FABWMGR	Green First Aid Box - wall-mountable
FABWMCL	Clear First Aid Box - wall-mountable

Plastic containers



Features

Air tight and water tight click-shut containers in three sizes.

Product Codes

FABCL2L	2L Air-tight / Water-tight container
FABCL3L	3L Air-tight / Water-tight container
FABCL5L	5L Air-tight / Water-tight container

Metal box



Features

Large, robust, metal first aid cabinet. Compartments for easy storage options. 44 x 29 x 15cm

Product Codes

FACABWM	White Empty Metal Wall Mountable First Aid Box
FACABWMG	Green Empty Metal Wall Mountable First Aid Box

First aid small red plastic box



Features

Compact and stylish first aid box. Ideal for travellers and backpackers, when space is limited. 10.5 x 9cm

Product Codes

FABSMR	First Aid Small Red Plastic Box
--------	---------------------------------

Premium first aid bags



Features

With fold-out compartments.
 Small: 20 x 14 x 6cm. Large: 25 x 19 x 9.5cm
 First Aid Soft Packs

Product Codes

FABNH	Small Bag - no handles
FABH	Large Bag - with handles
FABDB	Double first aid bag - 2x FABHs sewn back to back

Responder first aid bag



Features

With fold-out compartments.

Product Codes

FABRES	Responder First Aid Bag
--------	-------------------------

Economy first aid bags



Features

Small: 20 x 11 x 5cm. Large: 24 x 6 x 7cm

Product Codes

FABECOSM	Small Economy First Aid Bag
FABECOLG	Large Economy First Aid Bag

Budget clear plastic first aid bags



Product Codes

FABCLESM	Small Clear Plastic First Aid Bag
FABCLELG	Large Clear Plastic First Aid Bag

Crepe bandages



Features

Stretchy cotton bandage, offering support to strains, sprains, and providing compression to alleviate swelling.

Product Codes

BANCRE5	5cm x 4.5m* Crepe Bandage
BANCRE7.5	7.5cm x 4.5m* Crepe Bandage
BANCRE10	10cm x 4.5m* Crepe Bandage
BANCRE15	15cm x 4.5m* Crepe Bandage

* length when stretched

Bandage clips



Features

Use in place of safety pins for quick and easy securing of bandages. Comes in packs of 10 or 50.

Product Codes

BANCLIP10	Pack of 10 Bandage Clips
BANCLIP50	Pack of 50 Bandage Clips

Trauma bandage



Features

Specially designed first aid device that is used to stop bleeding from hemorrhagic wounds caused by traumatic injuries. The bandage consolidates numerous treatment pieces into a single, easy to use unit. Available in 3 sizes.

Product Codes

BANTRAUMA	The Israeli Military (Trauma) Bandage 4 inch
BANTRAUMA6	The Israeli Military (Trauma) Bandage 6 inch
BANTRAUMA8	The Israeli Military (Trauma) Bandage 8 inch

Triangle bandages



Features

The Help-It triangular bandage is a square piece of cloth that can be folded into triangle and used as a sling, or can be rolled up and folded to be used as a bandage. Comes with two safety pins.

Product Codes

BANTRIDIS2PL	Large size - 110 x 110cm
BANTRIDIS2P	Regular size - 96 x 96cm

Cohesive bandages



Features

Easy tear - no scissors needed. Sticks to itself - no glue, pins or knotting required! When ordering please indicate which colour you would like: Black=**BI**; Blue=**B**; Red=**R**; Beige=**Be**; Yellow=**Y**; White=**W**

Product Codes

BANCOH2.5_	2.5cm x 4.5m* Cohesive Bandage
BANCOH5_	5cm x 4.5m* Cohesive Bandage
BANCOH7.5_	7.5cm x 4.5m* Cohesive Bandage
BANCOH10_	10cm x 4.5m* Cohesive Bandage

* length when stretched

Conforming bandage



Features

This stretchy bandage is ideal for joints as it contours itself to the body without creasing.

Product Codes

BANCON2.5	2.5cm x 4.5m* Conforming Bandage
BANCON5	5cm x 4.5m* Conforming Bandage
BANCON7.5	7.5cm x 4.5m* Conforming Bandage
BANCON10	10cm x 4.5m* Conforming Bandage

* length when stretched

Elastic adhesive bandage



Features

Ideal for relieving sprains, strains, and supporting joints.

Product Codes

BANADH5	5cm x 4.5m* Elastic Adhesive Bandage
BANADH7.5	7.5cm x 4.5m* Elastic Adhesive Bandage
BANADH10	10cm x 4.5m* Elastic Adhesive Bandage

* length when stretched

Fabric plasters - boxed



Features

Help-It fabric plasters are flexible, durable, breathable, wash-resistant and feature a non-stick island dressing.

Product Codes

PLAFAB100	72mm x 19mm, Box of 100
PLAFAB50	72mm x 19mm, Box of 50
PLAFAB100W	76mm x 25mm (Extra Wide), Box of 100

Fabric plasters - bagged



Product Codes

PLAFAB20BAG	72mm x 19mm, Bag of 20
PLAFAB50BAG	72mm x 19mm, Bag of 50

Dressing strips

Product Codes

DRES1MFABBAG	7.2cm x 1m Fabric Dressing Strip in bag
DRES1MFAB5PK	1m Fabric Dressing Strips 5-pack in bag
DRES10X6FAB	10cm x 6cm Fabric Dressing Strip
DRES10X6NW	10cm x 6cm Non-Woven Dressing Strip

Plastic plasters



Features

At last, plastic plasters that actually stick! Help-It premium clear waterproof plasters and standard water resistant skin-tone plasters are flexible and breathable, and feature island dressings.

Product Codes

PLAPEF50	Help-It Classic Plastic Skin-tone Plasters - Box of 50
PLAPEF1000	Help-It Flesh Coloured Plastic Plasters - Box of 1000
PLAPE100	Clear Waterproof Plasters - Extra Wide, 76mm x 25mm, Box of 100

Fabric plaster shapes - assorted packs



Product Codes

PLAFAB20ASS	Assortment - Box of 20 (3 knuckle, 3 fingertip, 14 regular plasters)
PLAFABFE50	Finger Extension Plasters, Bag of 50
PLAFABFE100	Finger Extension Plasters, Bag of 100

Finger tip & knuckle plasters

Product Codes

PLAFABFT50	Finger Tip, Box of 50
PLAFABKN50	Knuckle, Box of 50

Blue metal detectable plasters



Features

We have the broadest range of food industry first aid products. Help-It blue metal detectable plasters have market-leading adhesive qualities and conform excellently to your skin, giving you improved confidence.

Product Codes

BLUPLA100	72mm x 25mm Plasters, Box of 100
-----------	----------------------------------

Blue metal detectable plaster shapes

Product Codes

BLUPLAFE50	160mm x 20mm Finger Extension Plasters, Pack of 50
------------	--

BLUPLAFT100	Box of 100 Fingertip Plasters
-------------	-------------------------------

BLUPLAKN100	Box of 100 Knuckle Plasters
-------------	-----------------------------



Blue metal detectable plaster assortments

Product Codes

BLUPLAMIX1	Blue Plaster Assortment, Box of 100: Mix 1 (80 standard, 10 fingertip, 10 knuckle)
------------	--

BLUPLAMIX2	Blue Plaster Assortment, Box of 100: Mix 2 (60 standard, 20 fingertip, 20 knuckle)
------------	--

BLUPLAMIX3	Blue Plaster Assortment, Box of 100: Mix 3 (90 standard, 5 fingertip, 5 knuckle)
------------	--

BLUPLAMIX4	Blue Plaster Assortment, Box of 100: Mix 4 (50 fingertip, 50 knuckle)
------------	---

BLUPLAASS40	Shapes Assortment, Bag of 40 (20 Fingertip, 20 Knuckle)
-------------	---

Blue metal detectable dressing strips



Product Codes

BLUDRESTR1M	1m x 7.5cm Detectable Dressing Strip
-------------	--------------------------------------

Blue visually detectable tape



Product Codes

BLUSTETAPE	5m x 25mm Blue Stero Tape on Spool
------------	------------------------------------

BLUPVCTAPE	20m x 18mm Blue PVC Insulation Tape
------------	-------------------------------------

Blue visually detectable cohesive bandage



Product Codes

BANCOH2.5B	Blue 2.5cm x 4.5m Cohesive Bandage
------------	------------------------------------

BANCOH5B	Blue 5cm x 4.5m Cohesive Bandage
----------	----------------------------------

BANCOH7.5B	Blue 7.5cm x 4.5m Cohesive Bandage
------------	------------------------------------

BANCOH10B	Blue 10cm x 4.5m Cohesive Bandage
-----------	-----------------------------------

Blue metal detectable corded ear plugs



Features

QTECH blue metal detectable corded ear plugs. Soft and easy to use. Comes in individually packaged plastic bags.

- Disposable metal detectable PU foam
- Class 5 SLC80 26.2 dB
- Hearing protection for noise levels up to 110 dB(A)
- Contains 100 corded pairs
- Individually packaged
- Lightweight and comfortable

Product Codes

EARPLUGBLUBOX	Blue Metal Detectable Disposable Ear Plugs With Cord
---------------	--

Blue visually detectable hair net



Product Codes

BLUHAIRNET	Blue Visually Detectable Hair Net - 53cm
------------	--

Blue visually detectable finger cot



Product Codes

SPLCOTBL	Blue Visually Detectable Finger Cot
----------	-------------------------------------

White paper tape on dispenser



Product Codes

TAPPAPERDIS25	25mm x 9.1m Paper Tape Dispenser
TAPPAPERDIS12.5	12.5mm x 9.1m Paper Tape Dispenser

White translucent paper tape



Product Codes

TAPPAPER12.5	12.5mm x 9.1m Paper Tape Roll - White
TAPPAPER25	25mm x 9.1m Paper Tape Roll - White

Skin colour translucent paper tape



Features

Blends in with most natural skin tones. Two sizes available.

Product Codes

TAPFLE12.5	12.5mm x 9.1m Paper Tape Roll - Skin
TAPFLE25	25mm x 9.1m Paper Tape Roll - Skin

Fabric roll on spool - skin colour



Product Codes

TAPFAB12.5SP	12.5mm x 5mm fabric roll on spool
TAPFAB25SP	25mm x 5m fabric roll on spool

Sports rigid strapping tape



Product Codes

TASPORTS25	25mm x 13.7m single
TASPORTS25P	25mm x 13.7m single, wrapped
TASPORTS25PK5	25mm x 13.7m 5-pack
TASPORTS38	38mm x 13.7m single
TASPORTS38P	38mm x 13.7m single, wrapped
TASPORTS38PK5	38mm x 13.7m 5-pack
TASPORTSMIX	Assorted Pack: 2x 38mm, 1x 25mm

Clear easy tear tape



Features

Perforated design makes tearing in both directions easy. Super stick adhesive.

Product Codes

TAPCLEAR12.5	12.5mm x 9.1m Clear Tape Roll
TAPCLEAR25	25mm x 9.1m Clear Tape Roll

Gauze swabs



Features

Cotton non-woven swabs. 7.5cm x 7.5cm. Sterile.

Product Codes

GS001PK5NW	Non woven Gauze Swab 2's, pack of 5
GS001PK10NW	Non woven Gauze Swab 2's, pack of 10
GS001NWBOX	Gauze Swabs 2's Sterile Non Woven - 7.5 x 7.5cm (Box of 50)

Wound dressings



Product Codes

DRESLG18X18	18cm x 18cm pad on sterile bandage
DRESMED12X12	12cm x 12cm pad on sterile bandage
DRESWD013	No.13 BPC Wound Dressing 7.5x10cm
DRESWD014	No.14 BPC Wound Dressing 10x15cm
DRESWD015	No.15 BPC Wound Dressing 15x20cm

Gauze squares



Features

Packs of 100

Product Codes

GSNS05	5cm x 5cm Non-Sterile 8-Ply
GSNS075	7.5cm x 7.5cm Non-Sterile 8-Ply
GSNS10	10cm x 10cm Non-Sterile 8-Ply
GSNS10V	10cm x 10cm Non-Sterile Vet 12-Ply

Non adherent dressings



Product Codes

DRESNADSM	5cm x 7.5cm Dressing
DRESNAD5PKSM	5cm x 7.5cm Dressing, pack of 5
DRESNAD10PKSM	5cm x 7.5cm Dressing, pack of 10
DRESNADLG	7.5cm x 10cm Dressing
DRESNAD5PKLG	7.5cm x 10cm Dressing, pack of 5
DRESNAD10PKLG	7.5cm x 10cm Dressing, pack of 10

Combine dressings



Product Codes

DRESCOM10X9	10cm x 9cm Dressing
DRESCOM5PK	10cm x 9cm Dressing, pack of 5
DRESCOM20X20	20cm x 20cm Dressing
DRESCOM3PK	20cm x 20cm Dressing, pack of 3
DRESCOM20X10	20cm x 10cm Dressing
DRESCOM20X30	20cm x 30cm Dressing

Wound closure strips



Product Codes

SCS001	6mm x 75mm Pack of 3
SCS002	3mm x 75mm Pack of 5
SCS003	6mm x 38mm Pack of 6

Adhesive island dressing (non-woven)



Product Codes

DRESISLA7.5X5B	7.5cm x 5cm Dressings, box of 50
DRESISLA8X10B	8cm x 10cm Dressings, box of 50
DRESISLA10X15B	10cm x 15cm Dressings, box of 20

Can also be purchased as a single item.

Transparent waterproof dressing



Product Codes

DRESCLE4X5B	Transparent Waterproof Dressing 4x5cm - Box of 50
DRESCLE6X7B	Transparent Waterproof Dressing 6x7cm - Box of 50
DRESCLE10X12B	Transparent Waterproof Dressing 10x12cm - Box of 25

Can also be purchased as a single item.

Alcohol prep pads



Product Codes

WIPEALCOSIN	Alcohol Wipe - Single
WIPEALCO10PK	Alcohol Wipes - Pack of 10
WIPEALCO200	Alcohol Wipes - Box of 200

Povidone-iodine prep pad



Product Codes

WIPEPOVSIN	Povidone-Iodine Prep Pad - Single
WIPEPOV10PK	Povidone-Iodine Prep Pad - Pack of 10
WIPEPOV100	Povidone-Iodine Prep Pad - Box of 100

Antiseptic wipes



Features

Fold out to a large (195 x 105mm) antiseptic towelette. Beware of other brands whose wipes are small and impractical.

Product Codes

WIPEANTSING	Antiseptic Wipe - Single
WIPEANT10PK	Antiseptic Wipes - 10 Pack
WIPEANT50	Antiseptic Wipes - Box of 50

Clinical wipes



Features

QSI's medical grade, antibacterial surface disinfecting wipes have been specifically created to clean and disinfect most surfaces by eliminating 99% of bacteria. Clinical wipes render bloodborne pathogens inert.

Product Codes

WIPEMEDI02	Clinical Wipes medical grade moist towelettes - Tub of 160
------------	--

Disposal bag



Product Codes

BAGCLEUP02	Help-It Clean Up/Contaminant Bag 22x32cm
------------	--

Cotton wool range



Product Codes

COTPAD80S	Round Cosmetic Pads - Pack of 80
-----------	----------------------------------

Cotton tip applicators

Product Codes

COTTIP100	Cotton Tip Applicators - Pack of 100
-----------	--------------------------------------

Cotton wool balls

Product Codes

COTWB100	Cotton wool balls - Pack of 100
----------	---------------------------------

Cotton wool roll

Product Codes

COTWR50G	Help-It Cotton Wool Roll 50g
COTWR100G	Help-It Cotton Wool Roll 100g
COTWR400G	Help-It Cotton Wool Roll 400g

Pleated cotton

Product Codes

COTWPLE100	Pleated cotton wool - 100g
------------	----------------------------

Saline solution



Product Codes

SAL15AMP	15ml Saline Ampoule
SAL30AMP	30ml Saline Ampoule
EYEWASBOT250	Help-It Eye Wash Bottle Clear Empty 250ml
EYEWASBOT500	Help-It Eye Wash Bottle Clear Empty 500ml

Chlorhexidine



Product Codes

FLUCLOR30	Chlorhexidine Ampoules, 30ml, Box of 30
-----------	---

Eye drops



Product Codes

EYEDROP30 Refresh Eye Drops, 0.4ml Ampules, Box of 30

Optrex eye wash



Product Codes

FLUOPT110 Optrex Eye Wash with Eye Bath - 110ml

FLUOPT300 Optrex Eye Wash with Eye Bath - 300ml

Eye wash



Product Codes

SAL500BOT Help-it Saline 500ml Bottle With Eye Bath Attached

Eye wash kits



Product Codes

EYEBOT500SAL Eye Wash Bottle 250ml with Saline 500ml

EYEBOT500SALLG Eye Wash Bottle 500ml with Saline 500ml

Eye wash stations



Product Codes

EYESTATION1 Wall Mountable Shelf with Saline and Bottle

EYESTATION2 Eye Wash Kit in Plastic Wall Mountable Box

Paracetamol



Product Codes

PARCAP500MG Paracetamol Capsules 500mg - Box of 20

PARTAB500MG Paracetamol Tablets 500mg - Box of 20



Ibuprofen



Product Codes

TABIBUP200MLG Ibuprofen Tablets - Box of 20

Anti bacterial tablets



Product Codes

TABMILTONPK30 Milton Tablets - Box of 30

Water purification tablets



Product Codes

TABPURI10PK Aquatabs Water Purification Tablets - 10's

TABPURI50 Water Purification Tablets - Box of 50

Betadine antiseptic products



Product Codes

CREBET25	Betadine Antiseptic Ointment - 25g
BETLIQ100	Betadine Liquid - 100ml

Medipulv antiseptic powder



Product Codes

POWMEDPUL	Medipulv Antiseptic Powder - 12.5g
-----------	------------------------------------

HealthE antiseptic cream & liquid



Features

With Tea Tree Oil. Cleanses and helps protect against infection from cuts, abrasions and insect bites. Contains Chlorhexidine Digluconate Cetrimide.

Product Codes

CREHEAANT	HealthE Antiseptic Cream - 30g tube
FLUHEAANT	HealthE Antiseptic Liquid - 100ml spray bottle

Econo-range hand sanitiser



Product Codes

HANSAN60	Hand Sanitiser - 60ml
HANSAN237	Hand Sanitiser - 237ml

Help-it hand sanitiser



Features

MAF approved.

Product Codes

HANSAN500	Help-It Hand Sanitiser - 500ml
HANSAN5LTR	Help-It Hand Sanitiser - 5L

Arnica cream



Features

Assists the body's natural response to shock, injury, fatigue, bruising, and aids muscle recovery after strenuous exercise.

Product Codes

CREARN90	Naturo Pharm Arnica Cream - 90g tube
CREARN100	Martin & Pleasance Arnica Cream - 100g jar

Anti-flamme cream



Features

Herbal cream for bumps, bruises, aches and pains.

Product Codes

CREANF90	Anti-Flamme Cream - 90g tub
CREANF100	Anti-Flamme Cream - 100g tube
CREANF450	Anti-Flamme Cream - 450g tub

Deep heat



Product Codes

CREDEHEAT	Deep Heat - 100g
-----------	------------------

Warm-up cream



Features

Used to warm up muscles prior to sport or massage.

Product Codes

CREWUP2KG	Warm Up Cream - 2kg
-----------	---------------------

Cold spray



Product Codes

SPRCOLD	Medi-First Cold Spray 113g
---------	----------------------------

Reusable hot & cold packs



Features

Reusable hot & cold medium sized pack. Heat in the microwave or cool in the freezer. Comes with quality soft terry-towel.

Product Codes

HOTCOLPRE Premium Reusable hot/cold pack

Instant ice packs



Features

Instant Ice Packs - Strike, Shake and Use.
 Small: Dimensions: 140mm x 110mm, Weight (approx.): 12g
 Large: Dimensions: 210 x 140mm, Weight (approx.): 26g

Product Codes

ICEPACDISL Large Instant Ice Pack - Disposable

ICEPACDISS Small Instant Ice Pack - Disposable

Kinesiology sports tape



Features

Kinesiology Tape is used to help support muscles ligaments and tendons that have been injured or are prone to injury, including:

- Back pain
- Hamstring pain
- Knee pain
- Neck pain
- Joint support
- Shoulder pain
- Wrist pain
- Ankle sprains
- Achilles tendon
- Elbow pain
- Shin Splints
- Carpal tunnel

When ordering please indicate which colour you would like:
 Black=**Bl**; Blue=**B**; Beige=**Be**; Pink=**P**

Product Codes

KTAPE5_ Kinesiology Tape 5cm

KTAPE2.5_ Kinesiology Tape 2.5cm

Sterile latex surgical gloves



Features

Sterile Powder Free Latex Glove. One size fits most.

Product Codes

GLOSTERILE Sterile Latex Gloves - powder free

Bastion standard latex gloves



Features

Sizes S, M, L, XL. Dispenser box of 100.
 Note: when ordering gloves, please add the size you require to the end of the product code.

Product Codes

GLOLATPBAS_ Bastion Latex Gloves - powdered

GLOLATNPBAS_ Bastion Latex Gloves - powder free

QTECH black nitrile gloves



Features

Medical grade, textured grip gloves that work on touch screens.
 Sizes S, M, L, XL, XXL. Dispenser box of 100 (90 for XXL).

Product Codes

GLONITBLAS100 Black Nitrile Gloves (Box of 100) Size S

GLONITBLAM100S Black Nitrile Gloves (Box of 100) Size M

GLONITBLAL100S Black Nitrile Gloves (Box of 100) Size L

GLONITBLAXL100S Black Nitrile Gloves (Box of 100) Size XL

GLONITBLA2XL Black Nitrile Gloves (Box of 90) Size 2XL

Help-It doctors surgical procedure masks



Features

3 Ply, 99% efficient.

Product Codes

MASKNZ3PLYTIES Mask with Ties - Box of 50

MASKIMP3PLYEL Mask with Ear Loops - Box of 50

Tweezers



Product Codes

TWESHARPL	Sharp Pointed Tweezers - 13cm
TWE1STAIID	First Aid Quality Tweezers
TWEPLASTIC	Disposable Plastic Tweezers

Safety pins



Product Codes

SAFPINS10	Pack of 10 Safety Pins
SAFPINS1000	Pack of 1000 Safety Pins

Splinter probes



Product Codes

SPLPROB5	Blister-pack of 5 Splinter Probes
SPLPROB100	Box of 100 Splinter Probes

High efficiency protective masks



Product Codes

SCISHEARMIL	Military shears
SCISHEARL	Large Rescue Shears - 19cm
SCIMEDSHEAR	Blue-handle Nurse's Mini Shears - 15cm
SCISHARPBLUNT	Sharp/Blunt/Nursing Tip Scissors - 13cm
SCIWIRE	Wire Scissors - 10cm

Help-it rescue blankets



Product Codes

BLARECSS	Silver Rescue Emergency Disposable Blanket
BLARECSSBAG	91cm x 213cm Silver Rescue Sleeping Bag
EMERGBLANKET	Heavy Duty Emergency Blanket 120x150cm

Emergency glow stick



Features

8-12 hour light duration

Product Codes

GLOWSTG	Emergency Glow Stick - Green
---------	------------------------------

Adjustable moldable foam splints



Features

Fold to create gutter, place limb inside and bandage in place. Can be easily cut to size. These products are radiolucent.

Product Codes

SPLADJFIN	Moldable Finger Splint
SPLADJMOL	Large Moldable Splint

Tubular bandage applicator



Product Codes

SPLPLAFIN	Tubular Bandage Applicator
-----------	----------------------------

Adjustable neck collar



Product Codes

COLNECADJB	Adjustable Neck Collar - Adult
COLNECADJP	Adjustable Neck Collar - Pediatric

Sling



Features

Comfortable, padded collar and cuff sling, ready to use.

Product Codes

COL&CUF	Sling - Collar and Cuff
---------	-------------------------

Tongue depressors



Product Codes

TONDEP	Tongue Depressors - Box of 100
--------	--------------------------------

Hand suction unit



Product Codes

PARA01	Hand Suction Unit
--------	-------------------

Kidney dish



Product Codes

DISHKID	Kidney Dish - 200ml
---------	---------------------

Sharps container



Features

Other sizes available on request.

Product Codes

SHACON1.4L	Sharps Container - 1.4L capacity
SHACON5L	Sharps Container - 5L capacity
SHACON10L	Sharps Container - 10L capacity

Burn gel pack



Features

A great supplement to any first aid kit when the risk of burn injuries is higher. Consists of one 10cm x 10cm Help-It burn gel dressing and three Help-It burn gel sachets.

Product Codes

BURNGELPACK	Burn Dressing Pack
-------------	--------------------

Burn gel dressings



Product Codes

BURNDRES5X15	Help-It Burn Dressing 5x15cm
BURNDRES10X10	Help-It Burn Dressing 10x10cm
BURNDRES20X45	Help-It Burn Dressing 20x45cm
BURNDRES30X40	Help-It Burn Dressing 30x40cm Face Mask

Burn gel



Product Codes

BURNGELSACHET	Help-It Burn Gel Sachet 3.5g - Individual or box of 250
BURNGELSACBOX	Help-It Burn Gel Sachet 3.5g - Box of 6
BURNGEL59	Help-It Burn Dressing 59ml Bottle
BURNGEL120	Help-It Burn Gel Bottle 120ml Spray



First aid signs



Product Codes

QSI3446	Emergency Shower PVC Sign 340mm x 240mm
QSI3560	Emergency Eye Wash PVC Sign 340mm x 240mm
QSI3683	Blue First Aid Cross PVC Sign 180mm x 180mm
QSI3412	First Aid Cross PVC Sign 340mm x 240mm
QSI3693	First Aid Cross Sticker 120mm x 140mm
QSI3748	Wash Your Hands PVC Sign 340mm x 240mm

Stingoes stop itch



Product Codes

FLUSTING25	Stingose Stop Itch Spray - 25ml
CRESTING25	Stingose Stop Itch Gel - 25g

Insect repellent



Product Codes

FLUAERO50ML	Aerogard Roll-On Insect Repellent - 50ml
FLUODCAN	Aerogard Odourless - Aerosol Can 150g
FLUODSPR	Aerogard Odourless - Pump Spray 135ml
FLUTROCAN	Aerogard Tropical - Aerosol Can 150g
FLUTROSPR	Aerogard Tropical - Pump Spray 135ml

Accident register book



Product Codes

FAREGL	Accident Register Book - Large A4
--------	-----------------------------------

Fire extenguisher



Features

Other sizes available on request. See pg. 76.

Product Codes

FIREXTV01	Fire Extinguisher - 1kg
-----------	-------------------------

Flat thermometers



Product Codes

THEFLAT	Flat Thermometer
---------	------------------

Digital thermometer



Features

Batteries included.

Product Codes

THEDIG	Digital Thermometer
THEDIGCOV200S	Covers - pack of 200
THEDIGCOV100S	Covers - pack of 100

Infrared ear thermometer



Features

Simple to use, ideal for the family, easy to clean. Batteries included.

Product Codes

THEDGEAR	Infrared Ear Thermometer
----------	--------------------------

Infrared ear thermometer



Features

Our new Infrared Ear Thermometer comes with 20 disposable tips, no cleaning required. This ensures that ear infections are not spread and wax does not build up and affect the operation of the device.

Product Codes

THEDGEAR-A	Infrared Ear Thermometer ET-100A with Disposable Probe
PROBCOV	Disposable tips, pack of 20.

Sunscreen SPF 30+



Product Codes

SUN002	Sunscreen 1L (SPF 30+)
SUN003	Sunscreen 500ml (SPF 30+)
SUN008	Sunscreen 75ml Tottle Bottle with Carabiner (SPF50+)

Sunscreen SPF 50+



Product Codes

SUN005	Sunscreen 1L (SPF 50)
SUN006	Sunscreen 500ml (SPF 50)
LIPBALMSPF50	Lip Balm Moisturising 12gm (SPF 50)

Help-It Kids sunscreen SPF 50+



Product Codes

SUN009B	Lip Balm SPF50+ 5gr BLUE
SUN009P	Lip Balm SPF50+ 5gr PINK
SUN010	KIDS SPF50+ Sunscreen 75ml Roll On
SUN011	KIDS SPF50+ Sunscreen 75ml Tottle Bottle with Carabiner
SUN012	KIDS SPF50+ Sunscreen 1L

First aid tips sheet



Features

When you're confronted with a medical emergency, you need to be able to respond quickly and accurately. We designed our first aid tips booklet with this in mind.

It has the basic info you need for most situations in a concise and easy-to-read format. It also includes a step-by-step CPR guide, with specific information when treating children and infants.

Our research indicated that information is slower to find in a booklet format. Instead, we designed ours to fold out into a single, A4 sized, double-sided page so you can see at a glance the info you need. It folds up small enough to fit in your wallet or even the smallest of first aid kits.

Product Codes

FATIP	First Aid Tips
-------	----------------





paramedic &
rescue equipment

We've got your back.

In an emergency, your focus is on the patient, one hundred percent. There's no time to think about your gear, no time to wonder if it's going to work as it should; when lives are at risk, your gear just has to work - period!

At QSi, we worry about the details for you. We source and manufacture high quality, affordable paramedic and rescue equipment so our customers can rest assured their gear will do its job, no questions asked.



Scoop stretcher



Features

Adjustable, lightweight aluminium stretcher designed for easy transfer of patient in emergency situations. Comes complete with patient restraint straps.

Folded size: 167cm x 42cm x 7cm

Expanded size: 214cm x 42cm x 7cm

Weight: 8kg | Max Load: 159kg

Product Codes

PARA26 Scoop Stretcher

Flat folding stretchers



Features

Compact, alloy-framed stretcher with wheels at one end to aid movement. Wheels and feet can be folded in and locked in place for storage. Comes complete with patient restraint straps.

Folded size: 93cm x 52cm x 23cm

Expanded size: 185cm x 52cm x 23cm

Weight: 5kg | Max Load: 159kg

Product Codes

PARA26A Flat Folding Stretcher - Model A

Double folding stretcher



Features

Lightweight alloy-framed stretcher that folds to half its length and one third its width. Comes with sturdy carry bag.

Folded size: 110cm x 18cm x 11cm

Expanded size: 221cm x 53cm x 15cm

Weight: 5kg | Max Load: 159kg

Product Codes

PARA23 Double Folding Stretcher

Quad folding stretcher



Features

Super-compact stretcher that folds down to only a quarter of its full size. Comes with sturdy carry bag.

Folded size: 56cm x 22cm x 20cm

Unfolded size: 215cm x 55cm x 14cm

Weight: 10kg | Max Load: 159kg

Product Codes

PARA23A Quad Folding Stretcher

Basket stretcher

Features

Basket stretchers provide a more secure solution; their high sides and ends help keep your patient stable, especially when being transported in steep terrain, and they have special attachment points for winch, belay or helicopter rescues.

Size: 219cm x 64cm x 18cm

Weight: 16kg

Max Load: 159kg

Product Codes

PARA37	Basket Stretcher
--------	------------------

Break apart basket stretcher

Features

All the same great features of our standard basket stretcher but in a compact, break apart design for easy transport and storage.

Assembled size: 219cm x 64cm x 18cm

Disassembled size: 130cm x 67cm x 29cm

Weight: 16kg

Max Load: 159kg

Product Codes

PARA37A	Break apart basket stretcher
---------	------------------------------

- Sturdy attachment points for ropes and carabiners
- Multiple hand grips around edge of the stretcher
- Four safety belts for securing patient
- Adjustable foot plate

Lifting bridle - adjustable legs

Features

Four-legged, adjustable lifting bridle designed to attach to stretchers and basket stretchers to help with safe extrication from difficult positions.

Product Codes

PARA91	Lifting bridle - adjustable legs
--------	----------------------------------

Spine boards



Features

These durable polyethylene (PE) plastic spine boards can be used with safety belts and head immobilisers, and can also be x-rayed. Various options of stretcher straps available, ask us for details.

Dimensions: 184cm x 45cm x 7cm

Weight: 7kg

Max Load: 159kg

Product Codes

PARA29A	Spine board
---------	-------------

PARA29B	Spine board
---------	-------------

PARA29C	Spine board
---------	-------------

- Our lightweight, PE plastic spine boards are compact, easy to store, and X-ray translucent.

Rescue recovery stretcher



Features

The rescue recovery stretcher is an ultra-portable extremely flexible system. Ideal for search and rescue teams, it is particularly useful in situations where a fast recovery from difficult terrain is required.

- Inert to all conditions and body fluids
- Rolls up for easy storage and carrying in a backpack
- Extensive strapping to secure patient

Weight: 8kg

Max Load: 200kg

Product Codes

PARA40R	Rescue recovery stretcher
---------	---------------------------

Complete immobilisation system

Features

This kit contains everything you need to safely immobilize and move a patient. Ideal for situations where neck and back injuries are a possibility. The kit includes:

- Spine board (PARA29C)
- Head Immobilizer (PARA14)
- Spiderharness (PARA007)
- Bag - can also be used as a body bag (PARA005B)

Naturally, each component can also be purchased separately.

Product Codes

PARA27 Complete Immobilisation System



Manual handheld suction device



Features

This simple, compact suction device can be used in emergency situations to extract fluids from a patient. Includes a removable 300ml capacity container.

Product Codes

PARA01 Manual Handheld Suction Device

Body splint



Features

The body splint enables you to stabilise the patient's central body using a system of rigid bars and straps. Can be adjusted to fit a wide variety of body shapes.

Product Codes

PARA32 Body Splint

Head immobiliser



Features

High-density foam head block, designed to be used with spine boards and scoops. Features include:
 Large ear holes to improve communication with patient and enable monitoring of ear canal.
 Multiple straps for securing to stretcher.
 Waterproof plastic coating.
 Easy to clean.
 X-ray, CAT and MRI compatible materials.
 Dimensions: 42cm x 26cm x 18cm
 Weight: 0.7kg

Product Codes

PARA14 Head Immobiliser

Standard cervical collar



Features

Adjustable collar designed to be used on a wide range of patient head and neck sizes. Features include:
 Four height settings.
 X-ray, CAT and MRI compatible materials.
 Locking system to ensure the set position will not change after fitting.

Product Codes

COLNECADJA Standard Cervical Collar

Ambu® Perfit ACE™ premium cervical collar



Features

Premium adjustable collar. Features include:
 Four standard adult size settings plus 16 precise settings.
 X-ray, CAT and MRI compatible materials.
 Twin locking system to ensure the set position will not change after fitting.

Product Codes

COLNECADJB Adult Premium Cervical Collar

COLNECADJP Pediatric Premium Cervical Collar

Evaluation rescue stair chair



Features

Designed for patients with minor injuries that may prevent them from walking unaided. Makes easy work of moving patients down stairs and over obstacles.
 Folded size: 90cm x 54cm x 17cm
 Expanded size: 70cm x 52cm x 91cm
 Weight: 8kg
 Max Load: 159kg

Product Codes

PARA26CHAIR Evacuation Rescue Stair Chair

Key ring seatbelt cutter + window breaker



Features

Each sold separately.
Note: available colours subject to change without notice.

Product Codes

PARA71 Key Ring Seat Belt Cutter + Window Breaker

Help-it 'Blaze Breaker' fire blanket



Features

Our burn blankets measure 1.2m x 1m and 1.8m x 1.2m. Compact for easy storage. Wall hangable. (Pull release tabs to deploy.)

Product Codes

BLABURN1.2MX1.2M Fire Blanket 1.2m x 1.2m

BLABURN1.8MX1.2M Fire Blanket 1.8m x 1.2m

Fire extinguisher



Features

ABE Powder Fire Extinguisher.
 Available in multiple sizes.
 Ideal for your vehicle or boat.
 Great addition to your camping equipment
 Wall mountable.
 Our standard size is 1kg. Other sizes available on request.

Product Codes

FIREXTV0.3 Fire Extinguisher - 0.3kg Dry Powder

FIREXTV01 Fire Extinguisher - 1kg Dry Powder

FIREXTV1.5 Fire Extinguisher - 1.5kg Dry Powder

FIREXTV02 Fire Extinguisher - 2.5kg Dry Powder

FIREXTV03 Fire Extinguisher - 4.5kg Dry Powder

FIREXTV04 Fire Extinguisher - 9kg Dry Powder

High visibility orange day/night vest



Features

Our High Visibility Orange Day/Night vests feature retro-reflective 50mm silver tape, sturdy plastic front zip and breast pocket.

Complies with AS/NZS 4602.1:2011 and TTMC-W17 transit standards.

QSi offer a range of standard labelled reflective vests (see below), as well as a custom graphics service. We can apply the text of your choice to the front and/or back of the vest in a range of colour options including reflective silver.

Vests also available in lime yellow, and in day-only without reflective tape.

Sizes available: Small to 6XL. Also available in 8XL.

Product Codes

VESHIVISO-MA__	Orange Hi-Viz Marshal Vest
VESHIVISO-FA__	Orange Hi-Viz First Aid Medic Vest
VESHIVISO-SM__	Orange Hi-Viz Site Manager Vest
VESHIVISO-V__	Orange Hi-Viz Visitor Vest
VESHIVISO-W__	Orange Hi-Viz Warden Vest



Custom reflective text and graphics



Features

QSi want you and your team to stand out from the competition and be noticed.

We offer a flexible customising service, allowing your logo and the text of your choice to be heat set onto your team's garments in durable reflective vinyl.

Talk to us today about the various options available.

Flame retardant reflective tape

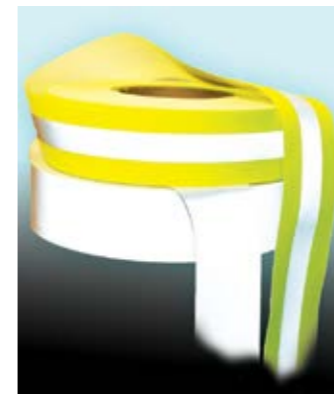

Features

Available in Silver and Striped Yellow/Silver. Fire resistant, washable and water resistant. 50mm wide.

Silver: 500 cd/lux

Yellow/Silver Striped: 380-410 cd/lux

Compliant with: NFPA, EN469, EN14116, EN471, ANSI

Product Codes

TAPREFSILFR50	Flame Retardant Tape - Silver
TAPREFYELFR50	Flame Retardant Tape - Yellow/Silver

Reflective sew-on tape



Features

Available in Silver. Washable, water resistant, highly reflective fabric. 50mm wide.

500 cd/lux

65% Polyester, 35% Cotton

Compliant with: ANSI, ISEA 107 2004

Product Codes

TAPREFSIL50	Reflective Sew-On Tape
-------------	------------------------

Arm bands



Features

QSi has a range of Velcro adjustable armbands designed to help identify specific people and roles within your organisation. We offer a unique customising service and can supply armbands with your specified wording and size. See below for our range of standard stock armbands.

Product Codes

ARBANDRED(FIRSTAIDMEDIC)	First Aid Medic arm band
ARBANDGREEN(FIREWARDEN)	Fire Warden arm band
ARBANDYELLOW (BUILDINGWARDEN)	Building Warden arm band
ARBANDGREEN (EMERGENCYSUPERVISOR)	Emergency Management Supervisor arm band
ARBANDYELLOW(VISITOR)	Visitor arm band
ARBANDGREEN(WARDEN)	Warden arm band
ARBANDRED(MEDIC)	Medic arm band
ARBANDYELLOW(MARSHAL)	Marshal arm band



➤ help-it.
spill solutions

spill solutions

Be prepared with Help-it Spill Solutions

When emergencies happen, you need to be prepared. No matter where you are, you need to know you can respond when faced with a spill.

Help-It Spill Solutions include a choice of natural or synthetic absorbent products. We have a wide variety of booms, socks, pads and pillows in various sizes and lengths to suit most types and sizes of spill. We also supply loose absorbent material.

Help-It Spill Kits contain the products and tools you need to safely contain a spill, including basic safety equipment for the user and enough absorbent product to deal with a specific size of spill, ranging from 25 to 240 Litres.



Help-It ANA-Fibre - the ultimate environmentally friendly spill solution.

Oil and chemical spills are some of the worst disasters man can inflict on the planet. Thankfully, mother nature has provided us with a perfect antidote: Help It Activated Natural Absorbent Fibre, or ANA-Fibre.

Key Features:

Highly absorbent - absorbs up to 4 times its dry weight in volume. One kilogram of fibre will absorb 3-5 litres of hydrocarbons.

Highly versatile - absorbs a vast range of pollutants including oils, pesticides, solvents, alcohol, effluents, heavy metals, inks, dyes, algae and a wide range of other chemicals and industrial wastes.

Fast acting - absorption for most hydrocarbons is almost instantaneous on contact. Some chemical spills may take a little longer.

Water resistant - can be used on water and in wet areas.

Suppresses vapours - helps prevent fire and explosions, and reduces risk to personnel from inhalation of toxic fumes.

Will not leak - the fibre will not leach or discharge the absorbed pollutant making it clean and easy to handle.

Environmentally Friendly - as well as being made from a natural, renewable source, ANA-Fibre can be incinerated or disposed of in landfills without damaging the environment. It can even be made into compost! Over time, ANA-Fibre slowly breaks down the absorbed contaminants and gradually releases them harmlessly

into the environment. When incinerated, the resulting residue is only 4% of its original volume.

Light Weight - allows the user to carry more product, clean up more spill, and save on transportation and disposal costs.

Why it works:

Help-It ANA-Fibre is harvested in New Zealand and is naturally occurring. After treatment the natural moisture content is reduced to around 10-15% and the cellular structure of the fibre is altered to become completely hydrophobic (water resistant) while becoming highly absorbent of hydrocarbons and chemicals.

The refined fibre is then packaged loose in carry-bags, distributed in bulk, or used in our unique socks, pillows and booms for instant spill containment.

ANA-Fibre filled socks



Features

These socks are designed to encircle spills, both absorbing the contaminant and ensuring the spill does not spread. They can also be floated on water.

Product Codes

ABSFIBSK1.2	1.2m x 6cm Sock
ABSFIBSK2.4	2.4m x 6cm Sock
ABSFIBSK3.0	3m x 6cm Sock
ABSFIBSK3.6	3.6m x 6cm Sock

ANA-fibre filled pillows



Features

Our pillows are perfect for taking care of drips (and lining drip trays) or soaking up pooled spills.

Product Codes

ABSFIBPW35X20	Small Pillow (35x20cm)
ABSFIBPW60X40	Large Pillow (60x40cm)

ANA-fibre filled booms



Features

Big brother to the socks, ANA-Fibre filled booms can be used to dam large spills on water ways while absorbing vast amounts of contaminant.

Product Codes

ABSFIBBM3X13	Thin Boom (3m x 13cm)
ABSFIBBM3X18	Thick Boom (3m x 18cm)

ANA-fibre



Features

Loose ANA-Fibre packaged in sturdy plastic bags. Designed to be poured onto a spill to soak up oil or chemicals.

When placed on hydrocarbon-contaminated water, it will float and naturally clump together as it absorbs the spill, making it easy to scoop from the water.

Will absorb up to five times its dry body-weight in litres of contaminant.

Product Codes

ABSFIB3	ANA-Fibre - 15Lt approx absorption capacity (Bag volume approx 10Lt)*
ABSFIB5	ANA-Fibre - 25Lt approx absorption capacity (Bag volume approx 16.5Lt)*
ABSFIB15	ANA-Fibre - 75Lt approx absorption capacity (Bag volume approx 50Lt)*
ABSFIB25	ANA-Fibre - 125Lt approx absorption capacity (Bag volume approx 100Lt)*

Granular absorbent



Features

Granular absorbent packaged in sturdy plastic bags. Designed to be poured onto a spill to soak up oil or chemicals. Will absorb up to 70% of its dry body-weight.

Product Codes

ABSGRAN5KG	7.9L Standard Loose Granular Absorbent (approx 5kg)
ABSGRAN15KG	22L Standard Loose Granular Absorbent (approx 15kg)

Large plastic shovel



Features

Large plastic shovel designed for cleanup of spill absorption products such as ANA-Fibre and Granular Absorbent.

Product Codes

PLASSHOVEL	Large Plastic Shovel
------------	----------------------

Synthetic pads - oil**Features**

These absorbent pads are used to soak up surface spills, contain drips, etc. They are available in packs of five, or in bulk and come in two weights.

Product Codes

ABSPADOIL200G5PK	Light Synthetic Absorbent Pad 200gsm (5-Pack)
ABSPADOIL200GBOX	Light Synthetic Absorbent Pad 200gsm (Box 200)
ABSPADOIL400G5PK	Heavy Synthetic Absorbent Pad 400gsm (5-Pack)
ABSPADOIL400GBOX	Heavy Synthetic Absorbent Pad 400gsm (Box 100)

Synthetic socks - oil**Features**

Designed to encircle, dam and absorb spills. Suitable for boat bilges, around drums and other containers.

Product Codes

ABSSYNOLSK1.2M	1.2m x 7cm Sock
ABSSYNOLSK2.4M	2.4m x 7cm Sock
ABSSYNOLSK3M	3m x 7cm Sock

Synthetic pillow - oil**Features**

These pillows will soak up large spills and can be used as temporary plugs.

Product Codes

ABSSYNOLPILLMD	Medium Synthetic Absorbent Pillow (35 x 25 x 2cm)
ABSSYNOLPILLLG	Large Synthetic Absorbent Pillow (40 x 50 x 5cm)

Synthetic booms - oil**Features**

Help-It synthetic absorbent booms feature robust stainless steel clips making it easy to join up multiple overlapping booms.

Product Codes

ABSSYNOLBM12X3M	Medium Synthetic Absorbent Boom (12cm x 3m)
ABSSYNOLBM20X3M	Large Synthetic Absorbent Boom (20cm x 3m)

Synthetic roll - oil**Features**

Perforated at 25cm intervals for easy tearing - no scissors required. Also perforated at 30cm and 60cm across the width of the roll.

Ideal for use under vehicles by mechanics, on table tops, and anywhere oil spillage is possible.

Product Codes

ABSSYNOIROLL250	Absorbent Synthetic Oil Roll 50cm x 40m 250gsm
ABSSYNOIROLL400	Absorbent Synthetic Oil Roll 50cm x 40m 400gsm
ABSSYNOILROLL	Absorbent Synthetic Oil Roll 90cm x 40m 400gsm

Oil drum top absorbent pad**Features**

A perfect solution for the chronic mess that collects on the top of oil drums, these pads keep them clean and easy to use. Designed to fit standard 44 gallon drums, with spaces pre-cut for filler and breather holes.

Mini pads for filler and breather holes included.

Product Codes

ABSSYNOLDRUM	Oil Drum Top Absorbent Pad
--------------	----------------------------

Wheelie bin cover**Features**

A perfect solution for the chronic mess that collects on the top of oil wheelie bins.

Custom branding also available.

Available colours: Yellow, green, red

Product Codes

WHLBIN120COV	120L Wheelie Bin Cover
WHLBIN240COV	240L Wheelie Bin Cover

Synthetic pads - chemical



Features

These absorbent pads are used to soak up surface spills, contain drips, etc. They are available in packs of five, or in bulk.

Product Codes

ABSPADCHEM400G5PK	Large Synthetic Absorbent Pad - 400gsm (5-Pack)
ABSPADCHEM400GBOX	Large Synthetic Absorbent Pad - 400gsm (Box of 100)

Synthetic socks - chemical



Features

Designed to encircle, dam and absorb spills.

Product Codes

ABSSYNCHEMSK1.2M	1.2m Sock
ABSSYNCHEMSK2.4M	2.4m Sock
ABSSYNCHEMSK3M	3m Sock

Synthetic pillow - chemical



Features

Designed to absorb chemical spills.

Product Codes

ABSSYNCHEMPILLMD	Absorbent Chemical / GP Pillow Medium - 35 x 25cm
ABSSYNCHEMPILLLG	Absorbent Chemical / GP Pillow Large - 40 x 50cm

Synthetic pad - general purpose



Features

These absorbent pads are used to soak up surface spills, contain drips, etc. They are available in packs of five, or in bulk.

Product Codes

ABSPADGEN400G5PK	Large Synthetic Absorbent Pad - 400gsm (5-Pack)
ABSPADGEN400GBOX	Large Synthetic Absorbent Pad - 400gsm (Box of 100)

Synthetic socks - general purpose



Features

Designed to encircle, dam and absorb spills.

Product Codes

ABSSYNGENSK1.2M	1.2m Sock
ABSSYNGENSK3M	3m Sock

Synthetic pillows - general purpose



Features

Designed to absorb general purpose spills.

Product Codes

ABSSYNGENPILLLG	Large Synthetic Absorbent Pillow (40 x 50 x 5cm)
-----------------	--

ANA-fibre & granular absorbency rates chart

Product Code	Product Description	*Absorbency (Approx. Litres)
ABSFIBSK1.2	ANA-Fibre 1.2m x 6cm sock	5L
ABSFIBSK2.4	ANA-Fibre 2.4m x 6cm sock	10L
ABSFIBSK3.0	ANA-Fibre 3m x 6cm sock	12.5L
ABSFIBSK3.6	ANA-Fibre 3.6m x 6cm sock	15L
ABSFIBPW35X20	ANA-Fibre Small Pillow (35 x 20cm)	2L
ABSFIBPW60X40	ANA-Fibre Large Pillow (60 x 40cm)	7L
ABSFIBBM3X13	ANA-Fibre Thin Boom (3x13cm)	8.5L
ABSFIBBM3X18	ANA-Fibre Thick Boom (3 x 18cm)	17L
ABSFIB3	ANA-Fibre bag volume approx 10L	15L
ABSFIB5	ANA-Fibre bag volume approx 16.5L	25L
ABSFIB15	ANA-Fibre bag volume approx 50L	50L
ABSFIB25	ANA-Fibre bag volume approx 100L	125L
ABSGRAN5KG	Granular Absorbent 7.9L Standard Loose	50L
ABSGRAN15KG	Granular Absorbent 22L Standard Loose	150L

Oil & fuel absorbency rates chart

Product Code	Product Description	*Absorbency (Approx. Litres)
ABSSYNOLBM12X3M	Absorbent Synthetic Oil Boom 12cm x 3m	33L
ABSSYNOLBM20X3M	Absorbent Synthetic Oil Boom 20cm x 3m	75L
ABSPADOIL400GBOX	Absorbent Oil Pad 400gsm (Each=1/Box=100)	1.5L per pad, 150L per box
ABSPADOIL200GBOX	Absorbent Oil Pad 200gsm (Each=1/Box=200)	0.75L per pad, 75L per box
ABSSYNOLSK1.2M	Absorbent Synthetic Oil Sock 1.2m	6.4L
ABSSYNOLSK2.4M	Absorbent Synthetic Oil Sock 2.4m	12.8L
ABSSYNOLSK3M	Absorbent Synthetic Oil Sock 3m	16L
ABSSYNOLPILLG	Absorbent Synthetic Oil Pillow Large 40x50cm	8L
ABSSYNOLPILLMD	Absorbent Synthetic Oil Pillow Medium 35x25cm	3.5L
ABSSYNOLDRUM	Absorbent Oil Drum Top Pad	1L
ABSSYNOLROLL250	Absorbent Synthetic Oil Roll 50cm x 40m 250gsm	90L
ABSSYNOLROLL400	Absorbent Synthetic Oil Roll 50cm x 40m 400gsm	140L
ABSSYNOLROLL	Absorbent Synthetic Oil Roll 90cm x 40m	260L

Chemical absorbency rates chart

Product Code	Product Description	*Absorbency (Approx. Litres)
ABSPADCHEM400BOX	Absorbent Chemical Pads 400gsm (Each=1/Box=100)	1.2L per pad, 120L per box
ABSSYNCHEMSK1.2M	Absorbent Synthetic Chemical Sock 1.2m	5.5L
ABSSYNCHEMSK2.4M	Absorbent Synthetic Chemical Sock 2.4m	11L
ABSSYNCHEMSK3M	Absorbent Synthetic Chemical Sock 3m	16L
ABSSYNCHEMPILLG	Absorbent Chemical Pillow Large 40x50cm	7L
ABSSYNCHEMPILLMD	Absorbent Chemical Pillow Medium 35x25cm	2.9L

General purpose absorbency rates chart

Product Code	Product Description	*Absorbency (Approx. Litres)
ABSPADGEN400BOX	Absorbent General Purpose Pads 400gsm (Each=1/Box=100)	1.2L per pad, 120L per box
ABSSYNGENSK1.2M	Absorbent Synthetic General Purpose Sock 1.2m	5.5L
ABSSYNGENSK3M	Absorbent Synthetic General Purpose Sock 3m	16L
ABSSYNGENPILLG	Absorbent General Purpose Pillow Large 40 x 50cm	7L

* Note - Absorption capacity can vary according to the viscosity of the liquid to be absorbed, physical location of the spill and relative humidity.

Spill block PVC socks



Features

Robust PVC sock containing heavy particulate. Designed to block and direct the path of spills, not absorb them. Can be made to order at any size.

Product Codes

ABSBLKSK1.2	Spill Block PVC Sock - 1.2m x 6cm
ABSBLKSK2.4	Spill Block PVC Sock - 2.4m x 6cm

Spill block drain mats



Features

These mats are designed to be placed over storm water (and other) drains to prevent contamination of water ways etc.

Product Codes

ABSBLKMAT3.5	Thin Spill Block Drain Mat 750 x 1000 x 3.5mm
--------------	---

Spill block carry bag



Features

Robust carry bag for Spill Block Socks and Drain Mats.

Product Codes

ABSBLKBAG	Spill Block Carry Bag
-----------	-----------------------

Plug & dike



Features

Plug and control the leak at the source. A non-toxic material which forms a seal when used to plug a punctured storage or transport container. Seals off gasoline, diesel, solvents and other chemicals.

Product Codes

ABSPD500G	Plug & Dike in container 500g
-----------	-------------------------------

Spill drain guard



Features

Designed to be placed over drain inlets to catch any residual debris not caught by pads and drain mats.

Product Codes

DRAINGUARDS	Drain Guard 1.2 x 1.2m
-------------	------------------------

Help-it spill kits

These kits are packed with everything you need for the efficient containment of spills. We have a range of sizes to suit varying levels of risk and types of contaminant. Most kits contain the following tools to aid the user: clean-up bags, basic personal protection equipment, gloves, basic instructions.

Unlike some of our competitors, we have measured the absorption of the products in each kit to ensure they will absorb up to the number of litres indicated on the kit. This figure does not represent the physical volume of the kit container.

Every spill kit purchased comes with our comprehensive Spill Kit Guide booklet that contains information on the best products and methods to prepare for, clean up, and dispose of your spills.



NOTE - Contents of our spill kits may vary in contents and branding from time to time, however we will never compromise on quality and absorption rates.



15L oil (hydrocarbon) spill kit



Features

This kit is designed to absorb up to 15 litres of contaminant. The kit is compact enough to fit behind the seat of a truck or ute and makes a great first line of defence.

Product Codes

ASKVEH	15L oil vehicle spill kit
ASKVEHRF	Refill pack

25L oil (hydrocarbon) spill kit



Features

This kit is designed to absorb spills up to 25 litres. It is compact enough to fit behind the seat of a truck or ute. The 'WPB' version comes in a yellow waterproof dry-bag.

Product Codes

ASK25OIL	25L oil (hydrocarbon) spill kit
ASK25OILWPB	25L oil spill kit in waterproof bag
ASK25OILRF	Refill pack

50L oil (hydrocarbon) spill kit



Features

This kit is designed to absorb up to 50 litre spills.

Product Codes

ASK50OIL	50L oil (hydrocarbon) spill kit
ASK50OILRF	Refill pack

80L oil (hydrocarbon) spill kit



Features

This kit is designed to absorb large spills up to 80 litres.

Product Codes

ASK80OIL	80L oil (hydrocarbon) spill kit
ASK80OILRF	Refill pack

120L oil (hydrocarbon) spill kit



Features

This kit is designed to absorb large spills up to 120 litres. Wheelie bin provides storage of the kit before use, aids transport of kit to spill site and makes disposal of used items easy.

Product Codes

ASK1200IL	15L oil vehicle spill kit
ASK1200ILRF	Refill pack

240L oil (hydrocarbon) spill kit - economy



Features

This kit is designed to absorb extra large spills up to 240 litres. Wheelie bin provides storage of the kit before use, aids transport of kit to spill site and makes disposal of used items easy.

Product Codes

ASK240E0IL	240L oil spill kit - economy
ASK250ILWPB	Refill pack

240L oil (hydrocarbon) spill kit - premium



Features

This premium kit is designed to absorb a wide range of different sized spills up to 240 litres. Added extra socks and pillows, plus smaller bags of loose fibre so a number of smaller spills can be contained without having to open and use everything in the kit at once.

Product Codes

ASK240P0IL	240L oil spill kit - premium
ASK240P0ILRF	Refill pack

30L chemical spill kit



Features

This kit is designed to absorb up to 30 litres of chemicals.

Product Codes

ASK30CHEM	30L chemical spill kit
ASK30CHEMRF	Refill pack

50L chemical spill kit



Features

This kit is designed to absorb up to 50 litres of chemicals.

Product Codes

ASK50CHEM	50L chemical spill kit
ASK50CHEMRF	Refill pack

120L chemical spill kit



Features

This kit is designed to absorb up to 120 litres of chemical spills. Wheelie bin provides storage of the kit before use, aids transport of kit to spill site and makes disposal of used items easy.

Product Codes

ASK120CHEM	120L chemical spill kit
ASK120CHEMRF	Refill pack

240L chemical spill kit



Features

This kit is designed to absorb up to 240 litres of chemicals. Wheelie bin provides storage of the kit before use, aids transport of kit to spill site and makes disposal of used items easy.

Product Codes

ASK240CHEM	240L chemical spill kit
ASK240CHEMRF	Refill pack

30L general purpose spill kit



Features

This kit is designed to absorb up to 30 litres of general liquid spills.

Product Codes

ASK30GPS	30L general purpose spill kit
ASK30GPSRF	Refill pack

50L general purpose spill kit



Features

This kit is designed to absorb up to 50 litres of general liquid spills.

Product Codes

ASK50GPS	50L general purpose spill kit
ASK50GPSRF	Refill pack

120L general purpose spill kit



Features

This kit is designed to absorb up to 120 litres of general liquid spills. Wheelie bin provides storage of the kit before use, aids transport of kit to spill site and makes disposal of used items easy.

Product Codes

ASK120GPS	120L general purpose spill kit
ASK120GPSRF	Refill pack

240L general purpose spill kit



Features

This kit is designed to absorb up to 240 litres of general liquid spills. Wheelie bin provides storage of the kit before use, aids transport of kit to spill site and makes disposal of used items easy.

Product Codes

ASK240GPS	240L general purpose spill kit
ASK240GPSRF	Refill pack

2 drum workflow



Features

Low-profile workflow designed to catch spillage from drums. Can be fitted with ramp to aid access. (Ramp sold separately.) Fits up to two standard oil drums. Dimensions: 800 x 1600 x 150mm Sump size: 121L | Load rating: 1350kg

Product Codes

SPCWF-2D	2 Drum Workflow
----------	-----------------

4 drum workflow



Features

Low-profile workflow designed to catch spillage from drums. Can be fitted with ramp to aid access. (Ramp sold separately.) Fits up to four standard oil drums. Dimensions: 1600 x 1600 x 150mm Sump size: 239L | Load rating: 2700kg

Product Codes

SPCWF-4D	4 Drum Workflow
----------	-----------------

2 drum spill pallet



Features

The spill pallet is designed to be lifted and moved safely and easily by forklift, while catching spillage from drums. Fits up to two standard oil drums. Dimensions: 1300 x 750 x 440mm Sump size: 250L | Load rating: 1350kg

Product Codes

SPCP-2D	2 Drum Spill Pallet
---------	---------------------

4 drum spill pallet



Features

The spill pallet is designed to be lifted and moved safely and easily by forklift, while catching spillage from drums. Fits up to four standard oil drums. Dimensions: 1380 x 1290 x 280mm Sump size: 250L | Load rating: 2700kg

Product Codes

SPCP-4D	4 Drum Spill Pallet
---------	---------------------

Work floor ramp



Features

Allows hassle-free access to the Work Floor units. Features integrated locking pins and an easy gradient with a non-slip surface. (Ramp only)

Dimensions: 810 x 1290 x 180mm
Load rating: 300kg

Product Codes

SPCWF-RAMP	Work floor ramp
------------	-----------------



cinch

premium height
safety equipment

Quality born from experience

QSi has been designing and manufacturing premium quality height safety equipment for over 40 years, drawing on over 70 years of safety experience. Our many years of experience in manufacturing has given us a reputation for innovative product development.

We manufacture many of our height safety products right here in New Zealand, in our ISO9001 approved factory, so we have direct control over the quality and can easily scale our output to meet demand with the minimum of lead time.

Many other customer benefits are achieved by manufacturing and testing in New Zealand, including work-specific products, current dates, and ongoing surveillance of products.

We also source directly from the world's best manufacturers, made to our own exacting standards.

All QSi products are certified to either the AS/NZS 1891 or equivalent industry acceptable standards where applicable.



Manufactured & tested in New Zealand

QSi are accredited by IANZ to test height safety gear to the AS/NZS 1891.1:2007, AS/NZS 1891.3 and AS/NZS 5532 standards. This means every product we make has been tested to the most stringent standards.

We also have Telarc ISO 9001 certification, BSI product benchmark certification (on various products), as well as CASA approval as a manufacturing facility for aviation harnesses

It also means we're more than just a "visual inspector" - we don't just look at gear, we put it through its paces to ensure it's fit for purpose and won't let you down.

Having our own testing facility on site gives us the unique opportunity to take our products to the limit multiple times throughout the development process instead of relying on fewer, more expensive tests in a foreign lab.

This allows us to identify and solve problems quickly, greatly reducing development costs, resulting in a better and more affordable product for our customers.

Flexibility & affordability

Customising is our speciality. We love to work alongside our customers to develop tailor-made products that meet their unique requirements. We're not here to tell you what you need, we're here to listen, collaborate, and find solutions.

This begins with custom printed bags, lanyard and harness labels with your company logo, and extends through to custom designed harnesses specific to the needs of you and your industry.

Understanding New Zealand's height safety standards

Height safety is largely a matter of trust. As users, we trust that our equipment has been subjected to rigorous testing and meets the required safety standards. Understanding height safety equipment standards can be difficult for distributors, resellers and consumers alike.

There has been much confusion and misunderstanding of the AS/NZS 1891 group of standards relating to height safety products in New Zealand. It has become apparent that some manufacturers have been marking product to non-existing testing standards, and possibly misleading consumers as a result. Added to this, WAHA Australia have recently uncovered issues with roof anchors and fixed life line systems not meeting the new AS/NZS 5532:2013 standard.

QSI has been working hard to become one of the first IANZ accredited facilities in New Zealand to test to the AS/NZS 1891.1:2007 and AS/NZS 1891.3 standards. This has taken over 3 years to achieve, but has given us much insight into the testing and marking of products to this set of standards.

EN versus AS/NZS Standards

Some importers of product mark their harnesses, shock absorbing lanyards and pole straps to both the EN and AS/NZS 1891.1:2007 standards on the same product. We are often asked, "what is the difference between the AS/NZS 1891.1:2007 standard and the equivalent EN standards?"

The table on the following page details some distinct differences.

It will not be possible for an EN labelled product's test certificate to pass the AS/NZS 1891.1:2007 standard as they could not possibly meet the labelling and marking

requirements, just as it would not be possible for the AS/NZS 1891.1:2007 product to meet the EN standard because the marking, labelling and instructions are different.

There is nothing wrong with EN certified product and we at QSI sell and use EN product ourselves. The only difference is that we market it as having the 5 year life span it conforms to, unless we have a UV certificate showing the webbing complies to the AS/NZS UV testing requirements.

AS/NZS 1891.4 is not a Testing Standard

Another big area of concern is the tendency of some companies to mark products to the AS/NZS 1891.4 standard. Although this falls under the family of testing standards, it in itself is not actually a testing standard, but rather a user selection and maintenance guide.

The most common products marked with this standard are anchor points and slings, but we have also seen some harnesses and pole straps marked this way.

The 1891.4-2009 standard clearly states it is for selection, use, and maintenance. If you asked QSI Testing Laboratory to test to this standard we would tell you it is impossible as there are no testing specifications and methods of testing laid out in this document. Furthermore, Section 1.5 of the standard states that compliance to the standard cannot be claimed on any product.

The criteria of section 1.5 of AS/NZS 1891.4 2009 is as follows:

1.5 PERFORMANCE REQUIREMENTS

This Standard does not include product performance requirements for height safety equipment. Compliance to this Standard of any such equipment cannot be claimed.

Performance requirements with which items of equipment dealt within this Standard shall comply are specified in AS/NZS 1891, Parts 1, 2 and 3.

If you have product marked or bearing the mark of the AS/NZS 1891.4 standard, or claiming to be tested to and complying to the AS/NZS 1891.4 standard, the product should be examined carefully as it is not possible to test to this standard. Any document claiming to be a test certificate to this standard is likely to be incorrect.

The new AS/NZS 5532:2013 standard is a part of the AS/NZS 1891 group and deals with tripods, davit arms, and both temporary and fixed anchor points. The standard was published in late 2013.

It is important that distributors, resellers, end-users and their employers are educated on what the standards cover. The difficulty of obtaining information about the standards has resulted in some users being misled into thinking certain products meet a nonexistent standard. If anyone feels a product is not up to standard they have the right to ask for the testing certificates, and each model of height safety equipment is required to have its own testing certificate.

As users, resellers and distributors become more savvy and better educated on the details of the AS/NZS and EN standards, we hope to see a greater level of compliance for all height safety equipment sold in New Zealand. In the meantime, we advise consumers to be vigilant and not take any manufacturer's claims at face value. Ask questions, ask for certificates, double-check, and get educated; after all, your life and your business could depend on it.



Key differences between EN and AS/NZS high safety standards

Test criteria	AS/NZS 1891.1:2007 Standard	EN Standard
UV Testing and Lifespan	We are required to conduct a determination of resistance of webbing to light test as per Appendix A of AS/NZS 1891.1:2007. This gives us our 10-year life span on webbing products certified to the AS/NZS 1891.1:2007 standard. Actual certificate is needed on the webbing, not the thread.	EN standards do not require UV testing as the product is only required to last 5 years.
Dynamic Drop Testing	The AS/NZS 1891.1:2007 dynamic drop test is conducted on a 2m x 12mm diameter, three-strand, polyester hawser-laid rope. Each harness will have a 'head-up' and 'head-down' drop on the fall arrest attachment points. On a head-up drop it will generate over 12kN of force during the drop and the head-down could be as much as 16kN to 18kN. The AS/NZS standard does not specify a force requirement that the harness needs to be exposed to, but the force generally exceeds the 12kN load due to the lack of stretch in the polyester rope. Thus, most of the energy ends up in the harness.	The EN 364 standard requires a single mountaineering rope of 11mm diameter. This is known as kernmantle rope and has more stretch in it than the 12mm polyester rope. The EN test also requires a head-up and head-down drop on the fall arrest attachment points. If the testing facility uses dynamic mountaineering rope, this has a lot of stretch to allow for some shock absorption during a climber's fall, this is why the EN standard specifies a minimum force requirement of 7.5kN that needs to be achieved on the first drop.
Marking and Labelling	The marking and labelling requirements as per AS/NZS 1891.1:2007 section 6.1 (Instructions for use) and section 6.2 (marking) are very specific on font size, label layout, and details that need to be included in the warning labels as well as the instruction book. The AS/NZS 1891.1:2007 product needs a clear date of withdrawal.	The EN requirements are vastly different in terms of labelling and instructions for use, even to the point of using an "A" symbol to indicate the fall arrest attachment point. The EN product only requires a date of manufacture. The 5 year life is standard unless specified differently by the manufacturer on the basis of a UV certificate.

Height safety training & gear inspection

Our drop test tower and classroom space are regularly used by external training organisations as a venue for height safety training courses.

If you or your team members need to attend an accredited training course but are not sure where to start, feel free to contact us and we'll put you in touch with an appropriate provider.

All height safety gear must be inspected by a competent person on a regular basis as required by the AS/NZS 1891.4 standard:

- **Harnesses, lanyards, pole straps, etc:** six monthly. (All products covered by the AS/NZS 1891.1 standard)
- **Retractable lanyards:** Annually. (All products covered by the AS/NZS 1891.3 standard)

If a suitable person cannot be found in your organisation, or if you prefer to leave this up to the experts, we recommend you take advantage of QSI's visual inspection service.*

Email info@qsisafety.com for more information.

* Please note: The six monthly or annual inspection is not a substitute for daily checks.



Selecting the correct fall protection equipment

The A, B, C, D of fall protection covers all the fundamental points of personal fall protection, but before you can use or select the correct equipment you need to be adequately trained. There are dedicated NZQA and AQTF training courses focusing on height safety as well as best practice guidelines for working at height and on roofs in New Zealand and Australia.

A – Anchor

The anchor point is one of the critical elements of the fall arrest system. The AS/NZS 1891.4 guidelines state a single anchor point needs to be 15kN, and 21kN if two users are attached to the same point.

B – Body support

Full body harnesses are what connects the user to the fall arrest system and they come in a variety of styles. The AS/NZS 1891.1:2007 standards differ from other international standards as they have been written to ensure the product conforms to the higher UV levels experienced in Australasia as well as having a minimum of two fall arrest attachment points (sternal and dorsal).

C - Connectors

Connectors are used to make the link between the body support and the anchor device, they come in various styles and configurations.

D – Descent and Rescue

In the event of a fall there must be a system or plan in place to allow the user to descend safely to the ground or be rescued without endangering the user or other colleagues.

Calculating fall clearance

Fall Clearance is the distance needed to safely arrest a fall so that the user does not strike an object below or the ground.

General Calculation:

(FC)	Fall Clearance	$FC = FFD + SA + WH + SF$
(FFD)	Free Fall Distance	Maximum length: 2m
(SA)	Maximum Length of Extended Shock Absorber	1.75m for standard unit 1.95m for 150kg unit
(WH)	Height of Worker	Average: 1.7m
(SF)	Safety Factor	Minimum: 1m

As per AS/NZS 1891.4 the Fall Clearance (FC) can be reduced by limiting the free fall distance (FFD) and reducing the amount of shock absorber tear out (SA).	FFD – Free Fall Distance	SA – Shock Absorber Ext.
	600mm	300mm
	1000mm	500mm
	1500mm	600mm
	2000mm	900mm

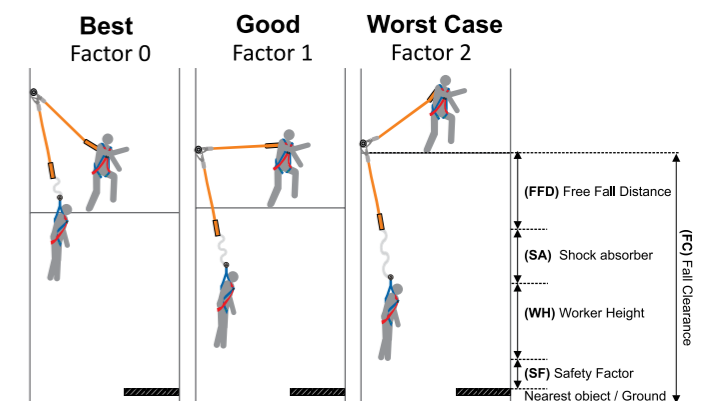

Fall Factor 0 Indicates that you have reduced as much free fall distance as possible by attaching your lanyard above you.

Fall Factor 1 Indicates your anchor point is at the same level as your attachment point on the harness. This means that you will potentially fall the full length of your lanyard (2m on a 2m lanyard).

Fall Factor 2 Is the worst case scenario, where you are anchored at your feet. This means you will fall up to twice the length of your lanyard. A total of 6.75m clearance would be required when using a 2m lanyard.

What's in the box?

Congratulations, you've made a great decision to invest in your safety with QSi height safety gear.

Before you make your purchase, check the sticker on the front of the box to make sure you've picked the product that's right for you.

Inside the box you'll find more than just great height safety gear. There are two important items that you must not throw away: The Product Instructions Booklet and Certificate of Conformity.



Product instructions booklet

This booklet contains donning and safe use instructions for QSi harnesses, lanyards and metal hardware. Find your product and read the instructions carefully - your life may depend on it.

Store the booklet with the equipment so anyone else who needs to use it can learn how to do so safely.



Certificate of conformity

This certificate is your guarantee that the product has been manufactured and tested to the appropriate AS/NZS or other applicable international standard.

All the key information for your particular product is recorded on the certificate including how often it should be inspected and when it should be withdrawn from service and disposed of.

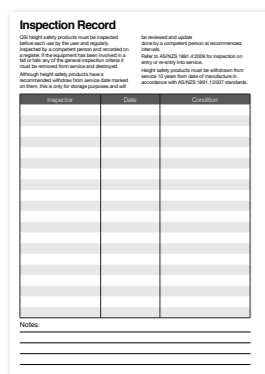

Inspection record

On the reverse side of the certificate you'll find an Inspection Record table, essential for the safe, long-term use of your equipment. AS/NZS 1891.4 requires that your gear is inspected regularly:

- Six-Monthly: Harnesses, lanyards, pole straps, etc (all products covered by the AS/NZS 1891.1 standard)
- Annually: Retractable lanyards (all products covered by the AS/NZS 1891.3 standard)

These inspections must be recorded in the Inspection Record on the back of the Certificate of Conformity as proof you comply with the standards and are adhering to workplace safety legislation.

Full body harness - SBE2 series

Features

Our standard Full Body Harnesses feature two attachment webbing loops and a dorsal attachment D-Ring for fall-arrest. The sternal attachment points are particularly suitable for use with rope or cable grabs and offer a comfortable position to work from as well as for rescue.

High strength, easy adjustment webbing buckles are used on both legs and chest. Other features include easy-grip shoulder adjustment buckles, webbing fall arrest loops and high strength stitch pattern.

The SBE2 is available in sizes 3XL and above for use in conjunction with a 150kg rated fall arrest block. See pg. 130 for more information.

Optional Extras:

- D-Ring Extension Strap
- X-Factor Shoulder Padding System
- AirTech Breathable Padding System (see pg. 129)
- Heavy Duty PVC Bags, Backpacks, etc (see pg. 156)
- Tool Lanyards and Pouches (see pg. 208)

Certified to: AS/NZS 1891.1:2007

Product Codes

SBE2	Full Body Harness
SBE2K	Full Body Harness with Lower Chest Loops
SBE2KQR	Full Body Harness with Lower Chest Loops and Quick Release Buckles
SBE2KQRPRO	Same specs as KQR model above, plus X-Factor Shoulder Padding

Optional accessories

SMALL & 3XL+
sizes available on request



Harness backpack

D-Ring extension strap

X-Factor shoulder padding system



SBE2



General Use



Construction



Mobile Platform



SBE2K



General Use



Construction



Mobile Platform



Roofing



SBE2KQRPRO



General Use



Construction



Mobile Platform



Roofing

SBE2KQRPRO is pictured with optional extension strap.

Full body harness with confined space loops - SBE3 series

Features

This harness takes all the great features of the SBE2 Full Body Harness and adds confined space loops to the shoulder straps to make it suited for workers in confined spaces. The loops can be used with a spreader bar during emergency retrieval situations to comfortably raise or lower the user.

The SBE3 is available in sizes 3XL and above for use in conjunction with a 150kg rated fall arrest block. See pg. 130 for more information.

Optional Extras:

- D-Ring Extension Strap
- X-Factor Shoulder Padding System
- AirTech Breathable Padding System (see pg. 129)
- Heavy Duty PVC Bags, Backpacks, etc (see pg. 156)
- Tool Lanyards and Pouches (see pg. 208)

Certified to: AS/NZS 1891.1:2007

Product Codes

SBE3	Full Body Harness with Confined Space Loops
SBE3K	Full Body Harness with Confined Space Loops and Lower Chest Loops
SBE3KQR	Full Body Harness with Confined Space Loops, Lower Chest Loops and Quick Release Buckles
SBE3KQRPRO	Same specs as KQR model above, plus X-Factor Shoulder Padding

Optional accessories

SMALL & 3XL+
sizes available on request



Harness backpack

D-Ring extension strap

X-Factor shoulder padding system



SBE3



General Use



Construction



Mobile Platform



Confined Space



SBE3KQR SBE3KQRPRO



General Use



Construction



Mobile Platform



Confined Space



Roofing

SBE3KQR is pictured.



SBE3K



General Use



Construction



Mobile Platform



Confined Space



Roofing

Full body harness with waist belt and work positioning D-rings - SBE4 series



SBE4



Features

This harness is the perfect choice for workers needing more stability, support and a hands-free solution.

QSi have added a sturdy waist belt and lateral D-Rings to allow the user full control over their positioning using a pole strap.

The SBE4 is available in sizes 3XL and above for use in conjunction with a 150kg rated fall arrest block. See pg. 130 for more information.

Optional Extras:

- D-Ring Extension Strap
- X-Factor Shoulder Padding System
- AirTech Breathable Padding System (see pg. 129)
- Heavy Duty PVC Bags, Backpacks, etc (see pg. 156)
- Tool Lanyards and Pouches (see pg. 208)

Certified to: AS/NZS 1891.1:2007

Product Codes

SBE4	Full Body Harness with Waist Belt and D-Rings, plus Lower Chest Loops and Quick Release Buckles.
------	--

Optional accessories

SMALL & 3XL+
sizes available on request



Harness backpack



D-Ring extension strap

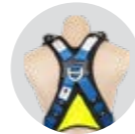

X-Factor shoulder padding system



SBE4KQRPRO



Features

The SBE4KQR model adds Quick Release Buckles in place of the standard buckles on chest, waist and leg straps, and gives you lower chest loops by swapping the position of the loops and shoulder strap adjustment buckles.

Optional Extras:

- D-Ring Extension Strap
- X-Factor Shoulder Padding System
- AirTech Breathable Padding System (see pg. 129)
- Heavy Duty PVC Bags, Backpacks, etc (see pg. 156)
- Tool Lanyards and Pouches (see pg. 208)

Certified to: AS/NZS 1891.1:2007

Product Codes

SBE4KQR	Full Body Harness with Waist Belt and D-Rings, plus lower Chest Loops and Quick Release Buckles
SBE4KQRPRO	Same specs as KQR model above, plus X-Factor Shoulder Padding

Optional accessories

SMALL & 3XL+
sizes available on request



Harness backpack

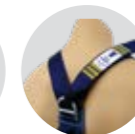

D-Ring extension strap

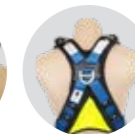

X-Factor shoulder padding system

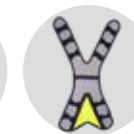

Full body harness with waist belt, D-Rings and confined space loops - SBE5 series

Features

The SBE5 combines all the great features of the SBE3 and SBE4, and adds a full padded waist belt for increased user comfort and support. Large D-Rings provide lateral stability and a hands-free solution using Work Positioning Lanyards, while confined space loops on the fully adjustable shoulder straps allow easy extraction from tight spaces.

The SBE5 and SBE5Rig are available in sizes 3XL and above for use in conjunction with a 150kg rated fall arrest block. See pg. 130 for more information.

Optional Extras:

- D-Ring Extension Strap
- X-Factor Shoulder Padding System
- AirTech Breathable Padding System (see pg. 129)
- Heavy Duty PVC Bags, Backpacks, etc (see pg. 156)

Tool Lanyards and Pouches (see pg. 208)

Certified to: AS/NZS 1891.1:2007

Product Codes

SBE5	Full Body Harness with Padded Waist Belt, D-Rings and Confined Space Loops
SBE5KQR	Full Body Harness with Padded Waist Belt, D-Rings and Confined Space Loops, plus Lower Chest Loops and Quick Release Buckles
SBE5KQRPRO	Same specs as KQR model above, plus X-Factor Shoulder Padding and Confined Space Loops removed
SBE5RIG	Full Body Harness with Padded Waist Belt, D-Rings, Confined Space Loops and Restraint Points

Optional accessories

SMALL & 3XL+
sizes available on request

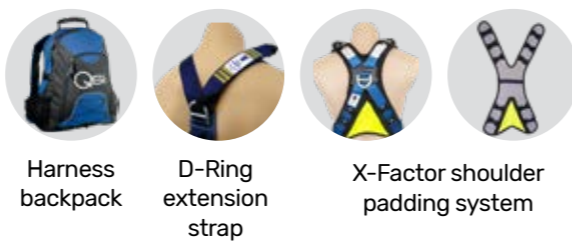

SBE5 RIG



SBE5KQRPRO is pictured with optional extension strap (confined space loops removed).



Full body self-conforming adjustable harness with dorsal and sternal D-Rings - SBE8

Features

Our SBE8 Full Body Harness sets the bar for comfort and flexibility with a new innovation from QSI: the Ring Junction. Shoulder, chest and side straps meet at rings just below the chest where they can each slide and rotate to conform to the user's body shape. The end result is a simple harness that fits more people more comfortably than ever before.

The harness includes dorsal and sternal attachment D-Rings for fall-arrest. High strength, easy adjustment webbing buckles are used on both legs and chest. Other features include easy-grip shoulder adjustment buckles and high strength stitch pattern.

The SBE8 is available in sizes 3XL and above for use in conjunction with a 150kg rated fall arrest block. See pg. 130 for more information.

Optional Extras:

- D-Ring Extension Strap
- X-Factor Shoulder Padding System
- AirTech Breathable Padding System (see pg. 129)
- Heavy Duty PVC Bags, Backpacks, etc (see pg. 156)
- Tool Lanyards and Pouches (see pg. 208)

Certified to: AS/NZS 1891.1:2007

Product Codes

SBE8	Full Body Self-Conforming Adjustable Harness
SBE8QR	Full Body Self-Conforming Adjustable Harness with Quick Release Buckles
SBE8QRPRO	Same specs as QR model above, plus X-Factor Shoulder Padding

Optional accessories

SMALL & 3XL+
sizes available on request

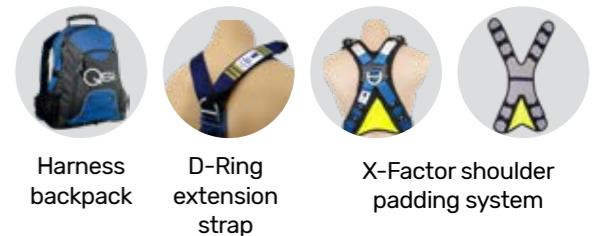

SBE8QRPRO is pictured with optional extension strap.

Full body cross link harness - SBE9 series



SBE9PRO is pictured.

**SBE9
SBE9PRO**



Features

The SBE9 is a new crosslink design featuring floating shoulder and leg straps. The harness includes two attachment points located on the centre front and centre back.

For general use, construction, mobile platforms and roofing.

Suitable for fall arrest from both front and rear 'D' rings.

The standard harness is a one-size-fits-all covering M - 2XL.

Larger 3XL+ are available for use in conjunction with a 150kg rated fall arrest block. See pg. 130 for more information.

Certified to: AS/NZS 1891.1:2007

Product Codes

SBE9	Full Body Cross Link Harness
SBE9PRO	Full Body Cross Link Harness, plus X-Factor Shoulder Padding

Optional accessories

SMALL & 3XL+
sizes available on request



Harness backpack

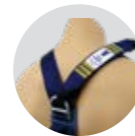

D-Ring extension strap

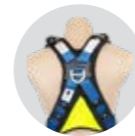

X-Factor shoulder padding system



Full body with padded waist belt, D-Rings and confined space loops - SBE7



SBE7



SMALL & 3XL+
sizes available on request

Features

The SBE7 has been developed in conjunction with the construction industry. The shoulder padding, single centre chest D-Ring and quick release buckle make for increased user comfort and support.

Large D-Rings provide lateral stability and a hands-free solution when used with Pole Straps. Confined space loops on the fully adjustable shoulder straps allow easy extraction from tight spaces.

The padded waist belt includes handy tool loops.

The SBE7 is available in sizes 3XL and above for use in conjunction with a 150kg rated fall arrest block. See pg. 130 for more information.

NOTE: SBE7 comes standard with X-Factor shoulder padding.

Certified to: AS/NZS 1891.1:2007

Product Codes

SBE7	Full Body Harness with Padded Waist Belt, D-Rings and Confined Space Loops
------	--



Pictured tools not included.

Full body multitask harness - SBEMT



SBEMT



General Use



Construction



Mobile Platform



Roofing



Rescue



Confined space



Tower



Rigging suspension



Work positioning



SMALL & 3XL+
sizes available
on request

Features

The SBEMT Multitask Harness is an innovative design allowing the user full adjustment on the chest, legs and position of the Dorsal D-Ring. The result is a harness that fits more users more comfortably.

A standard harness will fit from a medium to a 2XL sized worker. We believe the webbing-to-buckle adjustment relationship is critical to happy users, as well as the ease of putting on the harness. With this in mind we designed our Multitask Harness to be what the workforce is looking for.

In the event of a fall the durable Polyester webbing in our design evenly distributes the impact over the thighs, torso and buttocks. Polyester is known for being wear resistant and non-stretch when compared to other materials, so the harness does not stretch dangerously out of shape when subjected to a fall, reducing the risk of slipping out of the harness.

Our arrest products are designed to meet the high demands of the industry, and the high-quality fittings and easy adjustability of the SBEMT model ensures high user acceptance.

Our harnesses have been specifically designed to meet the AS/NZS 1891.1:2007 standard.

- Superior webbing to buckle relationship, effortlessly slides through the buckle for easy adjustment.
- Shoulder adjustment allows harness to fit people of different heights.
- Standard harness fitting is from M to XXL, accommodating a larger workforce.
- Easy no-tangle donning.
- The sternal point is particularly suitable for use with rope or cable grabs. It offers a comfortable position to work from.
- Ideally positioned sit-strap for extended comfort.
- Lateral D-Rings: For attachment with pole straps, to enable the worker to work comfortably, with both hands free.
- Padded Belt: Increases support and worker productivity.

Certified to: AS/NZS 1891.1:2007

Product Codes

SBEMT Full Body Multitask Harness



Premium full body harness range



High quality, easily adjustable aluminium chest buckle



Lightweight, high strength aluminium D-Rings



Colour-coded shoulder and back padding



Quick release aluminium leg & waist buckle

A range of colour options available on request. Lead times for manufacture may vary.



Supplied in our high quality colour scopic backpack

Premium full body harness - SBE2²



SBE2²



General Use



Construction



Mobile Platform



Roofing



SMALL & 3XL+ sizes available on request

Features

Our Premium Full Body Harness features two attachment webbing loops and a dorsal attachment D-Ring for fall-arrest. The sternal attachment points are particularly suitable for use with rope or cable grabs and offer a comfortable position to work from as well as for rescue.

High strength, easy adjustment webbing buckles are used on both legs and chest. Other features include easy-grip shoulder adjustment buckles, webbing fall arrest loops and high strength stitch pattern.

Certified to: AS/NZS 1891.1:2007

Product Codes

SBE22	Colour Scopic Full Body Harness
-------	---------------------------------

Premium full body harness with confined space loops - SBE3²



SBE3²



General Use



Construction



Mobile Platform



Confined Space



Roofing



SMALL & 3XL+ sizes available on request

Features

This harness takes all the great features of our SBE2² Full Body Harness and adds confined space loops to the shoulder straps to make it suited for workers in confined spaces. The loops can be used with a spreader bar during emergency retrieval situations to comfortably raise or lower the user.

Certified to: AS/NZS 1891.1:2007

Product Codes

SBE32	Premium Full Body Harness with Confined Space Loops
-------	---

Premium full body harness with padded waist belt, D-rings and confined space loops - SBE5²



SBE52

- General Use
- Construction
- Mobile Platform
- Roofing
- Work Positioning

SMALL & 3XL+
sizes available on request

Features

The SBE5² combines all the great features of the SBE3² and SBE4, and adds a full padded waist belt for increased user comfort and support. Large D-Rings provide lateral stability and a hands-free solution using Work Positioning Lanyards, while confined space loops on the fully adjustable shoulder straps allow easy extraction from tight spaces.

Certified to: AS/NZS 1891.1:2007

Product Codes

SBE52	Premium Full Body Harness with Padded Waist Belt, D-Rings and Confined Space Loops
--------------	--

Premium full body multitask harness - SBEMT²



SBEMT²

- General Use
- Construction
- Mobile Platform
- Confined Space
- Roofing
- Rescue
- Work Positioning
- Tower
- Rigging Suspension

SMALL & 3XL+
sizes available on request

Features

Takes the same great design of the standard SBEMT and adds more comfort features with Quick Release buckles and Easy Waist Adjustable Buckle.

Certified to: AS/NZS 1891.1:2007

Product Codes

SBEMT2	Premium Full Body Multitask Harness
---------------	-------------------------------------



Can be used in conjunction with the Easy Seat.



Evo standard rig restraint harness - SBEEVORIG



SBEEVOT

- General Use
- Rescue
- Confined Space
- Construction
- Work Positioning
- Roofing
- Mobile Platform
- Tower
- Rigging Suspension

SMALL & 3XL+
sizes available on request

Features

The QSI Evo Harness is an innovative design allowing the user full adjustment of the chest, legs and position of the Dorsal D-Ring. As a result, the QSI Evo Harness range fits more users, more comfortably.

The standard harness will fit from a medium to a 2XL worker. QSI believe that webbing to adjustment relationship is critical to happy users, as well as the ease of putting on the harness. With this in mind we designed the Evo to be what the workforce is looking for.

In the event of a fall, the durable polyester webbing distributes the impact evenly over the thighs, torso and buttock region. Polyester is known for being wear resistant and non-stretch when compared to other materials, so the harness does not stretch dangerously out of shape when subjected to a fall, therefore the wearer does not risk slipping out of the harness.

Certified to: AS/NZS 1891.1:2007

Product Codes

SBEEVOT	Evo Tower Harness
SBEEVOFULL	Evo Full Body Harness (not pictured)
SBEEVORIG	Evo Standard Rig Restraint Harness (not pictured)

Evo arborists sit harness - SBEEVOARB



Designed by arborists for arborists.

SBEEVOARB



SMALL & 3XL+
sizes available on request

Features

The SBEEVOARB was designed by local arborists who needed a working harness that combined safety and flexibility like never before.

The extra-wide, semi-rigid waistbelt offers exceptional support. The harness is easy to don with FAST buckles on the waistbelt and leg loops.

An attachment bridge provides lateral mobility. This is attached to the waistbelt and to the leg loops by a locking buckle to increase hang time, in order to distribute the pressure evenly between the waistbelt and leg loops.

The two lateral attachment points transfer the weight evenly around the waistbelt for comfort while leaning back in the belt (when feet are supported). Eight adjustment points means the user can customize the fit more easily for a greater level of comfort and a longer use time.

Other features include:

- Three equipment loops with protective sheaths
- One ring for attaching a hand saw

Note: pictured rope, carabiner and rope grab not included

Product Codes

SBEEVOARB	Evo Arborists Sit Harness
------------------	---------------------------

Kevlar full body harness with confined space loops - SBE3NZKEV

SBE3NZKEV Features



SMALL & 3XL+
sizes available on request

This harness is made with Kevlar webbing and Kevlar thread to help keep welding and grinding sparks damage to a minimum.

Taking all the great features of the SBE3K Full Body Harness, with confined space loops on the shoulder straps to make it suitable for workers in confined space environments.

The shoulder loops can be used with a spreader bar during emergency retrieval situations to comfortably raise or lower the user.

Certified to: AS/NZS 1891.1:2007

Product Codes

SBEMT2	Premium Full Body Multitask Harness
--------	-------------------------------------



Flame retardant harness vest

Features

One of the biggest challenges facing construction companies is keeping welding and grinding sparks off the harness webbing. High tech Kevlar/Nomex harnesses are available but the cost is exorbitant.

QSI brings you the solution: The FR Harness Vest.

The FR Harness Vest is comprised of a 100% FR treated cotton vest with an integrated SBE2KQR full body harness. The vest provides thermal and burn protection to the harness webbing and the wearer, and features several flaps that allow easy access to the dorsal D-Ring and chest loops.

The FR Harness Vest is also available to order with many other harnesses in our range. Please contact us for more information.

The vest detaches from the harness, allowing either item to be replaced as required, and makes the harness available for inspection. This combination makes donning the harness easy.

Other features include:

- Self extinguishing fabric, will not catch alight.
- Protection against arcing.
- Adjustable sides for a secure fit.
- Lightweight and easy to wear.
- Handy chest pockets.

Note: Although the FR Harness Vest will not catch alight, large pieces of welding splatter or similar may penetrate the garment if left in contact.

Harness certified to: AS/NZS 1891.1:2007

Product Codes

FRHARNVEST	FR Harness Vest + SBE2KQR
FRHARNVEST01	FR Harness Vest Only



6mm Steel cable shock absorbing lanyard

Features

This lanyard features 6mm steel cable and a flame resistant sleeve over the webbing shock absorbing block. It is ideal for use when welding or grinding, where sparks or fire are a risk.

Certified to: AS/NZS 1891.1:2007

Product Codes

S041	2m Long - 6mm Cable Shock Absorbing Lanyard, Triple Locking Carabiner and Scaffolding Hook
------	--



Y-Tech™ Pro Tower Harness - YTECH-PRO



Features

The Y-Tech™ Pro Tower Harness has been developed following extensive consultation with our power utility end-users, giving them the features they desire most.

This premium harness has been designed to eliminate restriction on the shoulders, allowing total upper body movement.

Features include:

- Alloy components.
- Webbing dorsal ring.
- Pole strap attachment points.
- Glove and barriered from waist up.
- Free fall arrest attachment points. Chest straps raise or lower seat for comfort.
- Easy donning & doffing due to the quick release buckles and specialised design.
- Y-shaped back reduces the pressure on the upper torso allowing more freedom to reach out.
- Bright colours with reflective stitching built into the webbing allows for higher visibility under work lights.
- Reduced obstructions on the top of the harness help prevent entanglement while working through power lines.
- Flexible, water-resistant padding on waist and seat allows continued comfort for long periods of time, even while sitting in a vehicle.
- Rear buckle to allow for adjustment of the back webbing ring (this allows for users of different heights to be comfortable).
- Adjustable seat that can be adjusted to allow for comfortable seating during pole strap work. This unique feature allows the user to customise the seat to their work style.

Certified to: AS/NZS 1891.1:2007

Design Registration Number: 201815478

Product Codes

YTECH-PRO Premium Y-Tech tower harness

Harness includes



Supplied in our high quality Colour Scopic Backpack



Quick release aluminium leg and waist buckle

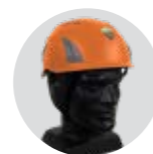

See pg 189 for details of QSi's plugged safety helmet

SMALL & 3XL+
sizes available on request

Live Wire Pro Cross Over Tower Harness - SBELW-PRO



Features

The Live Wire Pro gives you a new level of comfort, flexibility and safety.

Combining elements of our SBE9 Crosslink Harness, SBETH Tower Harness and Arborists Harness, the Live Wire Pro is a premium harness you can comfortably work in for hours.

Features include:

- Webbing dorsal ring.
- Front and rear fall arrest D-rings.
- Fully padded lower back and seat for extra comfort.
- Fully insulated dielectric upper body hardware.
- Alloy components - lighter and less prone to corrosion.
- Crosslink design to take stress off the shoulders and provide a greater range of movement.
- Pole strap attachment points that guide the forces through the buttocks instead of the back.
- The unique design helps eliminate suspension trauma when the user is suspended from the front D-ring or side pole strap rings.
- The leg fastening straps do not pass through the groin area which helps relieve pressure and circulation problems in fall situations.
- The adjustable seat and wide back padding provides comfortable support when working under work-position tension for long periods of time.

Certified to: AS/NZS 1891.1:2007

Product Codes

SBELW-PRO Live Wire Pro harness

Harness includes



Supplied in our high quality Colour Scopic Backpack



Quick release aluminium leg and waist buckle

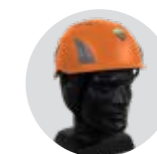

See pg 189 for details of QSi's plugged safety helmet

SMALL & 3XL+
sizes available on request

Full body tower harness - SBETH²



SBETH²

- General Use
- Construction
- Mobile Platform
- Electrical
- Work Positioning
- Tower

Features

The Tower Harness takes height safety to a whole new level. Specially designed for high voltage electrical situations, the harness is gloved from the waist up to make it suitable for linesman work.

It features insulated chest buckles and polyester webbing Dorsal D-Ring to reduce the risk of electric shock, as well as a padded waist belt and lateral D-Rings for hands free stability.

The built-in Support Seat gives added comfort and enables the user to work from the harness for extended periods of time.

Our colour options upgrade makes an already excellent harness even better.

Certified to: AS/NZS 1891.1:2007

Product Codes

SBETH² Full body tower harness

Harness includes



Supplied in our high quality Colour Scopic Backpack



Quick release aluminium leg and waist buckle



See pg 189 for details of QSi's plugged safety helmet

SMALL & 3XL+
sizes available on request

Dielectric full body harness - SBE2KDE



SBE2KDE

- General Use
- Construction
- Mobile Platform
- Electrical

Features

Designed for line workers operating from cherry picker buckets, The Dielectric Harness is based on our standard SBE2K full body harness with the added safety of fully insulated steel hardware across the entire harness. The buckles, adjusters and dorsal D-ring are all coated in a strong, non-conductive plastic for total peace of mind when working near live wires.

Product Codes

SBE2KDE Dielectric full body tower harness

SMALL & 3XL+
sizes available on request

Glove and barrier harness - SBE3GB



SBE3GB

- General Use
- Construction
- Mobile Platform
- Electrical
- Confined Space

Features

Several of our standard harnesses are available in Glove and Barrier versions with insulated chest buckles, suitable for line work.

Certified to: AS/NZS 1891.1:2007

Product Codes

SBE3GB Full Body Glove and Barrier Harness with Confined Space Loops

SMALL & 3XL+
sizes available on request

Glove and barrier harness - SBE5GB



SBE5GB

- General Use
- Construction
- Mobile Platform
- Electrical
- Confined Space
- Work Positioning

Features

Several of our standard harnesses are available in Glove and Barrier versions with insulated chest buckles, suitable for line work.

Certified to: AS/NZS 1891.1:2007

Product Codes

SBE5GB Full Body Glove and Barrier Harness with Padded Waist Belt, D-Rings and Confined Space Loops

SMALL & 3XL+
sizes available on request

Suspension trauma strap

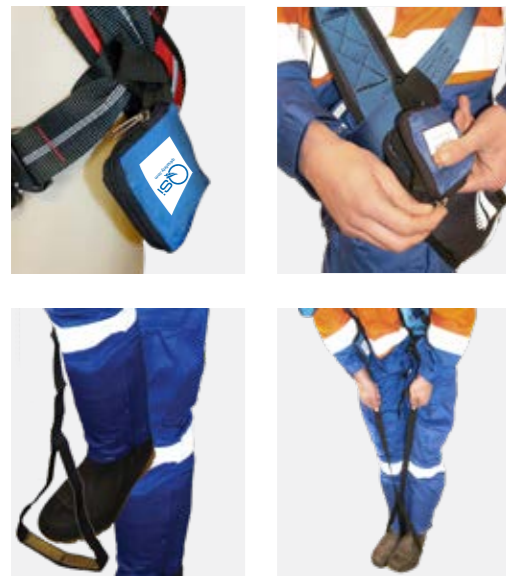

Features

The Suspension Trauma Strap is designed to prevent suspension trauma while a worker is awaiting rescue.

What is Suspension Trauma?

This condition can occur when a person remains suspended at height (after a fall) for even short periods of time.

Suspension in a harness may cause blood to pool in the veins of the legs which can result in unconsciousness; if not rescued promptly, serious injury or death may occur.

Product Codes

SBESTS	Suspension trauma strap
--------	-------------------------

AirTech™ breathable padding system



Stitching Pattern allows airflow around and through the Foam Padding



- AirMesh Polyester Outer Skin
- Open-Cell Foam Padding
- AirMesh Polyester Lining

Features

Our new padding material is perfectly suited to hot environments, with breathable foam and fabric to keep you cooler for longer.

Available as an option in place of standard padding on all our padded harnesses including the SBE5, SBE7, SBEMT, SBETH and the entire ColourScopic range.

X-Factor shoulder padding system



Product Codes

SBEXFP	X-Factor Shoulder Padding
--------	---------------------------

Add your branding to QSi height safety gear



Block Label

Your logo printed and sealed under the heat shrink plastic of your shock absorbing block.

We understand the importance of brand recognition but unfortunately most height safety gear tends to cover up any branding you might have on your clothing. We've found the solution.

As a local manufacturer we have the unique ability to offer you custom branded harnesses and lanyards. These additions have been tested rigorously to ensure the equipment continues to comply with the appropriate safety standards, giving you brand recognition without compromising the safety of your team.

Both monochrome and full colour options are available.

Custom Branding Codes

SETUP	Artwork Setup Fee
CUSTBRAND1	Harness Cross Piece
CUSTBRAND2	Harness Label Wallet
CUSTBRAND3	Branding Patch
CUSTBRAND4	Block Label



Harness Cross Piece

A strong Cordura panel attached to both rear straps of the harness, screen printed with your logo.



Harness Label Wallet

Our standard Cordura label wallet printed with your logo.



Branding Patch

A simple length of Cordura printed with your logo and sewn onto the webbing of your harness or lanyard.

D Ring Extension Strap (does not include maillon)



Product Codes

SBEXS	D Ring Extension Strap (does not include maillon)
-------	---

Triple action talon hooks

Our triple-action Talon Hook™ is the latest evolution in snap hooks. This product requires three separate actions to open the gate, greatly reducing the potential for accidental release. Much like the eagle depends on its talons for survival, you can depend on the Talon Hook™ for a new level of safety while working at height.

The talon shape and wide gate opening of this hook means it clips on to a wider variety of attachment points, while still being compact and lightweight.

Why Talon Hooks™?

- Robust Steel Construction
- Secure Triple Action Mechanism
- Versatile Hook Design

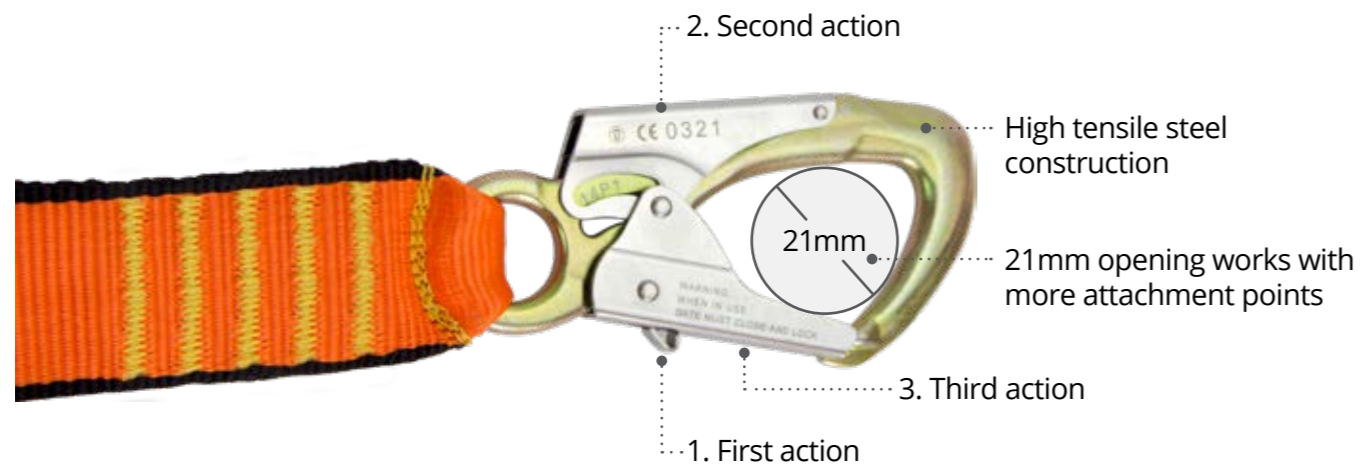

Pole straps

We develop and produce our own webbing pole straps using the highest quality polyester webbing and synthetic stitching. Our unique stitching pattern prevents the hook folding back on itself, maintaining the strength of the webbing without the need for a plastic keeper. Available in custom lengths over 2.5m.

Pole strap with talon hooks™



Features

Designed to be attached to user's belt at the waist and slung around a pole for work positioning. Talon Hooks™ at both ends with an adjustable stainless steel buckle.

Certified to: AS/NZS 1891.1:2007

Product Codes

SBL11STAL	Pole Strap with Talon Hooks™ - 2.5m
SBL11S2TAL	Pole Strap with Talon Hooks™ - 2.2m
SBL11S3TAL	Pole Strap with Talon Hooks™ - 1.8m
SBL11S4TAL	Pole Strap with Talon Hooks™ - 1.5m

Pole strap



Features

Designed to be attached to user's belt at the waist and slung around a pole for work positioning. Double Action Hooks at both ends with an adjustable stainless steel buckle.

Certified to: AS/NZS 1891.1:2007

Product Codes

SBL11S	Pole Strap - 2.5m
SBL11S2	Pole Strap - 2.2m
SBL11S3	Pole Strap - 1.8m
SBL11S4	Pole Strap - 1.5m

Pole strap with swivel hook



Features

Designed to be attached to user's belt at the waist and slung around a pole for work positioning. Carabiner at one end and Swivel Hook at the other end.

Certified to: AS/NZS 1891.1:2007

Product Codes

SBL14AS	Pole Strap with Swivel Hook - 2.5m
SBL14AS2	Pole Strap with Swivel Hook - 1.8m
SBL14AS3	Pole Strap with Swivel Hook - 1.5m

Kernmantle rope pole strap with rope grab



Features

The combination of AS/NZS approved Kernmantle rope and rope grab allows the user to quickly adjust the length of the strap on the fly. Available with either a Double Action Hook or Swivel Hook.

Certified to: AS/NZS 1891.1:2007

Product Codes

SBL12A	Kernmantle Pole Strap with Rope Grab and DA Hook - 2.5m
SBL12A2	Kernmantle Pole Strap with Rope Grab and DA Hook - 1.8m
SBL12A3	Kernmantle Pole Strap with Rope Grab and DA Hook - 1.5m
SBL12AS	Kernmantle Pole Strap with Rope Grab and Swivel Hook - 2.5m
SBL12AS2	Kernmantle Pole Strap with Rope Grab and Swivel Hook - 1.8m
SBL12AS3	Kernmantle Pole Strap with Rope Grab and Swivel Hook - 1.5m

Kernmantle rope pole strap with SIR adjuster



Features

This premium pole strap allows the user to set the length quickly and easily with the SIR adjuster.

Certified to: AS/NZS 1891.1:2007

Product Codes

SBL12ASIR	Adjustable 12mm Rope Pole Strap with SIR adjuster & MH009 Hook - 2.5m
-----------	---

Triple locking carabiner lanyards

Triple Locking Carabiners combine a higher level of safety with a fast, easy to use action.

Unlike screw-gate carabiners that must be manually locked and unlocked, the triple locking carabiner automatically locks in place as the gate closes, so you never have to worry about whether you or your colleague remembered to do it.

It also requires three distinct movements to open, helping prevent accidental release while still being easy to operate with a single hand.



Webbing - Fixed-length

Note: to comply with AS/NZS 1891.1:2007, lanyards can be no more than 2m in length. If you intend to use your lanyard with a D-Ring Extension Strap, be sure to choose the 1.5m lanyard.

Single leg lanyard



Features

Shock absorbing lanyard with triple locking carabiner and double action hook. Available in 1.5m and 2m lengths.

Certified to: AS/NZS 1891.1:2007

Product Codes

S001C	1.5m Single Leg - 1 Triple Action Carabiner and 1 double action hook
S002C	2m Single Leg - Triple Action Carabiner and 1 double action hook

NOTE - Our standard range of lanyards are suitable for up to 120kg user limit. For user weights over 120kg, please refer to page 146 onwards.

Single leg lanyard with scaffolding hook



Features

Shock absorbing lanyard with scaffolding hook and triple locking carabiner. Available in 1.5m and 2m lengths.

Certified to: AS/NZS 1891.1:2007

Product Codes

S003C	1.5m Single Leg - 1 Triple Action Carabiner and 1 scaffolding hook
S004C	2m Single Leg - 1 Triple Action Carabiner and 1 scaffolding hook

Double leg lanyard with twin scaffolding hooks



Features

Double leg shock absorbing lanyard with twin scaffolding hooks and triple locking carabiner. Available in 1.5m and 2m lengths.

Certified to: AS/NZS 1891.1:2007

Product Codes

S007C	1.5m Double Leg - 1 Triple Locking Carabiner and twin scaffolding hooks
S008C	2m Double Leg - 1 Triple Locking Carabiner and twin scaffolding hooks

Double leg 25mm shock absorbing lanyards



Features

These lanyards feature 25mm webbing with carabiner and twin scaffolding hooks and come in three lengths.

Certified to: AS/NZS 1891.1:2007

Product Codes

S047	1.5m Double Leg 25mm - 1 Triple Locking Carabiner and twin scaffolding hooks
S048	1.75m Double Leg 25mm - 1 Triple Locking Carabiner and twin scaffolding hooks
S050	2m Double Leg 25mm - 1 Triple Locking Carabiner and twin scaffolding hooks

1m Ladder climbing lanyard



Features

Short, double leg shock absorbing 25mm webbing lanyard with triple locking carabiner and twin scaffold hooks. Designed to provide fall protection while working on ladders.

Note: ensure your ladder is of sufficient strength to take your weight in a fall and is securely attached to a permanent structure.

Certified to: AS/NZS 1891.1:2007

Product Codes

S075C	1m Ladder Climbing Lanyard
-------	----------------------------

Webbing - Adjustable

Note: to comply with AS/NZS 1891.1:2007, lanyards can be no more than 2m in length. When using an adjustable lanyard with a D-Ring Extension Strap, ensure the combined length of strap and lanyard never exceeds 2m.

Adjustable single leg lanyard



Features

Adjustable shock absorbing lanyard with triple locking carabiner and double action hook. Available in 2m length.

Certified to: AS/NZS 1891.1:2007

Product Codes

S014C	2m Adjustable Single Leg - 1 Triple Action Carabiner and 1 Double Action Snap Hook
-------	--

Adjustable double leg lanyard



Features

Adjustable double leg shock absorbing lanyard with twin double action snap hooks and triple locking carabiner. Available in 2m length.

Certified to: AS/NZS 1891.1:2007

Product Codes

S015C	2m Adjustable Double Leg - Triple Locking Carabiner and Twin Double Action Snap Hooks
-------	---

Adjustable double leg lanyard with twin scaffolding hooks



Features

Adjustable double leg shock absorbing lanyard with twin scaffolding hooks and triple locking carabiner. Available in 2m length.

Certified to: AS/NZS 1891.1:2007

Product Codes

S016C	2m Adjustable Double Leg - 1 Triple Action Carabiner and Twin Scaffolding Hooks
-------	---

Adjustable single leg lanyard with scaffolding hook



Features

Adjustable shock absorbing lanyard with scaffolding hook and triple locking carabiner. Available in 2m length.

Certified to: AS/NZS 1891.1:2007

Product Codes

S017C	2m Adjustable Single Leg Lanyard w/ Carabiner & Scaff Hook
-------	--

Kernmantle rope shock absorbing lanyards

Our kernmantle rope lanyards use high quality, static, 11mm AS/NZS approved rope. Precision sewn ends ensure the highest user safety.

Note: to comply with AS/NZS 1891.1:2007, lanyards can be no more than 2m in length. When using an adjustable lanyard with a D-Ring Extension Strap, ensure that the combined length of strap and lanyard never exceeds 2m.

Kernmantle single leg lanyard with scaffolding hooks - non-adjustable



Features

Kernmantle rope shock absorbing lanyard with scaffolding hook and triple locking carabiner. Available in 2m length.

Certified to: AS/NZS 1891.1:2007

Product Codes

S025C	2m Kernmantle Single Leg - 1 Triple Locking Carabiner and 1 scaffolding hook
-------	--

Kernmantle double leg, double action and twin scaffolding hooks - non-adjustable



Features

Kernmantle rope double leg shock absorbing lanyard with twin scaffolding hooks and triple locking carabiner. Available in 2m length.

Certified to: AS/NZS 1891.1:2007

Product Codes

S027C	2m Kernmantle Double Leg - 1 Triple Locking Carabiner and twin scaffolding hooks
-------	--

Kernmantle adjustable single leg lanyard with triple locking carabiner and double action hook - adjustable



Features

Adjustable Kernmantle rope shock absorbing lanyard with double action hook and triple locking carabiner. Available in 2m length.

Certified to: AS/NZS 1891.1:2007

Product Codes

S069	Kernmantle Adjustable Single Leg Lanyard with Triple Locking Carabiner and Double Action Hook
------	---

Kernmantle adjustable single leg lanyard with triple locking carabiner and scaffolding hook - adjustable



Features

Adjustable Kernmantle rope shock absorbing lanyard with scaffolding hook and triple locking carabiner. Available in 2m length.

Certified to: AS/NZS 1891.1:2007

Product Codes

S069S	Kernmantle Adjustable Single Leg Lanyard with Triple Locking Carabiner and Scaffolding Hook
-------	---

Elasticated webbing shock absorbing lanyards

Our elasticated webbing shock absorbing lanyards provide a compact and flexible lanyard system that expands and contracts with the user's every move, reducing the chances of snagging.

Note: to comply with AS/NZS 1891.1:2007, only lanyards 1.5m or shorter can be used with a D-Ring Extension Strap.

Elasticated single leg, double action and scaffolding hooks



Features
Elasticated shock absorbing lanyard with scaffolding hook and triple locking carabiner. Available in 2m length.

Certified to: AS/NZS 1891.1:2007

Product Codes

S031C	2m Elasticated Single Leg - 1 Triple Locking Carabiner and 1 steel scaffolding hook
S039C	2m Elasticated Single Leg - 1 Triple Locking Carabiner and 1 aluminium scaffolding hook

Elasticated double leg lanyard with twin hooks



Features
Elasticated double leg shock absorbing lanyard with twin scaffolding or giant hooks and triple locking carabiner.

Two lengths available: 2m (with steel scaffolding or giant hooks) and 1.8m (with giant aluminium hooks).

Certified to: AS/NZS 1891.1:2007

Product Codes

S033C	2m Elasticated Double Leg - 1 triple locking carabiner and twin steel scaffolding hooks
S035C	2m Elasticated Double Leg - 1 triple locking carabiner and twin giant steel hooks
S040C	1.8m Elasticated Double Leg - 1 triple locking carabiner and twin giant alloy hooks

Hook opening comparison



Scaffolding Hook (Steel) 56mm, Scaffolding Hook (Alloy) 64mm, Giant Hook (Steel) 85mm, Giant Hook (Alloy) 110mm

Webbing shock absorbing lanyards

Our webbing shock absorbing lanyards are made from the highest quality polyester webbing with synthetic stitching. A tear-out section is employed to reduce the forces and limits the effects on a user in a fall below 6kN. These lanyards come standard with double action hooks but most models are also available with triple locking carabiners.

All of our Webbing Shock Absorbing Lanyards are AS/NZS 1891.1:2007 compliant.

Fixed-length

Note: to comply with AS/NZS 1891.1:2007, lanyards can be no more than 2m in length. If you intend to use your lanyard with a D-Ring Extension Strap, be sure to choose the 1.5m lanyard.

Single leg lanyard



Features
Shock absorbing lanyard with double action hooks. Available in 1.5m and 2m lengths. **Certified to:** AS/NZS 1891.1:2007

Product Codes

S001	1.5m Single Leg - 2 Double Action hooks
S002	2m Single Leg - 2 Double Action hooks

Single leg lanyard with scaffolding hook



Features
Shock absorbing lanyard with double action hooks. Available in 1.5m and 2m lengths. **Certified to:** AS/NZS 1891.1:2007

Product Codes

S003	1.5m Single Leg - 1 Double Action hook and 1 scaffolding hook
S004	2m Single Leg - 2 Double Action hook and 1 scaffolding hook

Double leg lanyard with 3 double action hooks



Features
Double leg shock absorbing lanyard with double action hooks. Available in 1.5m and 2m lengths. **Certified to:** AS/NZS 1891.1:2007

Product Codes

S005	1.5m Double Leg - 3 Double Action hooks
S006	2m Double Leg - 3 Double Action hooks

Double leg lanyard with twin scaffolding hooks



Features
Double leg shock absorbing lanyard with twin scaffolding hooks and double action hook. Available in 1.5m and 2m lengths. **Certified to:** AS/NZS 1891.1:2007

Product Codes

S007	1.5m Double Leg - 1 Double Action hook and twin scaffolding hooks
S008	2m Double Leg - 1 Double Action hook and twin scaffolding hooks

Adjustable

Note: to comply with AS/NZS 1891.1:2007, lanyards can be no more than 2m in length. When using an adjustable lanyard with a D-Ring Extension Strap, ensure the combined length of strap and lanyard never exceeds 2m

Adjustable single leg lanyard



Features

Adjustable Shock absorbing lanyard with double action hooks. Available in 2m length. **Certified to: AS/NZS 1891.1:2007**

Product Codes

S014 2m Adjustable Single Leg - 2 Double Action hooks

Adjustable double leg lanyard



Features

Adjustable double leg shock absorbing lanyard with double action hooks. Available in 2m length. **Certified to: AS/NZS 1891.1:2007**

Product Codes

S015 2m Adjustable Double Leg - 3 Double Action hooks

Adjustable double leg lanyard with twin scaffolding hooks



Features

Adjustable double leg shock absorbing lanyard with twin scaffolding hooks and double action hook. Available in 2m length. **Certified to: AS/NZS 1891.1:2007**

Product Codes

S016 2m Adjustable Double Leg - 1 Double Action hook and twin scaffolding hooks

Adjustable single leg lanyard with scaffolding hook



Features

Adjustable shock absorbing lanyard with scaffolding hook and double action hook. Available in 2m length. **Certified to: AS/NZS 1891.1:2007**

Product Codes

S017 2m Adjustable Single Leg - 1 Double Action hook and 1 scaffolding hook

Adjustable double leg lanyard with double action and twin giant hooks



Features

Adjustable double leg shock absorbing lanyard with a double action hook and a choice of either steel or aluminium giant hooks. Available in 2m length. **Certified to: AS/NZS 1891.1:2007**

Product Codes

S045 2m Adjustable Double Leg - 1 Double Action hook and twin giant hooks - steel

S046 2m Adjustable Double Leg - 1 Double Action hook and twin giant hooks - aluminium

Kernmantle rope shock absorbing lanyards

Our kernmantle rope lanyards use high quality, static, 11mm AS/NZS approved rope. Precision sewn ends ensure the highest user safety.

Note: to comply with AS/NZS 1891.1:2007, only lanyards 1.5m or shorter can be used with a D-Ring Extension Strap.

Kernmantle single leg, 2 double action hooks



Features

Kernmantle rope shock absorbing lanyard with 2 double action hooks. Available in 2m length. **Certified to: AS/NZS 1891.1:2007**

Product Codes

S024 2m Kernmantle Single Leg - 2 Double Action hooks

Kernmantle single leg lanyard with scaffolding hooks



Features

Kernmantle rope shock absorbing lanyard with scaffolding hook and double action hook. Available in 2m length.

Certified to: AS/NZS 1891.1:2007

Product Codes

S025 2m Kernmantle Single Leg - 1 Double Action hook and 1 scaffolding hook

Kernmantle double leg, 3 double action hooks



Features

Kernmantle rope double leg shock absorbing lanyard with double action hooks. Available in 2m length. **Certified to: AS/NZS 1891.1:2007**

Product Codes

S026 2m Kernmantle Double Leg - 3 Double Action hooks

Kernmantle double leg, double action and twin scaffolding hooks



Features

Kernmantle rope double leg shock absorbing lanyard with twin scaffolding hooks and double action hook. Available in 2m length.

Certified to: AS/NZS 1891.1:2007

Product Codes

S027 2m Kernmantle Double Leg - 1 Double Action hook and twin scaffolding hooks

Bucket Lanyards

These lanyards are designed specifically for cherry-picker and scissor-lift work, providing great security and peace of mind when working in a bucket or other mobile platform.

Note: to comply with AS/NZS 1891.1:2007, only lanyards 1.5m or shorter can be used with a D-Ring Extension Strap.

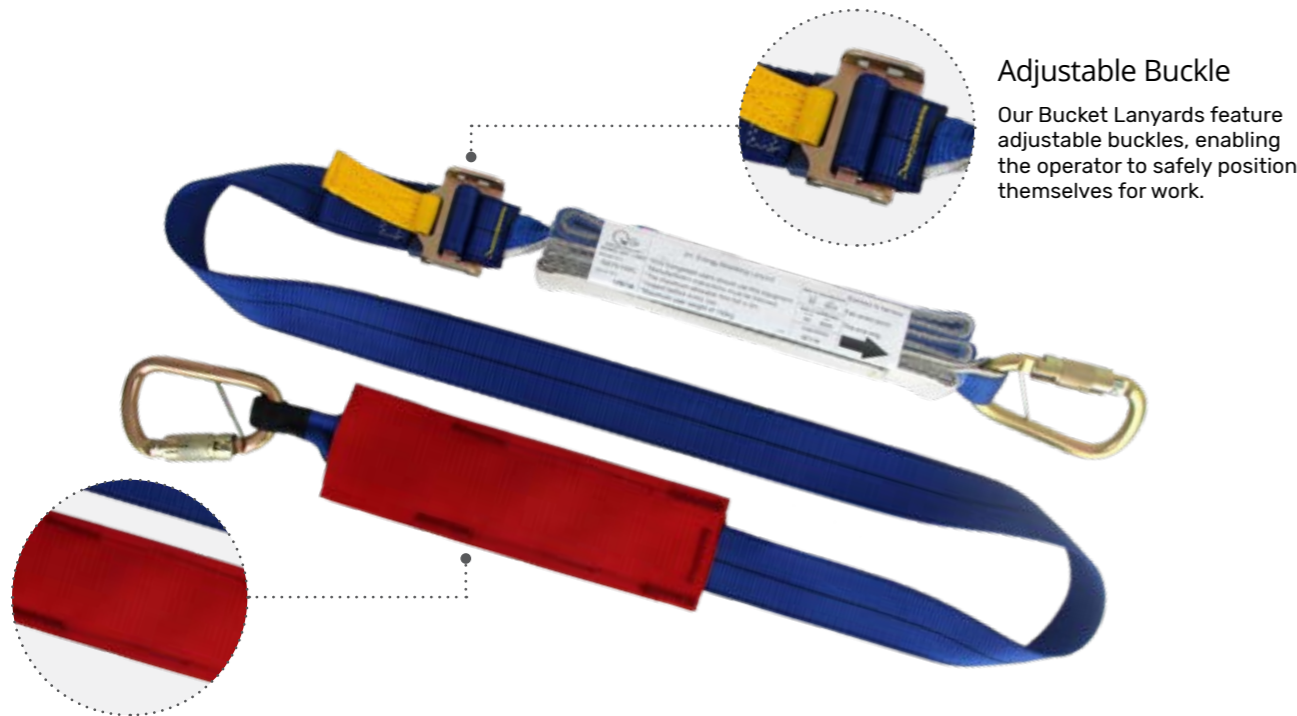

Adjustable Buckle
Our Bucket Lanyards feature adjustable buckles, enabling the operator to safely position themselves for work.

Wear Sheath
Our Bucket Lanyards come with an integrated wear sheath to prevent damage to the lanyard caused by contact with the bucket edge.

Adjustable 2m bucket lanyard



Features
Standard adjustable shock absorbing bucket lanyard with integrated wear sheath and twin triple locking carabiners.
Certified to: AS/NZS 1891.1:2007

Product Codes	
S076C	Adjustable 2m Bucket Lanyard

150kg adjustable 2m bucket lanyard



Features
The same great features as the standard lanyard but with heavy duty shock absorbing block for use by larger workers up to 150kg.
Certified to: AS/NZS 1891.1:2007

Product Codes	
S075150C	150kg Adjustable 2m Bucket Lanyard

Elastic webbing shock absorbing lanyards

Our elasticated webbing shock absorbing lanyards provide a compact and flexible lanyard system that expands and contracts with the user's every move, reducing the chances of snagging.

Note: to comply with AS/NZS 1891.1:2007, only lanyards 1.5m or shorter can be used with a D-Ring Extension Strap.

Elasticated single leg, 2 double action hooks



Features
Elasticated shock absorbing lanyard with 2 double action hooks. Available in 2m length. **Certified to: AS/NZS 1891.1:2007**

Product Codes	
S030	2m Elasticated Single Leg - 2 Double Action hooks

Elasticated single leg, double action and scaffolding or giant hooks



Features
Elasticated shock absorbing lanyard with scaffolding hook and double action hook. **Certified to: AS/NZS 1891.1:2007**

Product Codes	
S031	2m Elasticated Single Leg - 1 Double Action hook and 1 scaffolding hook
S031A	1.2m Elasticated Single Leg - 1 Double Action Hook and 1 aluminium scaffolding hook
S042	2m Elasticated Single Leg - 1 Double Action hook and 1 aluminium scaffolding hook
S039	1.8m Elasticated Single Leg - 1 Double Action hook and 1 giant aluminium hook

Elasticated double leg, 3 double action hooks



Features
Elasticated double leg shock absorbing lanyard with double action hooks. Available in 2m length. **Certified to: AS/NZS 1891.1:2007**

Product Codes	
S032	2m Elasticated Double Leg - 3 Double Action hooks

Elasticated double leg lanyard with twin scaffolding hooks



S033



S033A



S033-ANSI



S035



S040

Features

Elasticated double leg shock absorbing lanyard with twin scaffolding hooks and double action hook.
Two lengths available: 2m (with standard scaffolding hooks or aluminium rebar hooks) and 1.8m (with giant aluminium hooks).
Certified to: AS/NZS 1891.1:2007

Product Codes

S033	2m Elastic Double Leg Shock Lanyard w/ 1 D/A Hook & 2 Steel Scaff Hooks
S033A	2m Elastic Shock Lanyard Dbl Leg -1 D/A Hook & 2 Alloy Scaff Hooks
S033-ANSI	2m Elastic Double Leg Shock Lanyard w/ 1 D/A Hook + 2 x MH011. 16 kN gate strength
S035	2m Double Leg Elastic Shock Lanyard w/ 1 D/A & 2 Giant Steel Scaff Hooks
S040	1.8m Twin Leg Shock Lanyard w/ 1 D/A Hook & 2 Giant Aluminium Scaffhook

Hook opening comparison



- MH011** Aluminium Rebar Hook
- MH004** Steel scaffolding Hook
- MH007** Alloy Scaffolding Hook
- MH005** Giant Steel Double Action Hook
- MH2084A** Giant Aluminium Scaffold Hook - 23kN

Product Codes

MH011	Aluminium Rebar Hook
MH004	Scaffold Hook - Double Action - Steel
MH007	Scaffold Hook - Double Action - Alloy
MH005	Giant Steel Double Action Hook
MH2084A	Giant Aluminium Scaffold Hook - 23kN



It's not about the harness, it's all about the block

When it comes to ensuring your safety in fall-risk situations, it is crucial that the Energy Absorbing Block attached to the harness is rated to your weight. In the same way that trucks require stronger brakes than cars, heavier people need stronger blocks to absorb the energy of their falls. Although our harnesses can hold many times the weight of an average person, the energy generated in a fall varies greatly depending on the weight of the person, so choose the block that's right for you.

Use this chart to determine which block is suitable for you:

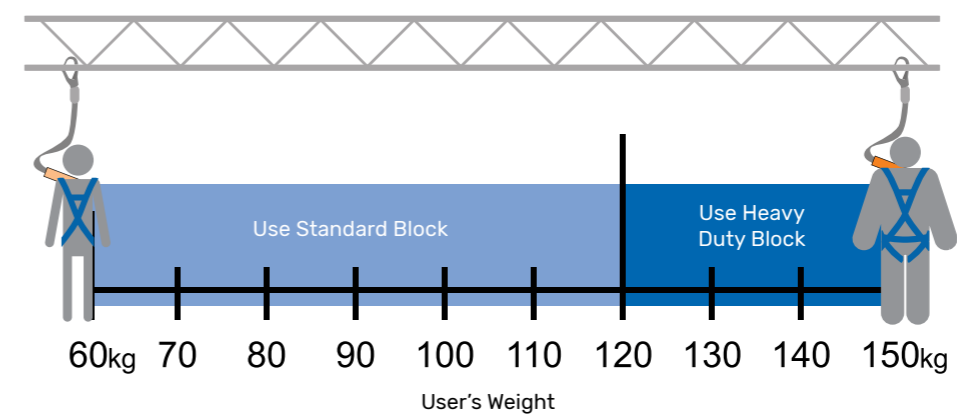

Energy absorbing blocks

Easy to add to your own safety system, these are the same top quality energy absorbing blocks we use in all our shock absorbing lanyards. Also available with carabiners.

Please note: your choice of block is dependent on the weight of the user. Please see overleaf for more information.

Mini energy absorbing block



Features

A compact block for when space is tight. Rated for users up to 120kg. Blocks - Energy Absorbing.

Product Codes

S009KMINI	Mini Energy Absorbing Block
S009KCMINI	Mini Energy Absorbing Block with Carabiners

Energy absorbing block



Features

Rated for users up to 120kg.

Product Codes

S009K	Energy Absorbing Block
S009KC	Energy Absorbing Block with Carabiners

Customisable energy absorbing block



Features

When our standard blocks don't meet your requirements, you can choose from the following custom options:

- A variety of webbing colours
 - Your logo printed on the label (see page 130.)
 - Attachment hardware including double action and scaffold hooks.
- Rated for users up to 120kg.

Product Codes

S009	Energy Absorbing Block
S009C	Energy Absorbing Block with Carabiners

Energy absorbing block cover



Features

This detachable cover is made of hard-wearing Cordura fabric and is designed to protect energy absorbing blocks from dirt & abrasive surfaces. When used correctly, the loops of the block protrude from each end so it is still easy to attach to your lanyard. The cover is held in place by strong Velcro.

Product Codes

HS03	Energy Absorbing Block Cover
------	------------------------------

Fixed-length Lanyards

Note: to comply with AS/NZS 1891.1:2007, lanyards can be no more than 2m in length. If you intend to use your lanyard with a D-Ring Extension Strap, be sure to choose the 1.5m lanyard.

- Tested to AS/NZS 1891.1:2007 at 100kg.
- Additional test conducted at 150kg.
- Total deployment may be achieved at fall factor 2 and a mass of 150kg.

Heavy duty single leg lanyard



Features

Heavy duty shock absorbing lanyard with 150kg rated Fall Arrest Block. Available in 1.5m and 2m lengths.

Certified to: AS/NZS 1891.1:2007

Product Codes

S001-150	1.5m Heavy Duty Single Leg Lanyard
S002-150	2m Heavy Duty Single Leg Lanyard

Heavy duty single leg lanyard with scaffolding hook



Features

Heavy duty shock absorbing lanyard with 150kg rated Fall Arrest Block, scaffolding hook. Available in 1.5m and 2m lengths.

Certified to: AS/NZS 1891.1:2007

Product Codes

S003-150	1.5m Heavy Duty Single Leg Lanyard with Scaffolding Hook
S004-150	2m Heavy Duty Single Leg Lanyard with Scaffolding Hook

Heavy duty double leg lanyard with double action hooks



Features

Heavy Duty double leg shock absorbing lanyard with two double action hooks, triple locking carabiner and 150kg rated Fall Arrest Block. Available in 2m length. **Certified to: AS/NZS 1891.1:2007**

Product Codes

S006-150	2m Heavy Duty Double Leg Lanyard with Twin Double Action Hooks
----------	--

Heavy duty double leg lanyard with twin scaffolding hooks



Features

Heavy Duty double leg shock absorbing lanyard with two scaffolding hooks, triple locking carabiner and 150kg rated Fall Arrest Block. Available in 2m length.

Certified to: AS/NZS 1891.1:2007

Product Codes

S008-150	2m Heavy Duty Double Leg Lanyard with Twin Scaffolding Hooks
----------	--

Adjustable Lanyards

Note: to comply with AS/NZS 1891.1:2007, lanyards can be no more than 2m in length. When using an adjustable lanyard with a D-Ring Extension Strap, ensure the combined length of strap and lanyard never exceeds 2m.

Heavy duty adjustable single leg lanyard



Features

Adjustable Heavy duty shock absorbing lanyard with double action hook, triple locking carabiner and 150kg rated Fall Arrest Block. Available in 2m length. **Certified to: AS/NZS 1891.1:2007**

Product Codes

S014-150 Heavy Duty Adjustable Single Leg Lanyard

Heavy duty adjustable single leg lanyard with scaffolding hook



Features

Adjustable Heavy duty shock absorbing lanyard with scaffolding hook, triple locking carabiner and 150kg rated Fall Arrest Block. Available in 2m length. **Certified to: AS/NZS 1891.1:2007**

Product Codes

S017-150 Heavy Duty Adjustable Single Leg Lanyard with Scaffolding Hook

Heavy duty adjustable double leg lanyard with double action hooks



Features

Heavy Duty Adjustable double leg shock absorbing lanyard with two double action hooks, triple locking carabiner and 150kg rated Fall Arrest Block. Available in 2m length. **Certified to: AS/NZS 1891.1:2007**

Product Codes

S015-150 Heavy Duty Adjustable Double Leg Lanyard with Twin Double Action Hooks

Heavy duty adjustable double leg lanyard with twin scaffolding hooks



Features

Heavy Duty Adjustable double leg shock absorbing lanyard with two scaffolding hooks, triple locking carabiner and 150kg rated Fall Arrest Block. Available in 2m length. **Certified to: AS/NZS 1891.1:2007**

Product Codes

S016-150 Heavy Duty Adjustable Double Leg Lanyard with Twin Scaffolding Hooks

Heavy duty adjustable double leg lanyard with double rebar hooks



Features

Heavy Duty Adjustable double leg shock absorbing lanyard with two aluminium rebar hooks and a 150kg rated Fall Arrest Block. Available in 2m length.

Certified to: AS/NZS 1891.1:2007

Product Codes

S033C-150 150kg - 2m Elastic Twin Leg - 1 Triple Lock Carabiner and Twin MH011

Heavy duty 170kg single leg lanyard



Features

Heavy Duty Adjustable single leg shock absorbing lanyard with two triple locking carabiners and a 170kg rated Fall Arrest Block. Available in 1.7m length.

Certified to: AS/NZS 1891.1:2007

Product Codes

S001-170 170kg 1.7m Single Leg lanyard W/- 2x MC004

Retractable Lanyards

We have a range of retractable lanyards with either internal braking mechanisms or shock absorbing blocks, using either webbing or steel cable.
All retractable lanyards conform to EN 360.

The AS/NZS 1891.3 standard stipulates any material supplied from overseas that complies with EN 360, EN 353-2 and EN 353-1 is acceptable for use in Australia and New Zealand.
(EN 360: Retractable Type Fall Arresters; EN 352-2: Guided type fall arresters – Flexible Anchorage Line; EN 353-1: Guided Type Fall Arresters – Rigid Anchorage Line and Rails).

2m webbing retractable lanyard



Features

This light-weight 2m Webbing Retractable unit has an internal braking system to reduce the fall forces.

- Fully serviceable at the QSI facility.

Certified to: EN 360:2002

Product Codes

SRLWB02	2m Retractable Lanyard
---------	------------------------

2.5m retractable lanyards



Features

This retractable webbing lanyard extends to 2.5m and has a shock absorbing block which will deploy in the event of a fall, limiting forces to below 6kN.

The lanyard has been manufactured with triple locking carabiners at both ends, giving a far superior level of safety than what screw-gate carabiners offer.

Available with swivel attachment at anchorage end, with fall indicator.

- Retractable Webbing 47mm wide.
- Maximum length: 2.5m
- Integrated energy absorbing block.
- Steel triple locking carabiners at anchorage and attachment ends.

Certified to: EN 360:2002

Product Codes

SRL2002	2.5m Retractable Lanyard
SRL2002SW	2.5m Retractable Lanyard with Swivel

2m micron block retractable lanyard

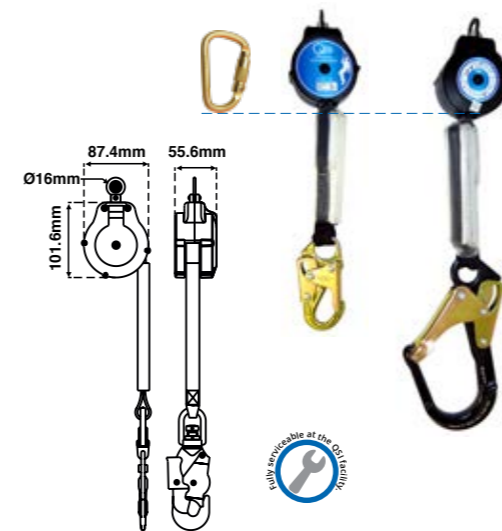

SCALE DIAGRAM SHOWING RELATIVE SIZE OF THE 2M MICRON BLOCK COMPARED TO A TRIPLE LOCKING CARABINER.



Servicing

Many of our retractable lanyards and cable blocks are serviceable, meaning they can be disassembled by an expert following a fall, checked for damage and made usable again.

All retractable lanyards must be inspected on an annual basis according to the AS/NZS 1891.1:2007 standard. When necessary, they can be inspected by QSI's technical department.

Features

The Micron Block is a compact, lightweight retractable lanyard with integrated shock absorbing block. At only 800g, it's very easy to carry.

To give you an idea of how small it really is, we've included an approximate scale image of our triple locking carabiner.

- Retractable 21mm width webbing.
- Maximum length: 2m
- Comes with your choice of 16kN gate steel snap hook or 16kN gate aluminium scaffold hook.
- MBL: 15kN
- Weight: 0.8kg
- Fully serviceable at the QSI facility.

Certified to: EN 360:2002

NOTE - All microns work in sharp-edge and horizontal usage.

Product Codes

MIC02	2m Micron Block Retractable Lanyard with Snap Hook
MIC02SCAFF	2m Micron Block Retractable Lanyard with Scaffold Hook
MIC03.5	3.5m Micron Block Retractable Lanyard with Snap Hook
HS169	Twin SRL Connector
HS170(Y)	Single SRL Connector



HS170(Y)



HS169

3.5m retractable lanyards



Features

The new 3.5m unit gives extra reach and has an internal braking system to reduce the fall forces.

- Webbing and Stainless Steel Cable versions available.
- Fully serviceable at the QSI facility.

Certified to: EN 360:2002

Product Codes

SRLSS3.5	3.5m Retractable Lanyard - Stainless Steel Cable
----------	--

6m retractable lanyard



Features

Casing is made of light Aluminium Alloy and comes with 25mm wide webbing. Swivel action eye prevents rope from twisting while working or in the event of a fall.

- Fully serviceable at the QSI facility.

Certified to: EN 360:2002

Product Codes

SRLWB06	6m Webbing Retractable Lanyard
---------	--------------------------------

Cable blocks



Features

These retractable cable blocks extend to 10m, 15m and 30m lengths and come in a tough, robust plastic casing.

Swivel hook attachment reduces twist problems while in use and helps the user when they need to turn around, etc. The hook also has a load indicator which shows green when safe to use and red when unit has had a substantial loading and should be inspected.

Unique to this unit is a spring at the base of the cable to stop it locking permanently if accidentally fully retracted. The user can simply push in against the spring to release the cable again, unlike other models which require the entire unit to be disassembled.

See also: "30m Retractable Block with Retrieval Winch" on page 185.

- Fully serviceable at the QSI facility.

Certified to: EN 360:2002

Product Codes

SRLS10	10m Cable Block
SRLS15	15m Cable Block
SRLS30	30m Cable Block



The spring at the base of our blocks prevents the cable from locking permanently when fully retracted accidentally. This allows the user to release the cable lock quickly and easily, unlike other brands which require the expensive disassembly of the entire block.

Cable blocks allow users a wide range of movement while maintaining a high level of safety. They can be positioned at the top of ladders or scaffolds, gently retracting and extending up to 30m as the user climbs and moves around, safe in the knowledge that any fall will be broken in a split second.

Slings

QSi designs and produces its slings using only the highest quality polyester webbing and synthetic stitching. Slings are used to create temporary anchor points where permanent anchor points are not available. Ideal for use around large pipes, beams, pylons, and other structures where normal hooks are not suitable.

Note on Standards:

Our slings conform to EN 795 as there is no comparable AS/NZS standard for slings. However, AS/NZS 1891.1:2007 requires attachment points to have a 15kN MBL rating, which our slings exceed with a 24kN MBL.

Beware of manufacturers claiming their slings are AS/NZS 1891.4 compliant as this is merely a labelling and documentation standard, not an actual equipment standard.

Webbing Width Chart (1:1 scale)

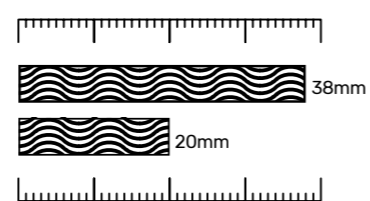

20mm webbing endless round sling



Features

Made with 20mm webbing.
MBL: 24kN.

Certified to: EN 795

Product Codes

HS807(10)	1 metre 20mm Webbing Endless Round Sling
HS807(15)	1.5 metre 20mm Webbing Endless Round Sling
HS807(20)	2 metre 20mm Webbing Endless Round Sling

38mm webbing endless round sling



Features

Made with 38mm webbing.
MBL: 24kN.

Product Codes

SLIWEBRY6	Webbing Endless Round Sling - 0.6m
SLIWEBRY12	Webbing Endless Round Sling - 1.2m
SLIWEBRY24	Webbing Endless Round Sling - 2.4m

Webbing endless round sling - with wear protection sheath

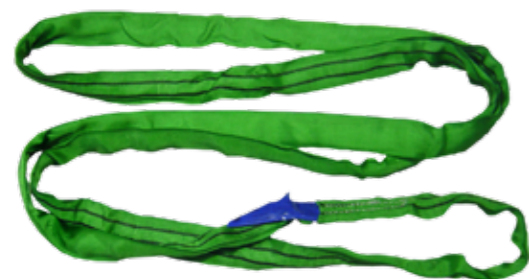

Features

QSi's industrial strength webbing endless round sling includes a wear protector ensuring long life and increased user safety.

This makes it perfect for anchorage around poles, beams and other high-friction areas where regular slings would wear out much faster.

A safe working load of 2000kg gives you a level of security far greater than standard industrial slings.

Product Codes

SLIWEBRG1	Webbing Endless Sling - Industrial Strength - 1m
SLIWEBRG2	Webbing Endless Sling - Industrial Strength - 2m

How to use a sling

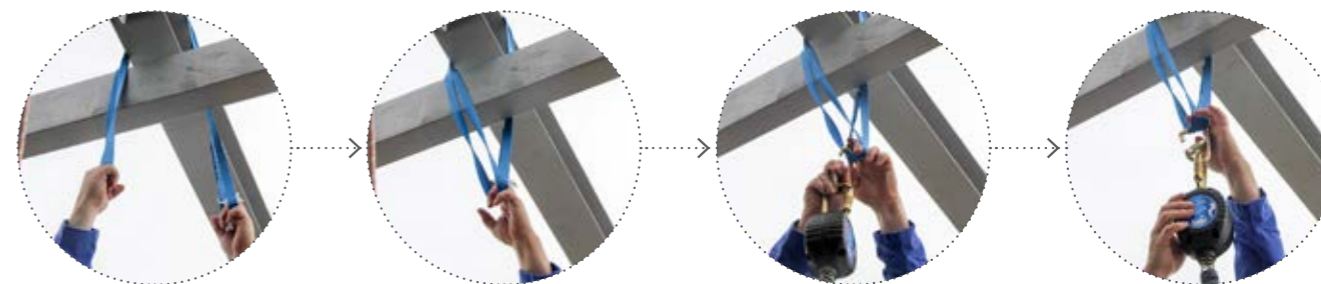

Step 1

Drape sling over anchor point, hold both ends.

Step 2

Bring both end loops of sling together.

Step 3

Feed carabiner through both loops.

Step 4

Ensure sling is not caught in gate before locking carabiner.

Personal adjustable sling - 1.5m



Features

Personal Adjustable Sling adjusts from as long as 1.5m to as small as 620mm.
MBL: 17kN

Product Codes

SLIADJPN	Personal Adjustable Sling 1.5m
----------	--------------------------------

Cross arm sling



Features

Anchor sling designed to thread around anchorage point and back through itself.

- Three layers of webbing give extra security.
- Standard length: 84cm
- Customised lengths also available on request, but please remember that longer lengths add to the overall fall distance.
- Available with protective wear shield to prevent damage to webbing from abrasive surfaces
- MBL: 24kN

NOTE: While the carabiner can pass freely through the large ring, the standard model requires that the carabiner be removed before threading sling through the ring. It takes a little longer to set up but cannot feed back through itself once carabiner is reattached.

Product Codes

SLICARM	Cross Arm Sling
SLICARMLR	Cross Arm Sling with Large Ring
SLICARMP	Cross Arm Sling with Protective Shield
SLICARMLRPS	Cross Arm Sling with Large Ring and Protective Shield

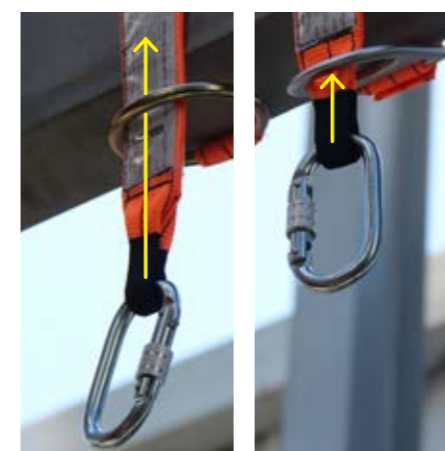

Carabiner can pass through large ring

Carabiner cannot pass through standard ring

Daisy chain sling

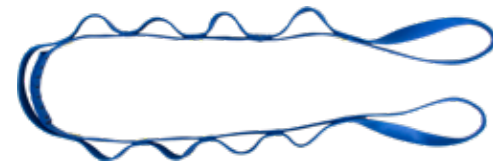

Features

Made with 20mm webbing. Stitched loops allow quick changes in length by simply moving carabiner between loops. Each loop is rated to 3kN.

Product Codes

HS807-DC	Daisy Chain Sling - 20mm Webbing 1.4m
----------	---------------------------------------

Connectors

Our connectors can be used for a variety of tasks and come in several lengths to suit a customer's requirements. They are made from UV stable, AS/NZS approved webbing and kernmantle rope.

Quick draw connector



Features

Available in various lengths, with or without carabiners.

Product Codes

CONQD250	Quick Draw Connector - 250mm
CONQD250C	As above, with carabiners
CONQD350	Quick Draw Connector - 350mm
CONQD350C	As above, with carabiners
CONQD450	Quick Draw Connector - 450mm
CONQD450C	As above, with carabiners

NOTE: Length excludes carabiners. Each carabiner adds approx 100mm to total length of Quick Draw.

Quick Draw Length Chart (1:10 scale)

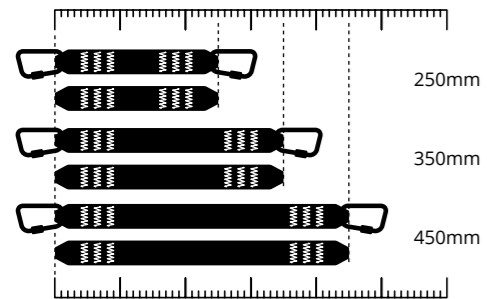

Short lanyard connector



Features

Sturdy, short webbing lanyard with a carabiner and a double action hook. Available in various lengths.

Product Codes

S0103	Short Lanyard Connector - 300mm
S0105	Short Lanyard Connector - 500mm
S0106	Short Lanyard Connector - 600mm

NOTE: Length is measured to the inside edges of attachment hardware as illustrated above.

Short Draw Length Chart (1:10 scale)

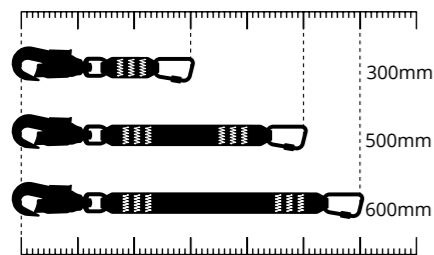

Three-way lanyard connector



Features

The Three-way Lanyard Connector is designed for use with a back-up line, providing extra stability and security when ascending and descending ropes.

The 60cm arm to be used on ascender, the short 30cm arm used to connect to back-up line rope grab and/or chest ascender.

Product Codes

SLISPEL013	Three-way Lanyard Connector 13mm wide (30cm/60cm)
SLISPEL038	Three-way Lanyard Connector 38mm wide (30cm/60cm)

Rope lanyard connector, 21kn



Features

Strong 11mm kernmantle rope lanyard, available in various lengths (800mm pictured).

MBL: 21kN

Product Codes

S0108R	Rope Lanyard Connector 360mm
S0107R	Rope Lanyard Connector 800mm
S0109R	Rope Lanyard Connector 1600mm

Chest connectors



Features

Our Chest Centre Lanyards are available in several lengths.

Product Codes

S012	Chest Centre Lanyard
S012B	390mm Chest Centre Lanyard
S012C	490mm Chest Centre Lanyard
S012D	590mm Chest Centre Lanyard
S049	Chest Centre Lanyard with Shock Block

Restraint lanyard



Product Codes

S0106DSA	600mm Twin Aluminium Scaffold Hook Restraint Lanyard
----------	--

Gear Bags

Custom branding available on all gear bags

Height safety gear can often be heavy and cumbersome, so it makes sense to use a suitable bag to carry it in. Not only that, when you have invested a lot of money in gear that could save your life, you would be wise to protect that investment.

We stock a wide range of bags from lightweight backpacks through to heavy duty, reinforced PVC tote bags, all hand picked to be robust enough for our ropes, lanyards, harnesses and hardware.

Note: Colours and styles are subject to availability, and may change from time to time.

QSi gear bag - medium



Features

Size: 51cm w x 28cm h x 28cm d
Capacity: 35 litres

- Light-weight reinforced PVC fabric
- Large zip flap opening to main compartment
- Large inside zip mesh pocket
- Fully adjustable shoulder strap
- Additional handles on each end
- 100% PVC coated polyester

Product Codes

BAGGEARWRMBL	Gear Bag - Medium - Black
BAGGEARWRMOB	Gear Bag - Medium - Orange/Black
BAGGEARWRMRBL	Gear Bag - Medium - Bold Red/Black
BAGGEARWRMRB	Gear Bag - Medium - Royal Blue/Black

Note: Colours and Styles are subject to availability, and may change from time to time.

QSi gear bag - large



Features

Size: 61cm w x 38cm h x 38cm d
Capacity: 88.5 litres

- Heavy-duty reinforced PVC fabric
- Fully adjustable padded shoulder straps allow you to carry the bag as a backpack
- Large zip flap opening to main compartment
- Large inside zip mesh pocket
- ID pocket on side
- Additional handles on each end
- 50% PVC/50% Polyester with double-gauge polypropylene webbing

Product Codes

BAGGEARWRLY	Gear Bag - Large - Yellow/Black
BAGGEARWRLRBL	Gear Bag - Large - Royal Blue/Black
BAGGEARWRLRB	Gear Bag - Large - Bold Red/Black

Note: Colours and Styles are subject to availability, and may change from time to time.

QSi barrel bag



Features

Size: 25cm w x 50cm h x 25cm d

- 600 D Polyester
- Zip main compartment
- Long carry handles so can go over shoulder
- Zip end pocket

Product Codes

BAGBARRELR	Red Barrel Bag
BAGBARRELB	Black Barrel Bag
BAGBARRELN	Navy Blue Barrel Bag
BAGBARRELRB	Royal Blue Barrel Bag

Note: Colours and Styles are subject to availability, and may change from time to time.

QSi basic sports bag



Features

Size: 51cm w x 34cm h x 35cm d
Capacity: 60 litres

- 600D polyester with PVC backing
- U-shaped main entry
- Generous end pockets-one wet pocket
- Strengthened carry handles
- Removable, adjustable shoulder strap
- Plastic feet on base
- Baseboard

Product Codes

SPORTSBAGB	Black Basic Sports Bag
SPORTSBAGBL	Blue Basic Sports Bag
SPORTSBAGR	Red Basic Sports Bag

Note: Colours and Styles are subject to availability, and may change from time to time.

QSi duffle bag



Features

Size: 46cm w x 28cm h x 23cm d
Capacity: 29 litres

- 600D Polyester
- Elastic mesh water bottle pocket
- Large zip main compartment with pull cord
- Shoulder strap
- Grab handles

Product Codes

BAGDUFFLEB	Royal Blue Duffle Bag
BAGDUFFLEOB	Orange and Black Duffle Bag
BAGDUFFLERB	Red and Black Duffle Bag

Note: Colours and Styles are subject to availability, and may change from time to time. Accessories not included.

QSi kit bag



Features

- Size: 28.5cm dia x 49cm h
Capacity: 27 litres
- 600D polyester with PVC backing
 - Deep duffel bag
 - Nylon drawstring
 - Zip shoulder strap converts to backpack straps

Note: Colours and Styles are subject to availability, and may change from time to time.

Product Codes

BAGKITBL	Black Kit Bag
BAGKITRB	Red Kit Bag
BAGKITRBLUE	Royal Blue Kit Bag

QSi backpack



Features

- Size: 38cm w x 43cm h x 17cm d
Capacity: 28 litres
- 600D polyester with PVC backing
 - Compression straps
 - Bungee with reflective tape for safety
 - Padded back and straps
 - Large front zip pocket
 - 2 side mesh pockets
 - Hidden hole for headphones with cord tidy velcro loops inside
 - Moulded plastic handle

Note: Colours and Styles are subject to availability, and may change from time to time.

Product Codes

BACKPACKBLACK	Black Backpack
BACKPACKBY	Yellow Backpack
BACKPACKBRB	Blue Backpack
BACKPACKRB	Red Backpack

QSi waterproof backpack



Features

- Size: 32cm w x 64cm h x 19.5cm d
Capacity: 35 litres
- 100% waterproof heat welded seams
 - Lightweight reinforced PVC fabric
 - Roll-Top closure with cinch straps
 - Padded, adjustable shoulder straps with adjustable chest straps
 - Large waterproof zip pocket
 - Contrast zips and webbing
 - 100% PVC coated polyester 250D

Note: Colours and Styles are subject to availability, and may change from time to time.

Product Codes

BACKPACKWPSB	Black Waterproof Backpack
BACKPACKWRB	Black and Bold Red Waterproof Backpack
BACKPACKWPYB	Black and Yellow Waterproof Backpack

QSi drawstring bag



Features

- Size: 39cm w x 49cm h
Capacity: 2 litres
- 210D polyester
 - Drawstring closure
 - Back cords to use over the shoulder or as a backpack
 - Reinforced eyelets at base

Note: Colours and Styles are subject to availability, and may change from time to time.

Product Codes

HARBAGB	Black Drawstring Bag
HARBAGRB	Royal Blue Drawstring Bag
HARBAGN	Navy Blue Drawstring Bag
HARBAGRC	Red Drawstring Bag
HARBAGO	Orange Drawstring Bag

QSi basic sports bag



Features

- Size: 39cm w x 49cm h
Capacity: 2 litres
- Fluoro polyester
 - Reflective material
 - Draw closure
 - Use back cords as shoulder bag or backpack
 - Reinforced reflective eyelets at base

Note: Colours and Styles are subject to availability, and may change from time to time.

Product Codes

BACKSACK	Hi Vis Drawstring Bag with Reflective Tape
----------	--

QSi Hi Vis backpack



Features

- Size: 30cm w x 46cm h x 25cm d
Capacity: 35 litres
- 600D polyester
 - 3M Scotchlite reflective material on front, sides and shoulder straps.
 - Large double zip main compartment.
 - Padded back and adjustable shoulder straps.
 - Front zip pocket with internal zip pocket
 - 2 side elastic top mesh pockets and 2 metal air vents.
 - Strong moulded plastic handle
 - Rubber feet on base.

Note: Colours and Styles are subject to availability, and may change from time to time.

Product Codes

BACKPACKHIVIS	Hi Vis Backpack with Reflective Tape
---------------	--------------------------------------

Tote bags



PVCBAB
25cm ø x 50cm l

Features

Our tote bags are robust, roomy and designed to hold all your height safety gear. The strong PVC fabric, nylon webbing and heavy duty stitch patterns work together to ensure your bag can cope with a lot of weight.

Product Codes

PVCBAB(COLOUR)	Barrel Bag
PVCBOB(COLOUR)	Boot Bag
PVCGBS(COLOUR)	Small Gear Bag
PVCGB	Medium Gear Bag
PVCGBL(COLOUR)	Large Gear Bag
PVCGBXL	Extra Large Bag
PVCGBPRE	Premium Gear Bag

Note: Colours and Styles are subject to availability, and may change from time to time.



PVCBOB
26cm h x 32cm w x 50cm l



PVCGBS
32cm h x 32cm w x 66cm l



PVCGBL
32cm h x 32cm w x 80cm l



PVCGBXL
32cm h x 32cm w x 100cm l



PVCGBPRE
32cm h x 32cm w x 65cm l

PVC rope bags



200m 100m 50m
36cm ø x 102cm h 30cm ø x 90cm h 30cm ø x 50cm h

Note: Colours and Styles are subject to availability, and may change from time to time.

Features

Our Rope Bags come in sizes to suit a wide variety of rope lengths up to 200m. They have many great features to make hauling your height safety equipment so much easier. There are also customising options to give your bags the personal touch. Colours can be made to order.

Features include:

- Robust adjustable shoulder straps
- Draw string toggle closing
- Eyelets in bottom for rope to be tied through
- Wear-webbing to protect rope
- Generous capacity allows a helmet or harness to be carried along with the rope.
- Many colours available
- Customised printing on bags available (POA)

Because longer ropes are much heavier, the 200m bag also includes easy carry handles on the side at the top of the bag to enable two people to lift it easily.

Product Codes

RB50	Standard Rope Bag - 50m
RB100	Standard Rope Bag - 100m
RB200	Standard Rope Bag - 200m

Glove bags



Features

Designed for storage of electrical workers' gloves.

Available in two sizes:

- Large: 32cm w x 32cm h x 80cm d
- Small: 32cm w x 32cm h x 66cm d

Product Codes

GLOVELG	Large Glove Bag
GLOVEBSM	Small Glove Bag

Note: Colours and Styles are subject to availability, and may change from time to time.

Lifting bags



Features

Designed for heavy duty lifting of tools and equipment.

- Available in various sizes
- Made of heavy duty PVC material and webbing
- 80kg work load limit
- Break load limit is tested to 10 x times the work load limit.

Product Codes

LIFTBAG01	Lift Bag Open Top Yellow/Black 32cm x 32cm x 66cm
LIFTBAG02	1.8m Pole Bag Navy
LIFTBAG03	Square Bag Navy/Red 40cm x 70cm x 60cm
LIFTBAG04	Square Bag Black/Red 50cm x 30cm x 44cm

Note: Colours and Styles are subject to availability, and may change from time to time.

Scaffold height safety kit



Features

This kit gives you everything you need to work safely at height on industrial scaffolding. The 2m adjustable shock absorbing lanyard clips onto scaffold tubing quickly and easily, and allows the user to work in restraint. The sling can create a safe anchor point when you are unable to clip onto the scaffolding itself. Also available with a premium full body Harness, see pg. 119.

Kit Contents:

- 1 x SBE2KQR Full body harness with quick release buckles
- 1 x HS807-15 1.5 metre 20mm Webbing Endless Round Sling
- 1 x S017 2m Adjustable Single Leg - 1 Double Action hook and 1 scaffolding hook
- 1 x HELMETQTECHCO Industrial Safety Helmet
- 1 x BAGKITRB Gear Bag
- 1 x MC001 Carabiner

Product Codes

SK01	Scaffold Height Safety Kit
------	----------------------------

Construction height safety kit



Features

This kit is designed to provide height safety protection for construction workers. The large anchor sling allows the user to create a safe anchor point from beams and other structural members, and the retractable block allows a wide range of movement without compromising safety. Also available with a premium full body Harness, see pg. 119.

Kit Contents:

- 1 x SBE2KQR Full body harness with quick release buckles
- 1 x HS807-15 1.5 metre 20mm Webbing Endless Round Sling
- 1 x SRL2002 2.5m Retractable Block
- 1 x BACKPACKRB Backpack
- 1 x MC001 Carabiner

Product Codes

CK01	Construction Height Safety Kit
------	--------------------------------

Using a Roof Kit

Roof kits are designed to provide a simple, secure, temporary safety line on pitched roofs. All they require is a secure anchor point and a roof ridge-line above where the user will work. There are several ways to create a safe anchor point for your rope, such as attaching a sling to an existing solid structure or using a QSI Temporary Roof Anchor or Ground Anchor. Always ensure the anchor point is on the opposite side of the roof from where you wish to work, and always follow instructions supplied with your equipment.

All QSI Ropes and Rope Grab combinations are tested and certified to AS/NZS 1891.3

Step 1: Setting up Anchor Point



Anchor Point using Temporary Roof Anchor

1. Remove row of four roof fixings and position anchor on roof so holes are aligned.
2. Fix Anchor to roof with supplied screws through existing holes.



Anchor Point using Endless Sling:

1. Locate a suitable object such as a sturdy tree, the wheel or axle of a car or truck, or a large, concreted fence post.
2. Loop sling around object and back through itself.

Step 2: Setting up Rope



1. Fix rope to anchor point using supplied carabiner.
2. Using the bagged rope as a dolly, throw bag over roof. Alternatively, use a QSI Throw Dolly to toss a draw line across the roof, attach rope to line and pull across roof.



3. Attach Rope Grab to rope and tie tail end of rope to a suitable attachment point to prevent lateral movement.

Step 3: Attaching to Rope



1. Attach chest connector to harness and rope grab before you leave the ground.
2. Always work from a position below the apex of the roof. Only use short lanyard connectors of 450mm or less (inc hooks/carabiners).



1. Refer to instruction manual supplied with roofing kit for specific safety and best-practice instructions.

Economy roofing kit - kernmantle



Features

Our Economy Roofing Kit is a simple roof kit intended for basic roof work. It is anchored on the opposite side of the roof to where the work is done.

A manual rope grab keeps the user attached to the rope.

Rope and Rope Grab combinations are certified to AS/NZS 1891.3.

Kit Contents:

- 1 x 20 meters of 11mm kernmantle rope with 1 x sewn eye loop and 1 x stop knot (SKR11/20-SELISK)
- 1 x RG011 Manual rope grab
- 1 x S009KC Mini energy absorber block with carabiners
- 1 x MC001 carabiner
- 1 x HS807-15 1.5 metre 20mm Webbing Endless Round Sling
- 1 x SBE2K Full body harness
- 1 x 50m rope bag (BAGKITRB)

Product Codes

RKE10	Economy Roofing Kit - Kernmantle
-------	----------------------------------

Recommended accessories



Temporary Roof Anchor

Throw Dolly

Commercial roofing kit - kernmantle



Features

The commercial roofing kit was designed for professional tradesmen who need safe, temporary access to roof tops. It has 30 meters of kernmantle rope to allow for greater flexibility and more applications. The sewn end is anchored to a suitable point on the opposite side of the roof to where the work is done. A robust steel rope grab keeps the user attached to the rope. There is no need for a shock block due to the kernmantle rope having sufficient stretch to reduce the fall force. The kit is designed to be used in restraint and the fall distance must be kept below 600mm.

Rope and Rope Grab combinations are certified to AS/NZS 1891.3.

Kit Contents:

- 1 x 30 meters of 11mm kernmantle rope with 1 x sewn eye loop and 1 x stop knot (SKR11/30-SELISK)
- 1 x RG012 rope grab
- 2 x MC001 carabiner
- 1 x HS807-10 1 metre 20mm Webbing Endless Round Sling
- 1 x HS807-20 2 metre 20mm Webbing Endless Round Sling
- 1 x SBE9 Full body harness
- 1 x 50m rope bag (BAGKITBL)

Product Codes

RKE07	Commercial Roofing Kit
-------	------------------------

Recommended accessories



Temporary Roof Anchor

Throw Dolly

Priority roofing kit



Features

Our Priority Roofing Kit is a practical kit that makes it easier to work on roofs without anchor points. The key is the QSI anchor knot in the middle of the rope, this will not give no matter which way the force is applied.

Rope and Rope Grab combinations are certified to AS/NZS 1891.3.

Kit Contents:

- 1 x 50 meters of Kernmantle rope with QSI anchor knot in centre with rope shield protector
- 1 x RG004 Micro rope grab
- 1 x S009KC Mini energy absorber block with carabiners
- 2 x MC002 carabiners
- 2 x SLIWEBRG1 industrial strength slings
- 1 x RB50 Heavy Duty PVC rope bag

Product Codes

RKEP01	Priority Roof Kit
--------	-------------------

Recommended accessories

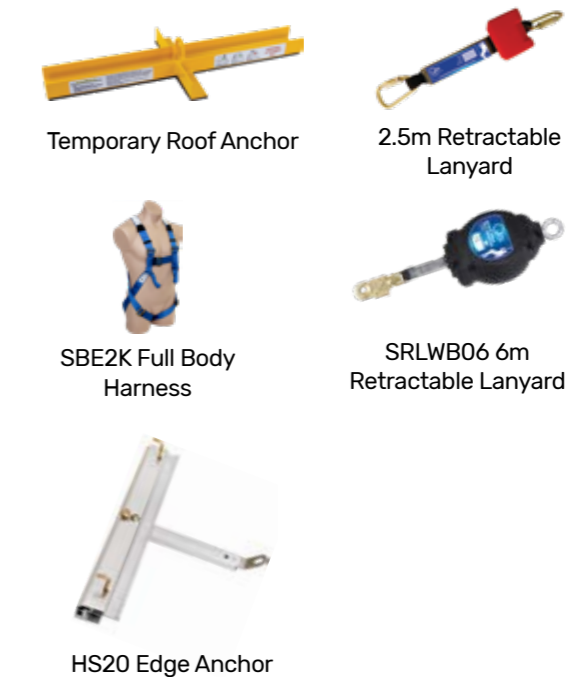

Temporary Roof Anchor

2.5m Retractable Lanyard

SBE2K Full Body Harness

SRLWB06 6m Retractable Lanyard

HS20 Edge Anchor

Temporary anchor points

Most commercial buildings are not built with height safety in mind, so it can be difficult to find a safe, secure anchor point for your rope or lanyard. With this in mind, we supply a range of innovative permanent and temporary anchor systems that allow you to utilize the natural features of commercial buildings to create a safe working environment.

Parapet anchor

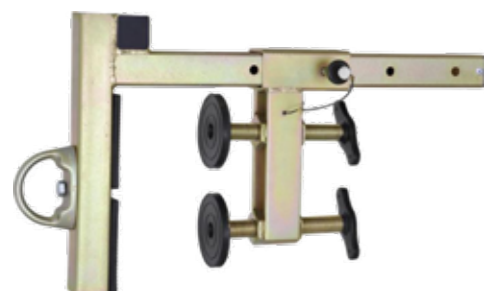

Features

- Material: High strength steel galvanized to provide corrosion protection.
- MBL: 5000 lbs/23kN
- Flange width adjustable from 60 mm to 360 mm.
- Net Weight: 8575g

Certified to: EN 795: 2012 Type B and ANSI Z 359.1: 2007

Product Codes

HSSA11 Parapet Anchor

Beam anchor trolley

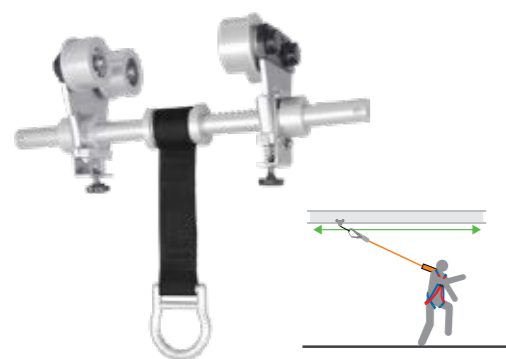

Features

Mount the Beam Anchor Trolley onto an I-Beam to create an instant rolling anchor point that will follow the user as they work. Must be mounted on a level horizontal beam to ensure the user does not travel in the event of a fall.

- Material: Aluminium and Stainless Steel
- MBL: 5000lbs/23kN
- Flange width adjustable from 80mm to 250mm.
- Net Weight: 4.155 kgs ±100g

Certified to: EN 795: 2012 Type B and ANSI Z 359.1: 2007

Product Codes

MHA005 Beam Anchor Trolley

Edge anchor



Features

The Edge Anchor is adjustable for depth to suit a variety of roof cladding profiles. An optional large cladding insert enables the anchor to be fitted onto deeper roof profiles. It is robust, lightweight, collapsible & portable for easy transport, storage and usage. The energy absorbing arm with fall indicator provides additional safety for the user.

- Material: High Strength Aluminium Alloy.
- Minimum Breaking (System) Strength: 15 kN.
- Net Weight: 3000gm ± 10gm.
- Conforms to EN 795 : 2012 Type B

Product Codes

HS20 Edge Anchor

Door anchor



Features

Create a safe, temporary anchor point for up to two users using most single door frames. Designed to be installed on frames from 60cm to 125cm wide. Comes complete with a carry bag.

- Material: Aluminium Alloy
- Door frame width range: 60cm - 125cm
- Net Weight: 4.73 kg ±100g
- MBL: 13 kN

Certified to: EN 795: 2012 Type B, TS 16415: 2013 Type B and ANSI Z 359.1:2007

Product Codes

HS802 Door Anchor

Semi-permanent anchor points

Concrete anchor

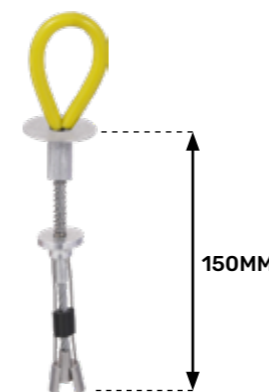

Features

- Material: High strength steel galvanized to provide corrosion protection.
- MBL: 5000 lbs/23kN
- Flange width adjustable from 60 mm to 360 mm.
- Net Weight: 8575g

Certified to: EN 795: 2012 Type B and ANSI Z 359.1: 2007

Product Codes

HSSA16 Concrete Anchor

Aluminium point anchor

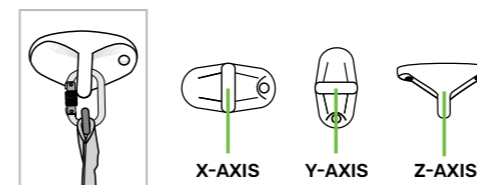

Features

- Suitable for use with carabiners only.
- Material: Aluminium Alloy
- MBL: 5000lbs/23kN
- Finish: Natural Silver
- Net Weight: 308g
- Product is not supplied with mounting bolts. Refer to instruction manual for more information.

Certified to: EN 795: 2012 Type B and ANSI Z 359.1: 2007

Product Codes

HSSA09 Aluminium Point Anchor

Steel point anchor



Features

- Material: Steel
- MBL: 5000lbs/23kN
- Net Weight: 450±10g
- Process: Forged
- Product is not supplied with mounting bolts. Refer to instruction manual for more information.

Certified to: EN 795: 2012 Type B, TS 16415: 2013 Type B and ANSI Z 359.1:2007

Product Codes

HSSA10	Steel Point Anchor
--------	--------------------

Steel point anchor



Features

- Material: Steel
- MBL: 5000lbs/23kN
- Net Weight: 529±10g
- Process: Forged

Certified to: EN 795:2012 and ANSI Z 359.1:2007

Product Codes

HSSA10A	Steel Point Anchor
---------	--------------------

QSi's temporary roof anchor: simple, safe and versatile

QSi's patented Temporary Roof Anchor provides a secure attachment point by fixing directly to the timber joists and purlins through corrugated roofing iron. The patented design and heavy duty steel construction spreads any potential load across the roof structure, and the foam padding protects the corrugated roofing from damage.

Temporary roof anchor



Features

- Temporary roof anchor designed for single person use.
- Designed to be attached onto AS/NZS certified New Zealand Wooden Roof structures.
- This roof anchor should only be used on roofs that are structurally sound.
- In order to safely arrest a fall, ensure that the minimum clearance distance is provided.
- The roof anchor must be installed by a competent person who is trained to work at height.
- New Zealand Patent Application No. 713603
- Australian Patent Application No. 2015246153
- New Zealand Registered Design Application No. 419489

Certified to: AS/NZS 5532:2013

Product Codes

RAQTECHV1	Temporary Roof Anchor
-----------	-----------------------



Safe to attach the roof anchor on the other side of the roof

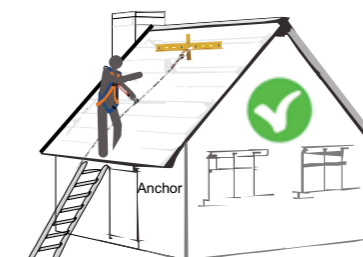

Safe to attach the roof anchor above you

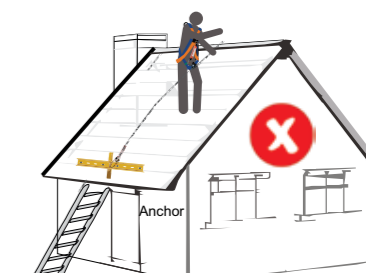

NEVER attach the roof anchor below you

Temporary vertical anchor line systems

Once your anchor point is in place, you need a line system to attach yourself to. These systems mount easily on a variety of permanent and temporary anchor points to provide a safe line to work from. Anchorage lines are available in lengths of 30m.

Guided fall arrester with energy absorbing block on flexible anchorage line



Features

The fall arrester is made of stainless steel and works on 12mm diameter Kernmantle rope.

Certified to: EN 353-2:2002

- The Arrester is incorporated permanently on the anchorage line, and comes with an energy absorbing block.
- The anchorage line has one side loop for connector and the other side a stop knot.

Product Codes

RG2004	Guided Fall Arrester with Energy Absorbing Block on Flexible Anchorage Line
---------------	---

Guided fall arrester on flexible anchorage line with energy absorbing block



Features

Comprised of a 12mm diameter Kernmantle rope anchorage line with an removable rope grab made of high strength aluminium Alloy.

Certified to: EN 353-2:2002

- The anchorage line has an energy absorber at the anchorage end and a stop knot at the other end.

Product Codes

RG2006	Guided Fall Arrester on Flexible Anchorage Line with Energy Absorbing Block
---------------	---

How to build your own rope kit

Step 1. Choose your rope diameter



Product Codes

SKR11	11mm Kernmantle rope
SKR12	12mm Kernmantle rope

Step 3. Choose your rope end options



Sewn Eye Loop

Available on one or both ends. May also include a Carabiner (see pg. 197)



Stop Knot

Available on one end only

Product Codes

	Rope only (blank ends)
-SEL	1 x Sewn eye loop
-SELSK	1 x Sewn eye loop & 1 x stop knot
-2SEL	2 x Sewn eye loops

Each of these options requires an additional 0.5m of rope which will be added to the total length.

Step 2. Choose your rope length

Product Codes

SKR11/	Available sizes - 5, 10, 15, 20, 25, 30, 35, 40, 45, 50 meter lengths
SKR12/	Available sizes - 5, 10, 15, 20, 25, 30, 35, 40, 45, 50 meter lengths

Step 4. Choose your optional extras

Gear Bags

Grab one of our gear bags for your kit. See our bag range from page 157.



Rope Grabs

Add a rope grab to your kit. See our rope grab range from page 176.



Carabiners or Hooks

Add carabiners or hooks to your kit. See our range from page 195.



NOTE - If you require a rope grab, carabiner or hook fitted to a rope, please contact us *before* manufacture starts.

Ordering your kit. Create your own rope kit

Example: You need 20mtrs of 11mm Kernmantle Rope with sewn eyes on both ends.

Here is the code you would use: **SKR11/20-2SEL**

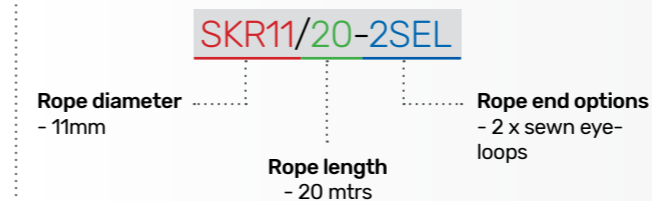

Example: You need 50mtrs of 12mm Kernmantle Rope with one sewn eye-loop and one stop knot.

Here is the code you use: **SKR12/50-SELSK**

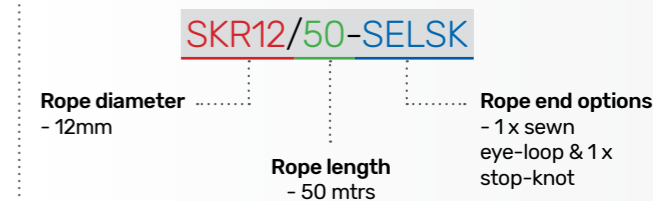

Note - If this all seems a little overwhelming and you need some assistance in choosing the best kit for your needs, just give our sales team a call, and we'll be happy to explain the options!

Kernmantle rope



Features

All QSI's Kernmantle ropes have a high strength polyester sheath to protect the rope against sharp edges during a fall. Sold by the metre (or see next page for ready-made rope kits)

Certified to: AS/NZS 4142.3: 1993 or EN Standard also available

Product Codes

SKR11	11mm Kernmantle Rope (Orange) AS/NZS Standard
SKR12	12mm Kernmantle Rope (Black and Yellow) AS/NZS Standard
SKR13BC	13mm Kernmantle Rope (Black with Cyan Fleck) AS/NZS Standard
SKR130	13mm Kernmantle Rope (Orange) AS/NZS Standard

Kernmantle prussic rope

Product Codes

SKR08	8mm Kernmantle Prussic Rope
-------	-----------------------------

Throw dolly



Features

The QSI Throw Dolly makes it much easier for users to throw a rope accurately over a beam, tree branch or other supporting structure.

Product Codes

TD001	250g Throw Dolly - 20m rope and bag
TD002	300g Throw Dolly - 20m rope and bag
TD003	350g Throw Dolly - 20m rope and bag

Ready-To-Go rope



Features

These ready-made rope packages are an ideal starting point for those who are new to height safety.

Rope is Certified to: AS/NZS 4142.3:1993.
EN Standard also available.

Package includes:

- A length of kernmantle rope.
- Sewn and labelled with a captive eye and stopknot.
- A carabiner through the loop.
- A robust bag to carry it in.
- Rope - Ready to go

Product Codes

READY20GO	20m 11mm Kernmantle Rope with sewn eye+stopknot & sewn label & Carabiner in Bag
READY30GO	30m 11mm Kernmantle Rope with sewn eye+stopknot & sewn label & Carabiner in Bag
READY40GO	40m 11mm Kernmantle Rope with sewn eye+stopknot & sewn label & Carabiner in Bag
READY50GO	50m 11mm Kernmantle Rope with sewn eye+stopknot & sewn label & Carabiner in Bag

Optional Accessories

- Rope Grab attached to line
- Stop Knot.
- Custom bag branding

Rope shield



Features

Our PVC Rope Shield edge protector has Velcro closing making it easy to fit after rope has been set up. To fit 8-16mm rope.

Product Codes

SRS01	PVC Rope Shield edge protector - 450mm
-------	--

Rope eye protectors



Features

Two models suitable for 8-11mm and 11-14mm diameter rope. Used on rope loops as a wear protector.

Product Codes

RP2087	Rope Eye Protector - 8-11mm
RP2088	Rope Eye Protector - 12-16mm

Webbing protective sleeve



Features

Designed to protect flexible anchorage lines against abrasion on sharp edges.

- Made of 44mm polyester tubular webbing.
- Moveable along the length of the anchorage line.
- Non-detachable.
- Standard length is 30cm, other lengths available on request.

Product Codes

PR01	Polyester Protective Sleeve
------	-----------------------------

PVC removable protective sleeve



Features

Designed to protect flexible anchorage lines against abrasion due to friction.

- Made of flexible PVC.
- Detachable from line thanks to hook and loop fastening.
- Open width: 130mm. Folded width: 50mm.
- Standard length: 55cm.

Product Codes

PR02	PVC Removable Protective Sleeve
------	---------------------------------

Rope grabs

These devices allow users to safely ascend and descend ropes. When the user puts weight on their harness, either intentionally or in a fall, the Rope Grab mechanism binds with the rope to prevent the user from falling. There are various types of rope grabs that operate in different ways.

How to choose a Rope Grab

There are several features to consider when choosing a rope grab. Use the icons to help you choose the most suitable for you:



Removable or Fixed to the Rope

Icon indicates whether or not the rope grab is fixed to the rope or removable without having to slide it off the end of the rope. Fixed rope grabs are permanent if the rope has a stop knot or loop at each end.



Polyamide or Kernmantle Rope

Icon indicates whether the rope grab is suitable for Polyamide or Kernmantle rope. Note: all rope grabs on Polyamide rope must be used with a shock absorbing block.



Manual or Automatic Fall Arrest

Icon indicates whether rope grab has an automatic or manual fall arrest mechanism. Manual rope grabs grip the rope by default and must be manually released to enable the user to move. Automatic rope grabs slide freely until a fall causes them to lock onto the rope.



Steel or Alloy Construction

Icon indicates whether rope grab is of steel or aluminium alloy construction. Choose steel for added strength and long life, or alloy when light weight is important.

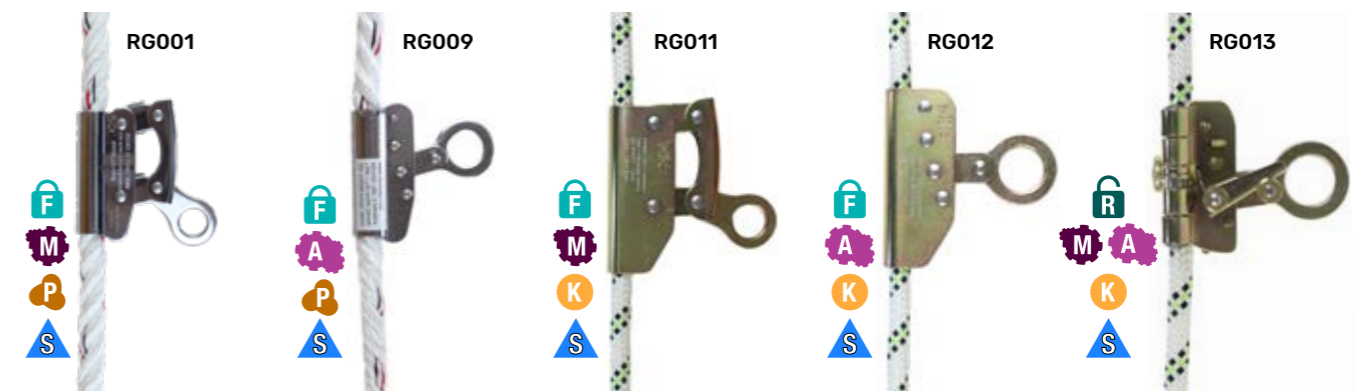

Steel rope grabs

Features

Our steel rope grabs are tested to the AS/NZS 1891.3 and EN standards. Be sure to choose the model that suits the type of rope you wish to use. Contact us for more information.

Certified to: AS/NZS 1891.3 and/or EN567 depending on rope grab.

Product Codes

RG001	Fixed Steel Rope Grab - Manual Fall Arrest - for 12-16mm Polyamide rope
RG009	Fixed Steel Rope Grab - Automatic Fall Arrest - for 16mm Polyamide rope
RG011	Fixed Steel Rope Grab - Manual Fall Arrest - for 11-12mm Kernmantle rope
RG012	Fixed Steel Rope Grab - Automatic Fall Arrest - for 11-12mm Kernmantle rope
RG013	Removable Steel Rope Grab - Automatic and Manual Fall Arrest - for 11-12mm Kernmantle rope

Note: QSI Rope Grabs have been tested on QSI supplied rope only and we cannot guarantee that they will work correctly on rope from other manufacturers.



Alloy rope grabs

Features

Strong, light weight alloy rope grabs tested to the AS/NZS 1891.3 and EN standards. Suitable for use on a wide diameter range of kernmantle rope.

Certified to: AS/NZS 1891.3 and/or EN341 Class A depending on rope grab.

Note: QSI Rope Grabs have been tested on QSI supplied rope only and we cannot guarantee that they will work correctly on rope from other manufacturers.

Product Codes

RG004	Removable Alloy Rope Grab - Manual Fall Arrest - 11mm to 16mm Kernmantle
RG005	Fixed Alloy Rope Grab - Automatic Fall Arrest - 12mm Kernmantle
RG006	Removable Alloy Rope Grab - Automatic and Manual Fall Arrest - 11mm to 12mm Kernmantle

Attaching an RG006 Rope Grab



Step 1

Step 2

Step 3

Step 4

Step 5

Step 6

Ascenders - alloy



Features

Robust alloy rope ascender in left and right handed, and chest versions. Suitable for use with 8-13mm kernmantle rope.

Certified to: EN567

Product Codes

RG8088L	Left Handed Ascender
RG8088R	Right Handed Ascender
RG8088C	Chest Ascender

2-way stop descender - alloy



Features

The unique feature of this descender is the double-stop action. When under load, the descender automatically stops, locking onto the rope; if the user panics and either squeezes handle too hard or lets go, it will also stop. For use on 11mm kernmantle rope.

- SWL 150Kg
- Weight: 465g

Certified to: EN341 Class A

Product Codes

MP219911	Descending Device - Alloy
-----------------	---------------------------

2-way stop grip descender - alloy



Features

Works in a similar way to the standard 2-way Stop Descender, but with a more ergonomic grip handle. Ideal for descent on a single rope, it is equipped with a unique Self Braking System which initiates the brake as soon as the handle is released, or clasped too tightly. Works on 10mm to 12mm diameter Kernmantle rope

- Net Weight: 335.5g
- Finish: Coloured, Anodized

Certified to: EN341 Class A

Product Codes

MP401	Grip Descender - Descender Device for 10mm-12mm Kernmantle Rope
--------------	---

Telescopic pole system

Our Telescopic Pole is a perfect solution for creating overhead anchors at otherwise unreachable heights. Made of lightweight fibreglass, it is easy to carry and provides a simple, effective way to install an anchorage point from a distance. Comes with the Aluminium Anchorage hook (MH154), to anchor at the required distance.

Features include:

- Total weight (without hook): approx. 4.6kg
- Working reach when extended: 10.5m
(This includes 8.95m of fully expanded length, the 1m extension section and 1.55m of user's height.)
- Open expanded length of Telescopic Pole: 7.95m.
- Closed length of Telescopic Pole: 1.95m
- Voltage Rating: 30KV

Telescopic pole

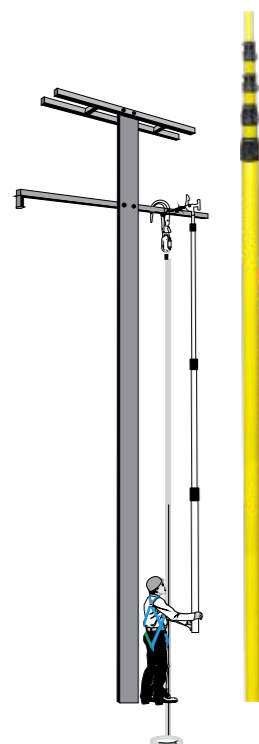

Features

- Material: Fiberglass
- Maximum Length: 7.95m
- Minimum Length: 1.95m
- Weight: 3800g

Product Codes

HS815(04)	Telescopic Pole
-----------	-----------------

Head



Features

Attaches to the top of the Telescopic Pole.

- Length: 240cm
- Weight: 185g

Product Codes

HS815(01)	Head
-----------	------

Extension section



Features

Attaches to the top of the Telescopic Pole to add an extra metre of height when required. Includes head attachment point for Hanging Hook.

- Length: 1m
- Weight: 425g

Product Codes

HS815(02)	Extension Section
-----------	-------------------

Installation / removal tool



Features

Attaches to the top of the Telescopic Pole to add an extra metre of height when required. Includes head attachment point for Hanging Hook.

- Length: 1m
- Weight: 425g

Product Codes

HS815(03)	Hanging Hook
-----------	--------------

Aluminium anchorage



Features

- Material: Aluminium Alloy
- Opening: 60mm
- Minimum Breaking Strength: 23kN
- Weight: 480g

Certified to: EN 362:2004 Class A and EN 795:2012 Type B

Product Codes

MH154	Aluminium Anchorage Hook
-------	--------------------------

Fall clearance and line deflection diagram

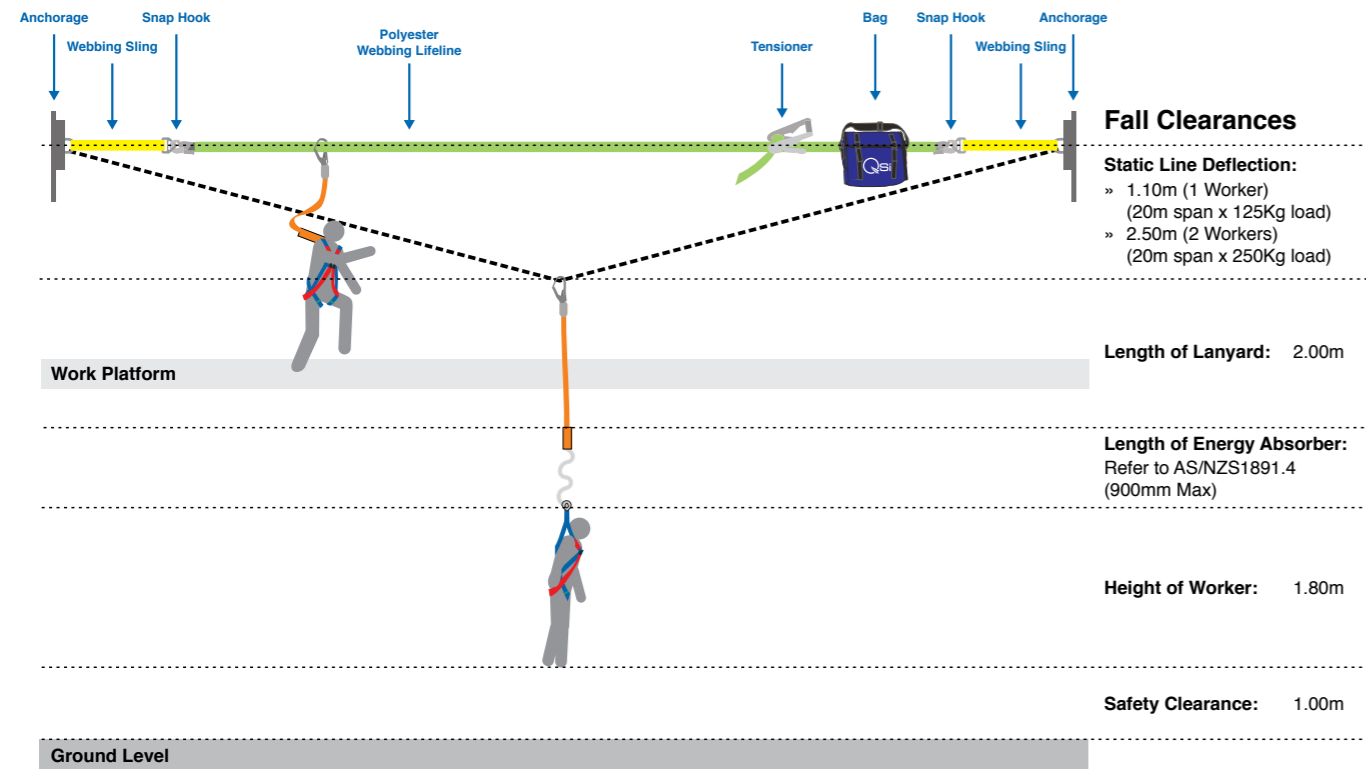

Horizontal life line - SLL3000



Features

It's rare that you'll find yourself in a situation where an ideal anchor point is in just the right place. That's where the horizontal life line comes in.

Using just two sturdy anchor points in the general area of your work space, you can set up a life line strong enough to take the weight of two users, giving you unprecedented freedom of movement to help you get the job done faster.

Specifications

- Two person temporary webbing life line with sturdy carry bag.
- Max length: 20m.

EN certified for two persons. Complies to EN 795 Class B.

Product Codes

SLL3000	Horizontal Life Line
---------	----------------------

Note: When used at full extension, beware of bowing effect in middle of lifeline. Set anchor point heights to compensate. See Fall Clearance and Line Deflection Diagram above.

4 Man temporary horizontal rope anchorage line - HS3001

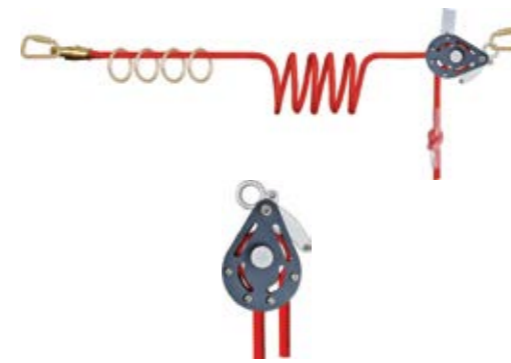

Features

- Rope type: kernmantle rope 16mm
- Tensioner: aluminium & stainless steel
- Attachment ends: swivel brass connector and stop knot
- Anchor type: forged alloy steel O-rings (x4)
- Max no. of users: 4 users
- Max span length: 5 to 25m
- Weight: 9.27kg ± 0.10kg

Conforms to: EN 795:2012 Type C & TS 16415 Type C

Product Codes

HS3001	4 Man Temporary Horizontal Rope Anchorage Line
--------	--

Note: When used at full extension, beware of bowing effect in middle of lifeline. Set anchor point heights to compensate. See Fall Clearance and Line Deflection Diagram on previous page.

2 Man temporary horizontal rope anchorage line - HS3002

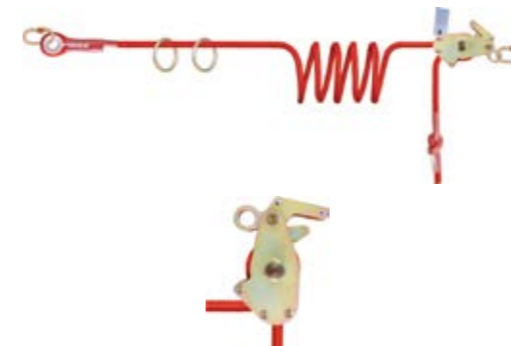

Features

- Rope type: kernmantle rope 16mm
- Tensioner: steel
- Attachment ends: stitched loop and stop knot
- Anchor type: forged alloy steel o-rings (x2)
- Max no. of users: 2 users
- Max span length: 5m to 25m
- Weight: 9.05kg ± 0.10kg

Conforms to: EN 795:2012 Type C & TS 16415 Type C

Product Codes

HS3002	2 Man Temporary Horizontal Rope Anchorage Line
--------	--

Note: When used at full extension, beware of bowing effect in middle of lifeline. Set anchor point heights to compensate. See Fall Clearance and Line Deflection Diagram on previous page.

Rescue kit



Features

This Rescue Kit is manufactured using approved components in QSi's factory which carries the AS/NZS ISO 9001:2008 certification. Kit Contains:

- 2 x Large Twin Pulleys (EN 12278 & CE certified: Rated 30kN)
- 1 x Swivel carabiner (EN 362:2004/B & CE certified: Rated 25kN)
- 1 x 50kN offset carabiner (EN 362:2004/B & CE certified: Rated 50kN)
- 1 x 23 kN alloy scaffold hook with wing on gate. Can be used with rescue pole for easy connection to casualty. (EN 362:2004/EN 12275)
- 11mm Kernmantle rope (AS/NZS 4142.3:1993 or EN 1891:1998)
- 1 x Rope control device attached to rope (EN 358:2000)
- 1 x Webbing Round Sling (UTS: 24kN)
- 1 x Delta Link (UTS: 30 kN)
- 1 x Rope Bag (100m or 200m)
- 1 x Rescue Pole

Product Codes

HSR012	12m Rescue Kit - 50m of rope
HSR025	25m Rescue Kit - 100m of rope
HSR035	35m Rescue Kit - 150m of rope
HSR050	50m Rescue Kit - 200m of rope

Pole top rescue kit



Features

This kit provides an ingeniously simple method of rescuing a worker who has fallen from their ladder and is suspended by their lanyard from a crossmember. Simply loop the rope over the cross member, loop it back around itself several times and clip the carabiner to the worker's harness chest loops. Once released from their lanyard, they can be lowered gently to the ground thanks to the friction of the rope looped around itself.

Product Codes

PTRK	Pole Top Rescue Kit - 20m of rope
------	-----------------------------------

Recommended harnesses to use with tripods



Product Codes

SBE3KQR	Full Body Harness. Confined Space. Loops Front Lower Loops & Back Anchorage Point. Q/R Buckles
SBEMT	Full Body Multitask Rescue Harness
SBEMT2	Colour Scopic Full Body Multitask Rescue Harness

Tripod with double pulley head - 7ft



Features

This double pulley tripod provides a robust, portable anchorage point, giving you access to confined spaces for personnel and materials.

Tripod specs and features include:

- Fully adjustable telescopic legs, adjustable height from 1.19m to 2.18m
- Multiple attachment points: two auxiliary eye bolts and mounted pulleys
- Support shoes with rubber soles improve grip and stability.
- Includes carry bag and in-built fixture for attaching the winch (can be removed on request).
- Cast aluminium head.
- Light weight, only 17.2kg.
- Footprint diameter (max): 1.5m internal and 1.86m external
- Strength of anchorage point: greater than 12kN.
- Maximum load capacity: 500kg

Certified to: EN795:2012 Type B

Product Codes

SRT1001DP	Tripod Double Overhead Pulley - 7ft
-----------	-------------------------------------

Tripod with double pulley head - 10ft



Features

This double pulley tripod provides a robust, portable anchorage point, giving you access to confined spaces for personnel and materials.

Tripod specs and features include:

- Fully adjustable telescopic legs, adjustable height from 1.76m to 2.72m
- Multiple attachment points: two auxiliary eye bolts and mounted pulleys
- Support shoes with rubber soles improve grip and stability.
- Includes carry bag and in-built fixture for attaching the winch (can be removed on request).
- Cast aluminium head.
- Weight: 21.8kg.
- Footprint diameter (max): 2.0m internal and 2.36m external
- Strength of anchorage point: greater than 12kN.
- Maximum load capacity: 500kg

Certified to: EN795:2012 Type B

Product Codes

SRT2001DP	Tripod Double Overhead Pulley - 10ft
-----------	--------------------------------------

Mounting brackets for winches and retrieval blocks



HS800 (44)

HS800 (45)

Product Codes

HS800(44)	Mounting Brackets for all Winches
HS800(45)	Mounting Brackets for Retrieval Blocks - 10m, 20m & 30m

SRW1001 winch

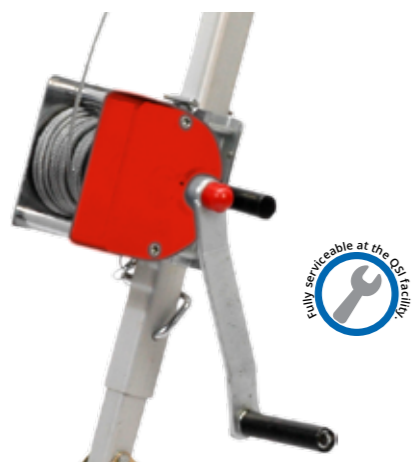

Features

Winch specs and features include:

- Bolting fixture for robust fitting to tripod
- Cable length: 20m
- Maximum lifting load capacity as per EN 1496: 135 kgs
- Maximum lifting load capacity as per machinery directive 2006/42/EC : 250 kgs

Certified to: EN 1496:2006 (Class A)

Product Codes

SRW1001	Winch
---------	-------

Note: QSi recommend a backup cable block be used with this winch when raising or lowering a person (see pg. 145 onwards).

30m retractable block with retrieval winch



Features

This innovative design combines the safety of a fall arrest system with the convenience of a retrieval winch, giving you one of the most versatile cable blocks on the market.

It operates just like our other cable blocks, allowing the user full vertical motion in both directions with the safety of a fall arrest system.

However, in the event of a fall, instead of having to fetch a separate winch to extract the victim, the built in winch allows you lift them to safety immediately.

As a rescue tool, it also enables a rescuer to descend safely to the victim to assess the situation. As a height safety tool, it allows a worker to access difficult spaces before being winched back up by his colleagues.

- A locking pin on casing allows the block to be easily switched between fall arrest and winch modes
- Can be mounted on the leg of a tripod using specialised bracket (not included)
- MBL: 12kN
- Weight: 14.8kg
- Length: 30m

Certified to: EN 360:2002 and EN 1496:2006 Class A

Product Codes

SRLS20R	20m Retractable Cable Block with Hoisting Winch
SRLS30R	30m Retractable Block with Retrieval Winch
HS800(44)	Mounting Brackets for all Winches
HS800(45)	Mounting Brackets for Retrieval Blocks - 10m, 20m & 30m

HS818 winch



Features

Comes with an independent reel mode for quick and easy installation of the Winch. HS818 is also equipped with a secondary brake mechanism which reduces the dynamic load impact felt on the user in the event of the fall, to less than 6kN.

To be used for raising or lowering of personnel or material into confined spaces.

- Equipped with mounting plate and four bolts for mounting to QSi Tripods and Davits
- Comes with 20m galvanized steel wire rope, 6mm diameter. Up to 40m length available on request
- Includes swivel steel snap hook as connector
- Maximum lifting load capacity as per EN 1496: 135 kgs
- Maximum lifting load capacity as per machinery directive 2006/42/EC : 250 kgs
- Conforms to EN 1496:2006 (Class B)
- To be used with retractable fall arrester when raising or lowering of person

Also available with stainless steel wire rope.

Product Codes

HS818	Winch
-------	-------

Spreader bar



Features

The Dynamic Confined Space Spreader Bar has specially designed attachments to be used on all standard shoulder straps for confined space rescue and retrieval with most of our harnesses.

Spreader Bar specs and features include:

- Snap Hooks attach directly to the shoulder straps of the harness. If required, the subject's arms can be raised above their head using the wrist straps.
- The attachment D-Ring connects to the retrieval system so the subject can be removed to safety.

Refer to AS/NZS 2865 for confined space procedures and practices as well as AZ/NZS 1891.4 for information on the selection, use and maintenance of fall arrest equipment.

Product Codes

DCSSB02	Dynamic Confined Space Spreader Bar
---------	-------------------------------------

Auto descender



Features

Our Auto Descender features automatic speed control thanks to a centrifugally controlled brake. The device keeps the speed constant for the entire descent run, enabling a swift and safe rescue. Speed remains the same irrespective of the person's weight.

Specifications:

- Max allowed descent height: 30m
- Max Load: 150kg
- Min Load: 20kg
- Descent speed: 0.80m - 1.50m/sec (depending on load)

Product Codes

AD003	Auto Descender with 30m of kernmantle rope
-------	--

Easy seat



Features

Attaches securely to the front attachment points of the harness for a more stable, comfortable seat while working at height.

Product Codes

EASYSEAT01 Clip On Seating Attachment

Rescue triangle



Features

To be used for rescue of injured personnel. Contains 3 metallic D-Rings at attachment points.

Product Codes

HS852 Evacuation Rescue Triangle

Adjustable webbing foot loop



Features

Attaches to ascenders and rope grabs to enable the user to climb a vertical rope.
44mm wide webbing with abrasion resistant shield.

Product Codes

HS402A Adjustable Webbing Foot Loop

Pilot chair



Features

Must be used in conjunction with Full Body Harness and Fall Arrest system.

- Ergonomic and comfortable working chair.
- For ascent and descent.

Certified to: EN1498

Product Codes

PILOTCHAIR Free hanging webbing chair

Extendable rescue pole



Features

Our Extendable Rescue Pole is designed to aid in the rescue of an individual suspended in a full body harness. The pole helps a rescuer to reach the individual, connect to their harness and move them to safety. Pictured with Aluminium Scaffold Hook MH007 attached (not included). Refer to pg. 195 for hook details.

Product Codes

RESCPOLE Extendable rescue pole

Basket stretchers and accessories

Basket Stretchers provide a more secure solution; their high sides and ends help keep your patient stable, especially when being transported in steep terrain, and they have special attachment points for winch, belay or helicopter rescues.

Basket stretcher



Features

- Sturdy attachment points for ropes and carabiners.
- Multiple hand grips around the edge of the stretcher.
- Four safety belts for securing patient.
- Adjustable foot plate.

Size: 219cm x 64cm x 18cm
Weight: 16kg | Max Load: 159kg

Product Codes

PARA37 Basket Stretcher

Break apart basket stretcher



Features

All the same great features of our standard basket stretcher but in a compact, break apart design for easy transport and storage.

Assembled size: 219cm x 64cm x 18cm
Disassembled size: 130cm x 67cm x 29cm
Weight: 16kg | Max Load: 159kg

Product Codes

PARA37A Break apart basket stretcher

Lifting bridle - adjustable legs



Features

Four-legged, adjustable lifting bridle designed to attach to stretchers and basket stretchers to help with safe extrication from difficult positions. (stretcher not included)

Product Codes

PARA91 Lifting bridle - adjustable legs

Rescue recovery stretcher



Features

The rescue recovery stretcher is an ultra-portable extremely flexible system. Ideal for search and rescue teams, it is particularly useful in situations where a fast recovery from difficult terrain is required.

- Inert to all conditions and body fluids
 - Rolls up for easy storage and carrying in a backpack
 - Extensive strapping to secure patient
- Weight: 8kg | Max Load: 200kg

Product Codes

PARA40R Rescue recovery stretcher

Q-Tech Shield Helmet

Choosing the right helmet:

When it comes to safety, it's important to pick the right gear for the job. Our Climbing and Rescue helmets feature a polystyrene liner designed to protect from multiple impacts, whereas our Industrial Safety helmets are built with a cradle liner designed to absorb shock.

Due to the inherent differences between these two systems, it is impossible to manufacture a single helmet that meets both standards. **Do not be misled by manufacturers who claim their helmets meet both standards.**

Product Features:

- Strong, light ABS plastic shell.
- Low-profile slots for clip-on hearing protection.
- Multiple clips hold head torch strap in place. (Torch not included.)
- Venting system allows a continuous flow of air across the head to keep the wearer cool and comfortable, while maintaining impact protection.
- Three-way adjustable nylon chin strap with robust, off-set clip.
- Headband ratchet wheel makes adjustment easy for a wide range of head sizes.

Available colours: White, Flouro Yellow, Orange, Red.
Note: Red only available as Industrial Safety Helmet.



Vented climbing and rescue helmet



Features

Fitted with a padded polystyrene liner designed to protect from multiple impacts. Visor attachment included.

Certified to: EN12492.

Product Codes

HELMETQTECHCW	Vented Climbing & Rescue Helmet - White
HELMETQTECHCFY	Vented Climbing & Rescue Helmet - Fluro Yellow
HELMETQTECHCO	Vented Climbing & Rescue Helmet - Orange

Vented industrial safety helmet



Features

Fitted with a dense rubber lining and cradle to absorb shock. Visor attachment included.

Certified to: EN397.

Product Codes

HELMETQTECHW	Vented Industrial Safety Helmet - White
HELMETQTECHFY	Vented Industrial Safety Helmet - Fluro Yellow
HELMETQTECHO	Vented Industrial Safety Helmet - Orange
HELMETQTECHR	Vented Industrial Safety Helmet - Red
HELMETQTECH-PAD	Replacement sweatband set for Qtech Industrial Helmet

Safety helmet visor kit



Features

Impact rated visor for eye protection. Clips up or down as required.

NOTE: Cannot be retrofitted to older helmets. Contact us for more information.

Product Codes

HELMETQTECHVIS	Visor for Q-Tech Helmets
HELMETQTECHVISMIR	Mirror/Tinted/Smokey Visor for Qtech Helmet

Safety helmet reflective sticker kit



Features

Reflective sticker kit suitable for all Q-Tech helmets.

Product Codes

HELMETQTECHREF	Reflective stickers for QTECH Helmet
----------------	--------------------------------------

Q-Tech Trooper Helmet

Hands and feet are valuable, but they are useless without a fully functional brain. Protect yours with a QTECH Trooper Helmet from QSi. The QTECH Trooper Helmet is a non-vented, light weight and comfortable helmet with a built-in chin strap. Electrical insulation rating to Class E, 20,000 volts. Suitable for Electrical Line Work.

Standards:

- Manufactured to: AS/NZS 1801:1997
- ANSI Z89.1:2014 Type 1 Class E LT
- CE EN 397:2012+A1:2012
- EN 50365:2002 Electrician Class O

Product Features:

- Short peak
- Foam sweatband
- Strong, light ABS plastic shell
- 6-point webbing suspension system
- Simple wheel adjustment to fit most workers
- 3-point nylon chin strap with quick release buckle
- Multiple clips hold head torch strap in place (torch not included)
- Slotted integration of wide range of accessories (earmuffs, faceshields, visors)

Available colours: White, Yellow, Orange, Blue & Red.



QTECH Trooper helmet



Features

Fitted with a padded polystyrene liner designed to protect from multiple impacts. Visor attachment included.

Certified to: EN12492.

Product Codes

QTECHTROOPW	Qtech Trooper Helmet with Visor Attachment White
QTECHTROOPY	Qtech Trooper Helmet with Visor Attachment Yellow
QTECHTROOPO	Qtech Trooper Helmet with Visor Attachment Orange
QTECHTROOPB	Qtech Trooper Helmet with Visor Attachment Blue
QTECHTROOPR	Qtech Trooper Helmet with Visor Attachment Red

QTECH Trooper helmet visor kit



Features

Impact rated visor for eye protection. Clips up or down as required.

NOTE: Cannot be retrofitted to older helmets. Contact us for more information.

Product Codes

QTECHTROOPVISORC	Qtech Trooper Helmet Visor Clear
QTECHTROOPVISORS	Qtech Trooper Helmet Visor Smoke

QTECH Trooper helmet FR chin strap



Product Codes

QTECHTROOPFRC	Qtech Trooper FR Chin Strap
---------------	-----------------------------

Pulleys and Swivels

Our light-weight pulleys are designed with portability in mind. They're made of lightweight alloy and employ a simple, bearing-free design.

Note: these pulleys are not designed for permanent installation or high-frequency use.

Large double pulley



Features

Features floating arms with top and bottom attachment points and 60mm sheave.

Max rope size: 16mm

Alloy | MBL: 30kN

CE Marked UIAA

Weight: 423g

Certified to: EN12278

Product Codes

MP2127	Large Double Pulley
--------	---------------------

Large single pulley



Features

Features floating arms with top and bottom attachment points and 60mm sheave.

Max rope size: 16mm

Alloy | MBL: 30kN

CE Marked UIAA

Weight: 246g

Certified to: EN12278

Product Codes

MP2128	Large Single Pulley
--------	---------------------

Small pulley - fixed sides



Features

Single 30mm sheave, fixed sides.

Max rope size: 13mm

Alloy | MBL: 22kN

CE Marked UIAA

Weight: 85g

Certified to: EN12278

Product Codes

MP2129	Small Pulley - Fixed Sides
--------	----------------------------

Small pulley - floating sides



Features

Single 30mm sheave, floating sides.

Max rope size: 11mm

Alloy | MBL: 20kN

CE Marked UIAA

Weight: 85g

Certified to: EN12278

Product Codes

MP2142	Small Pulley - Floating Sides
--------	-------------------------------

Small pulley - floating sides



Features

Single 30mm sheave, floating sides.

Max rope size: 11mm

Alloy | MBL: 20kN

CE Marked UIAA

Weight: 121g

Certified to: EN12278

Product Codes

MP2130	Small Pulley - Floating Sides
--------	-------------------------------

Inline twin pulley



Features

30mm sheave, fixed sides.

Max rope size: 13mm

Alloy

MBL: 24kN

CE Marked UIAA

Weight: 196g

Certified to: EN12278

Product Codes

MP2122	Inline Twin Pulley - 30mm Sheave Fixed Sides
--------	--

MP2122SS	Stainless Steel Inline Twin Pulley - 30mm Sheave Fixed Sides
----------	--

Alloy swivel



Features

MBL: 30kN

CE Marked

Certified to: EN354

Product Codes

MP2126	Alloy swivel
--------	--------------

Hooks

In addition to being EN certified, our steel hardware is also tested for sea salt spray requirements.

Triple action talon hooks

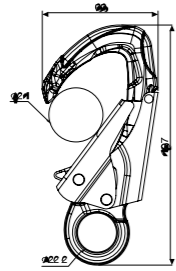

Features

Our triple-action Talon Hook™ is the latest evolution in snap hooks. The talon shape and wide gate opening means it clips on to a wider variety of attachment points, while still being compact and lightweight. MBL: 23kN | Weight: 214g

Certified to: EN362:2004/B | CE Marked

Product Codes

MH2632 Triple Action Talon Hook™

Double action offset alloy hooks

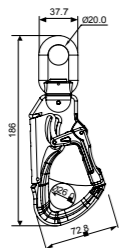

Features

When an excessive loading is placed on this hook, a load indicator will show red. This indicates that the unit must be removed from service. MBL: 25kN | Weight: 165g

Certified to: EN362:2004/T | CE Marked

Product Codes

MH2335AL Double Action Offset Alloy Hook

Standard double action snap hook - steel

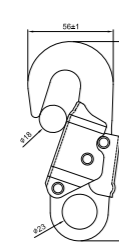

Features

Predominately used on the end of personal lanyards, etc. MBL: 25kN | Weight: 238g

Certified to: EN362:2004/A | CE Marked

Product Codes

MH003 Standard Double Action Snap Hook - steel

Swivel double action snap hook - steel

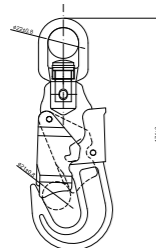

Features

Predominately used on the end of personal lanyards and ropes, etc. This unit swivels which reduces kinking. Features a built in load indicator. MBL: 23kN | Weight: 356g

Certified to: EN362:2004/A | CE Marked

Product Codes

MH006 Swivel Double Action Snap Hook - steel

Flat back double action snap hook - steel

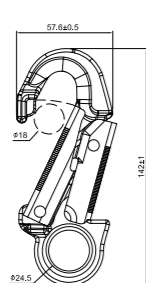

Features

Predominately used on the end of personal lanyards and ropes etc. Has a flat back to lower the risk of self opening when leaning up against something. Glove-friendly. MBL: 25kN | Weight: 287g

Certified to: EN362:2004/A | CE Marked

Product Codes

MH009 Flat Back Double Action Snap Hook - steel

Aluminium rebar hook



Features

Lightweight rebar hook with a 60mm gate opening. MBL: 23kN | CE Marked | Weight: 475g

Certified to: EN362:2004/T

Product Codes

MH011 Aluminium Rebar Hook

Giant double action hook

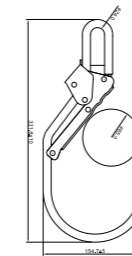

Features

Large gate opening for use on electric pylons. MBL: 18kN | CE Marked | Weight: 860g

Certified to: EN362:2004/A

Product Codes

MH005 Giant Double Action Hook

Giant alloy hook

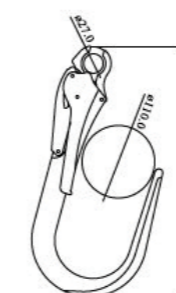

Features

Ideal for Tower work due to its large gate opening of 110mm. MBL: 23kN | CE Marked | Weight: 925g

Certified to: EN362:2004/A

Product Codes

MH2084A Giant Alloy Hook

Double action scaffold hook - steel

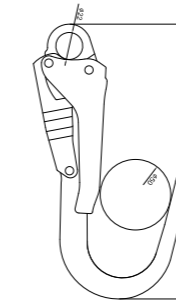

Features

Predominately used on the end of personal lanyards and ropes for securing to scaffolding.

MBL: 25kN | CE Marked | Weight: 514g

Certified to: EN362:2004/A

Product Codes

MH004 Scaffold Hook - Double Action - Steel

Double action scaffold hook - alloy

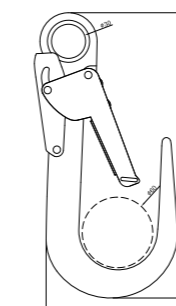

Features

Predominately used on the end of personal lanyards and ropes for securing to scaffolding.

MBL: 22kN | CE Marked | Weight: 471g

Certified to: EN362:2004/A

Product Codes

MH007 Scaffold Hook Double Action - alloy

Carabiners

Our range of carabiners are available in a number of metals with many gate-closing options and kN strengths.

Oval carabiner - steel, screw gate

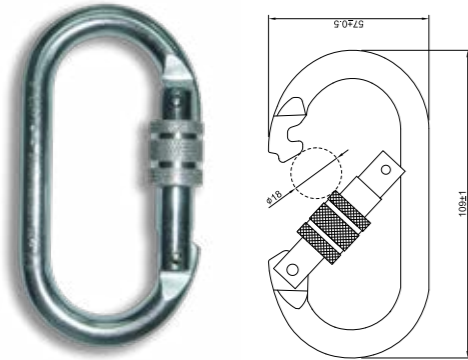

Features
Oval shape.
MBL: 25kN | Weight: 165g
Certified to: EN362:2004/B | CE Marked

Product Codes
MC001 Oval Carabiner - Steel, Screw Gate

Offset carabiner - steel, triple locking

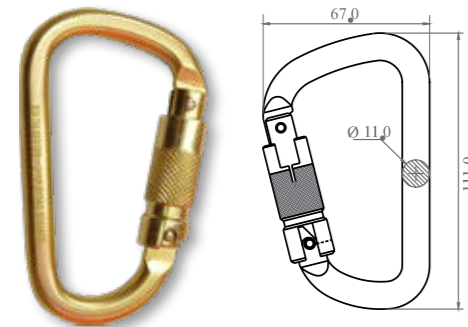

Features
Offset shape.
MBL: 25kN | Weight: 196g
Certified to: EN362:2004/B | CE Marked

Product Codes
MC002K Offset Carabiner - Steel, Triple Locking

Offset carabiner - steel, triple locking, with Captive Eye Pin

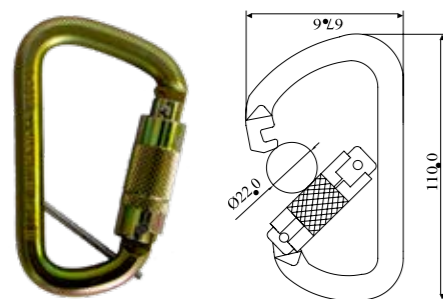

Features
Offset shape.
MBL: 30kN
Weight: 236g
Certified to: EN362:2004/B | CE Marked

Product Codes
MC002KCE Offset Carabiner - Steel, Triple Locking

D-Shape carabiner - steel, 10mm twist lock

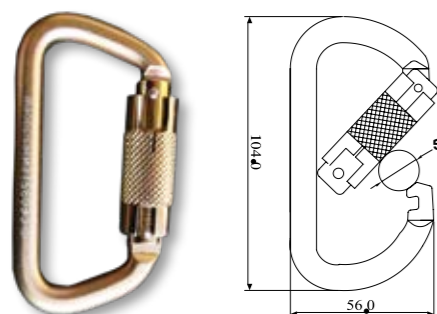

Features
D-shape.
MBL: 40kN
Weight: 195g
Certified to: EN362:2004/B | CE Marked

Product Codes
MC015 D-Shape Carabiner - Steel, 10mm Twist Lock

Offset carabiner - steel, screw gate

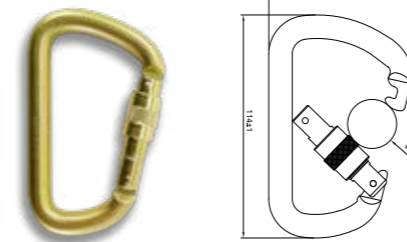

Features
Offset shape.
MBL: 50kN | Weight: 251g
Certified to: EN362:2004/B | CE Marked

Product Codes
MC003 Offset Carabiner - Steel, Screw Gate

Offset carabiner - steel, triple locking

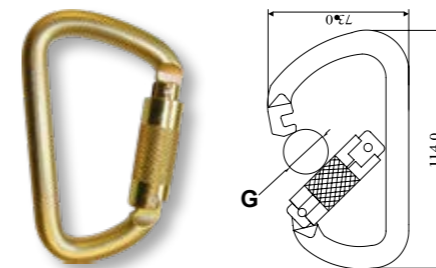

Features
Offset shape.
MBL: 50kN | Weight: 256g
Certified to: EN362:2004/B | CE Marked

Product Codes
MC004 Offset Carabiner - Steel, Triple locking

Offset carabiner - steel, triple locking, with captive eye pin



Features
Screw Gate. Offset shape. Comes with captive eye pin.
MBL: 40kN | Weight: 256g
Certified to: EN362:2004/B | CE Marked

Product Codes
MC050 Offset Carabiner - 50kN Steel Triple Locking w/ Captive Eye Pin

Large rescue carabiner - steel, screw gate, with captive eye pin

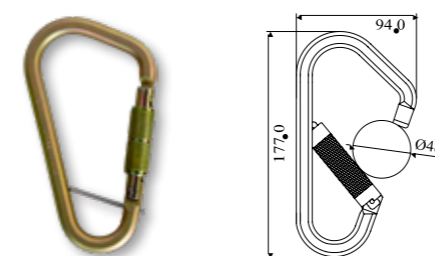

Features
Screw Gate. Offset shape. Comes with captive eye pin.
MBL: 40kN | Weight: 256g
Certified to: EN362:2004/B | CE Marked

Product Codes
MC009 Large Rescue Carabiner - Steel Screw Gate

Carabiner - stainless steel

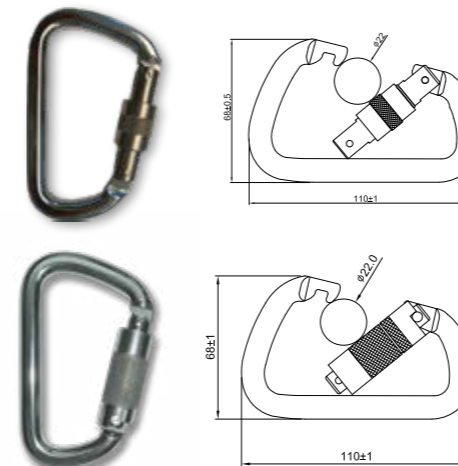

Features
Renown for its longevity in corrosive, heavy-weather, outdoor environments.
Available in two clip styles: Screw gate and triple locking. Offset shape.
MBL: 41kN | Weight: Screw Gate: 215g | Triple Locking: 232g
Certified to: EN362:2004/B | CE Marked

Product Codes
MC005 Carabiner - Stainless Steel, Screw Gate
MC006 Carabiner - Stainless Steel, Triple Locking

Carabiner - alloy, side swing gate

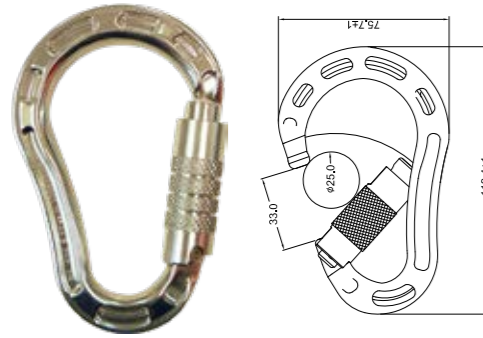

Features

Lightweight, strong alloy carabiners are perfect for situations where weight and portability is essential. Available in three clip styles: Triple locking, screw gate and twist lock. Offset shape. MBL: 22kN Weight: 93g

Certified to: EN362:2004/B | CE Marked

Product Codes

MC008TRIPL	Carabiner - Alloy, Side Swing Gate - Triple Locking
------------	---

Offset carabiner - alloy, screw gate

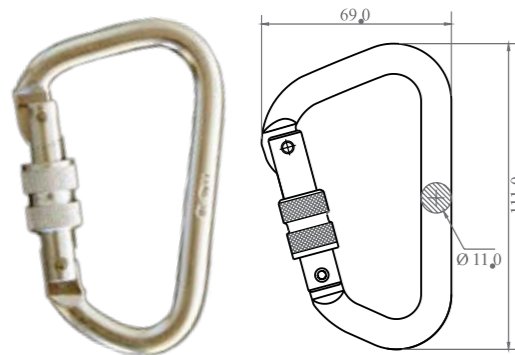

Features

Offset shape. MBL: 24kN Weight: 77g Certified to: EN362:2004/B | CE Marked

Product Codes

MC016	Offset Carabiner - Alloy, Screw Gate
-------	--------------------------------------

Oval delta quick link - 8mm, steel

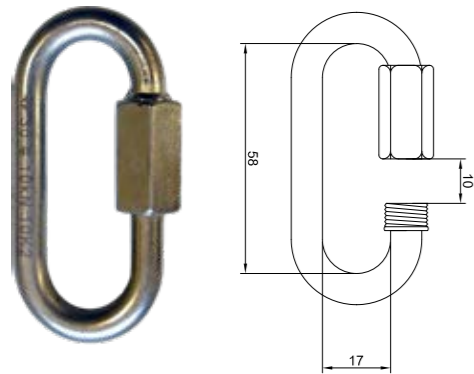

Features

Quick Links are a semi-permanent option to quickly join safety items together. A crescent should be used to achieve optimal security. MBL: 30kN CE Marked UIAA. Certified to: EN362:2004/Q | CE Marked

Product Codes

MC012	Oval Delta Quick Link - 8mm
-------	-----------------------------

Triangular delta quick link - 8mm, steel

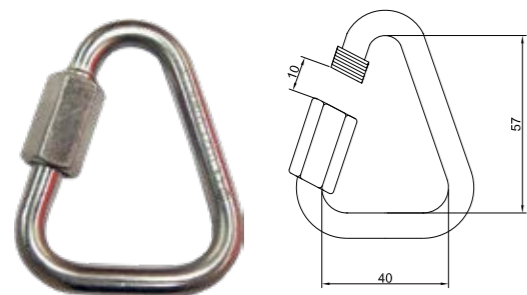

Features

Quick Links are a semi-permanent option to quickly join safety items together. A crescent should be used to achieve optimal security. MBL: 25kN CE Marked UIAA. Certified to: EN362:2004/Q | CE Marked

Product Codes

MC013	Triangular Delta Quick Link - 8mm
-------	-----------------------------------

Material Handling Webbing Straps

Material Handling Webbing Straps are an ideal aid for carrying heavy objects. The webbing sling keeps the user's hands away from the heavy object, helping to prevent accidental slippage and avoid potential injury when lowering. The different lengths of sling allow for ergonomic lifting techniques by enabling the load to be carried in an upright standing position, removing the need for bending and awkward twisting.

Material handling webbing straps



MATERIAL HANDLING STRAP HANDLE



MATERIAL HANDLING STRAP - 700MM



MATERIAL HANDLING STRAP - 1M



ADJUSTABLE MATERIAL HANDLING STRAP - 1.2M

Features

Material Handling Straps have a Maximum Break Load rating of 12kN. Material Handling Strap Handles have a Maximum Break Load rating of 500kg.

Product Codes

MHSH	Material Handling Strap Handle
MHS07	Material Handling Strap - 700mm
MHS10	Material Handling Strap - 1m
MHSA12	Adjustable Material Handling Strap - 1.2m

Directions for use:



1. Place webbing sling around object.
2. Feed metal ring through webbing loop.
3. Clip metal ring into hook on lifting handle.
4. Lift object. If load is heavy, add extra strap and have two people carry it.

Push / pull pole



Features

Our robust Push/Pull Pole has been designed to aid in the handling of cargo containers when loading and unloading on land or sea. It allows the user to safely push cargo containers away from them or pull netting, ropes, cables and containers towards them. This pole can also be used for retrieval of identification tags from containers.

This tool helps keep the user at a safe distance, to prevent crushing or pinching of hands and feet. **The heavy duty fibreglass pole and robust nylon head make a super strong tool capable of holding up to 250Kg.**

Product Codes

SPPUSHPULL1.0	1.0 Meter Push/Pull Pole with Handle
SPPUSHPULL1.3	1.3 Meter Push/Pull Pole with Handle
SPPUSHPULL1.8	1.8 Meter Push/Pull Pole with Handle

Pipe push pole



Features

This phenomenal tool is designed for the rigours of the oil rig where physical abuse and corrosive substances are the norm and your life can depend on the quality of your equipment. Designed for pushing of drill rig pipes.

- Machined, corrosion resistant, high strength plastic head
- **Max load: 250kg**

Product Codes

SPIPEPUSH1.0	1.0m Meter Pipe Push pole with handle
SPIPEPUSH1.3	1.3m Meter Pipe Push pole with handle
SPIPEPUSH1.8	1.8m Meter Pipe Push pole with handle

Catch-it pole

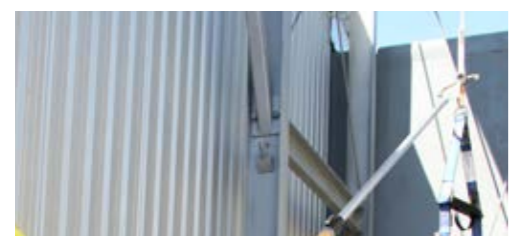

Features

The Catch-It Pole is a lightweight, extendable pole with a large hook designed for grabbing and moving ropes, cables and lanyards.

- Pole can be extended from 1.2m to 2.1m in 150mm increments.
- Hook dimensions: 250mm x 150mm

Product Codes

CATCHIT	1.2m - 2.1m Extendable Catch-It Pole
---------	--------------------------------------

1.4m pipe handling pole



Features

This phenomenal tool is designed for the rigours of the oil rig where physical abuse and corrosive substances are the norm and your life can depend on the quality of your equipment. Features include:

- Machined, corrosion resistant, high strength plastic head
- Flexible plastic nubs on the head provide extra grip on pipes.
- **Max load: 250kg**

Product Codes

SPIPHAN1.1	1.1m Pipe Handling Pole
SPIPHAN1.4	1.4m Pipe Handling Pole
SPIPHAN1.9	1.9m Pipe Handling Pole



Vertex HS8000 Vertical Anchorage Line System on Rigid Aluminium Rail

This vertical fall arrest anchorage system (Conforming to EN 353-1) is an integrated solution made up of a vertical aluminium guide rail over which glides a guided-type fall arrest trolley.

The line is constructed by attaching the 3m lengths of rail in series using a junction to connect them, and clamps to attach them to the ladder rungs. The trolley moves up and down on the line accompanying the user who is connected to it with an auto-locking steel carabiner.

In the event of a fall, the trolley immediately locks on the rail, thus arresting the fall. Also, while not in use, the unidirectional locking system of the trolley prevents it from sliding down on its own.

The rail comes with an extension arm that curves at the top of the ladder, over the working platform. This allows the climber to be connected to the trolley even at the ladder termination, ensuring complete safety.

The bottom section of the aluminium rail extremity is equipped with a trolley lock that prevents the trolley from moving out of the rail (see figure below).

Certified to: EN353-1:2002

Fall protection for:

- Industrial ladders.
- Chimney ladders.
- Telecommunication towers.
- Power transmission towers.
- Windmills.
- Cranes.
- Shafts and manholes.
- Petrochemical plants, on-shore and off-shore oil rigs.

Product Codes

HS8000	Vertical Anchorage Line System on Rigid Aluminium Rail
--------	--

Component List:

1	Extension	HS8000 (02)	Material: Extruded aluminium alloy Length: 1.5m
2	Rail	HS5000 (01)	Material: Extruded aluminium alloy Length: 3m
3	Vertical Trolley	HS8000 (01)	Material: Stainless Steel (316) Trolley with brass wheel which provides frictionless movement.
4	Carabiner	HS111	Quarter turn auto-locking steel carabiner
5	Rung Clamp	HS8000 (03)	Material: Stainless Steel 316 Attaches the system onto the underlying ladder
6	Junction	HS5000 (08)	Material: Stainless Steel 316 Used to connect two rails together.
7	Rail Extremity	HS5000 (02)	Material: Extruded aluminium alloy Length: 3m

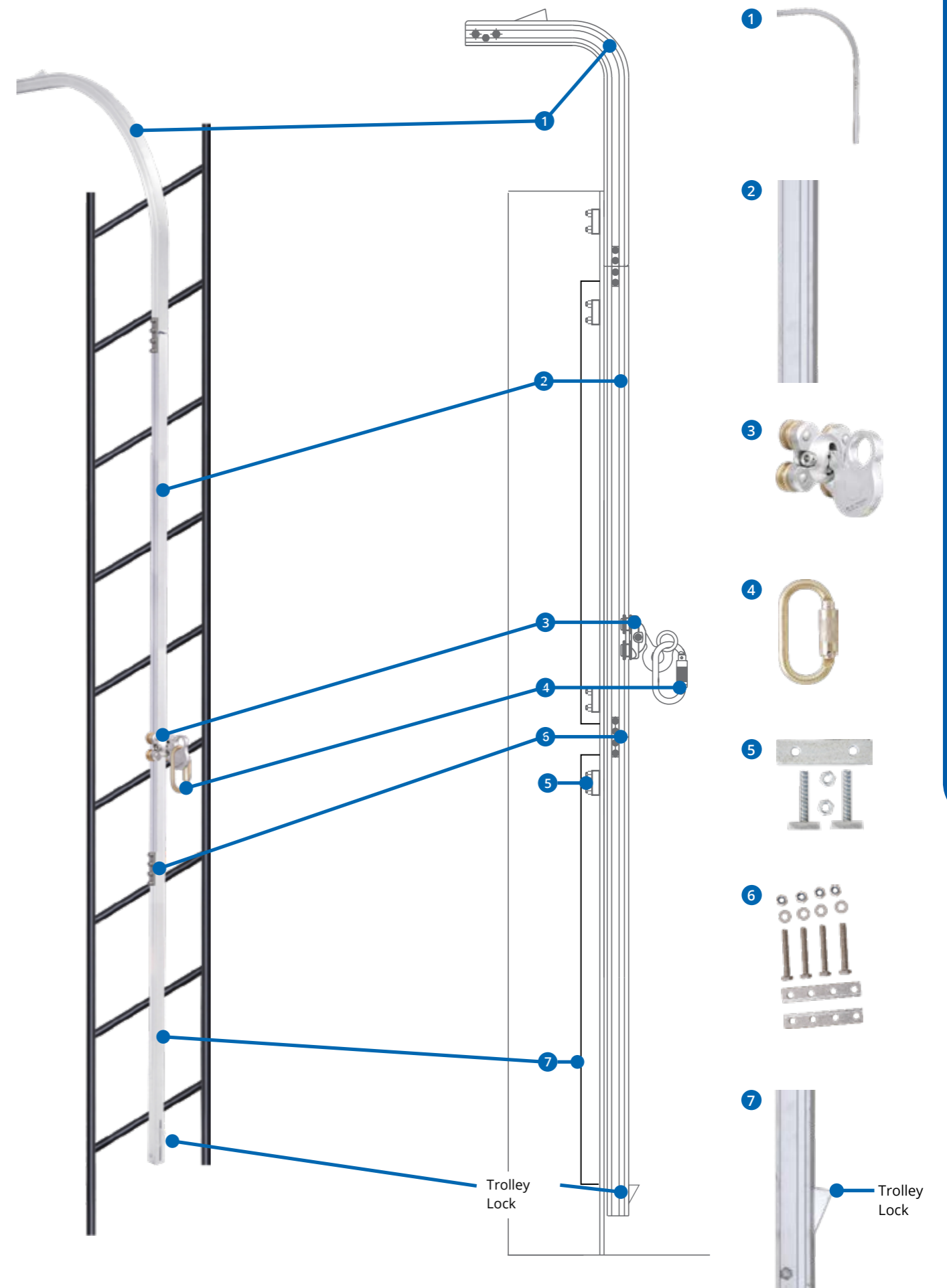

Vertex HS7000 Vertical Anchorage Line System on Rigid Cable Line

The Vertex HS7000 vertical anchorage line protects the user from a fall while ascending or descending a ladder. The unique feature of this system is a permanent installed stainless steel shock absorber at the top of the line. This offers distinct advantages over the textile absorbers used in other lines in terms of UV degradation and resistance to harsh climatic conditions.

The Vertical Anchorage Line is made of Stainless Steel wire rope. It is held in a rigid position by use of 2 mounting brackets—one at the top and one at the bottom.

The Stainless-steel Rope Grab is directly connected to the user without an additional lanyard.

To maintain the rigidity and high tension in the anchorage line, a screw type mechanical tensioner is provided at the end of the anchorage line at the bottom, connecting it to the lower mounting bracket.

The system is available in five sizes for ladders from 10m to 50m in height.

Also available is an optional Extension Arm to extend the system above the platform for safe disengagement of Fall Arrester from the system while standing on the platform.

Certified to: EN353-1:2002

Fall protection for:

- Industrial ladders.
- Chimney ladders.
- Telecommunication towers.
- Power transmission towers.
- Windmills.

Features and benefits:

- MOC: Stainless steel grade 316.
- Shock absorber reduces impact of fall on user as well as receiving structure.
- Suitable for 1 person.
- Intermediate cable guides every ten metres to reduce vibrations caused by wind pressure.
- Trained installers and engineers to install the system.

Product Codes

HS7000	(10m) Vertical Anchorage Line System for 10m ladder
HS7000	(20m) Vertical Anchorage Line System for 20m ladder
HS7000	(30m) Vertical Anchorage Line System for 30m ladder
HS7000	(40m) Vertical Anchorage Line System for 40m ladder
HS7000	(50m) Vertical Anchorage Line System for 50m ladder
EXTENSIONARM	Line System Extension Arm

Component List:

Qty	Component	Code	Material	Notes
2	Mounting Bracket	HS7000 (01)	Material: Stainless Steel 316	Breaking Strength > 23 kN Complies with EN 795 Class A1
1	Shock Absorber	HS7000 (02)	Material: Stainless Steel 316	Limits the impact of force in the event of fall to less than 6 kNm
1	Cable Extremity	HS7000 (03)	Swage Mechanism Material: Stainless Steel 316	
1	Wire Rope	HS9[length]SL	Material: Stainless Steel 316	Diameter: 8mm Construction: 7x19
1	Rope Grab	RG-02112	Material: Stainless Steel 316	Works on stainless steel wire rope.
4	Intermediate	HS2001 (04)	Material: Stainless Steel 316	Recommended Installation: every 10m
2	Wire Rope Cap	HS7000 (12)	Material: Aluminium Alloy	
1 Set	Set of U-Bolts and Thimbles	HS6000 (01)	Material: Stainless Steel 316 Material: Galvanized Steel	U - Bolts Qty: 2. Thimbles: Qty: 1
1	Tensioner	HS7000 (05)	Material: Stainless Steel 316	Regulates tensioning of the cable.

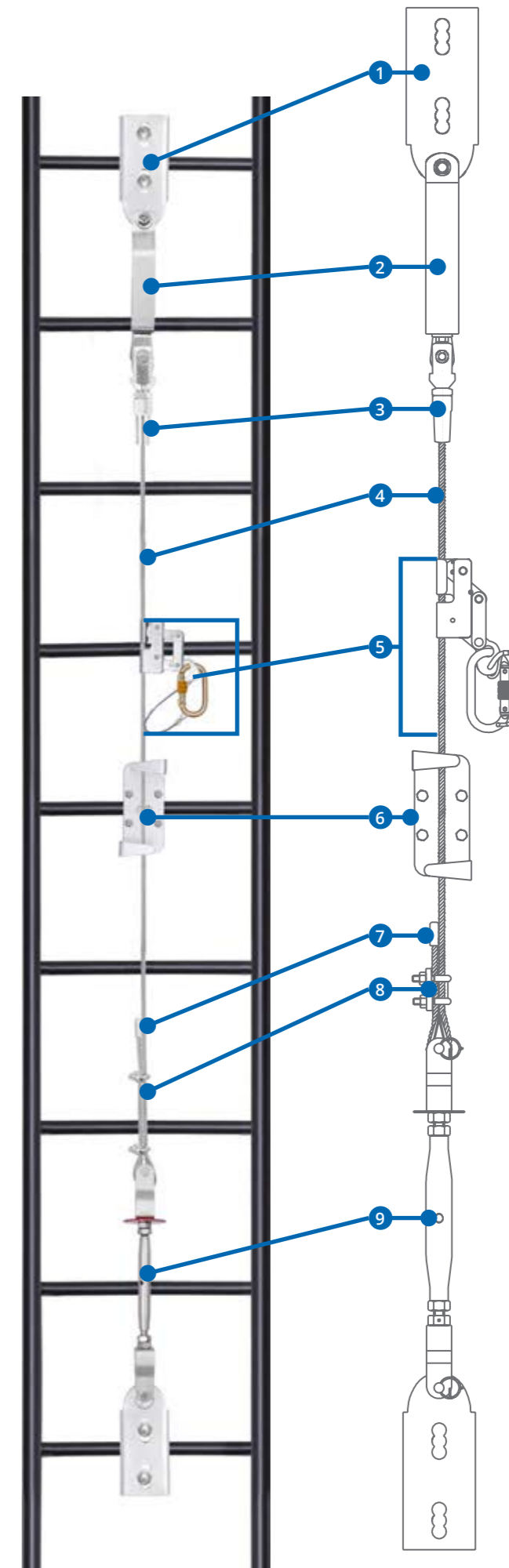
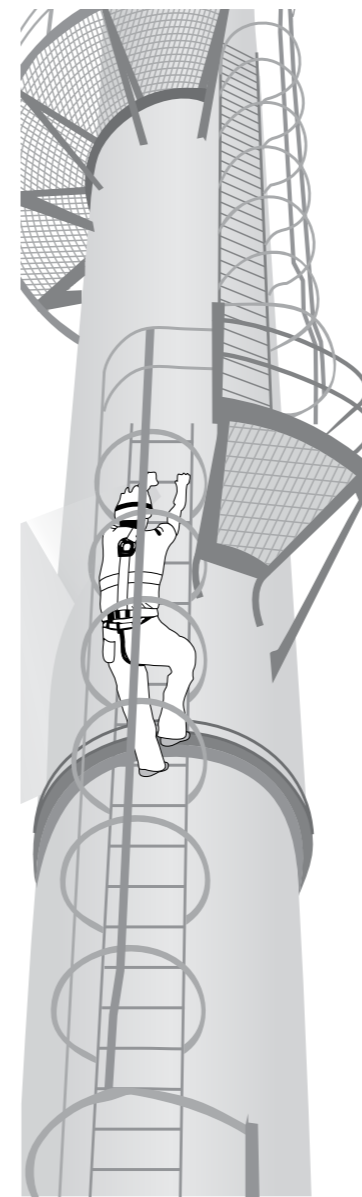

Vertex hs9000 industrial fall protection ladder



Features

The Vertex HS9000 is an integrated ladder and fall protection system. The low-profile design can be mounted on many structures to allow safe, easy access to high areas.

Certified to: EN353-1:2002

Fall protection for:

- Buildings
- Chimneys
- Wind Turbine Towers
- Transmission Towers
- Advertising Billboards.

Features and benefits:

- Continuous ladder with fall protection can negotiate bends.
- Corrosion free anodized aluminium rail.
- Hot-dipped galvanized rungs.
- Four-wheel trolley slides freely on the central rail and locks in place in the event of a fall.
- Assists in climbing. The unique design of trolley supports the user while ascending or descending.
- Locking jibs at either end to prevent unintentional release of trolley from the rail while in use.
- Aluminium rail extension to safely remove the trolley after reaching the landing platform.

Product Codes

HS9000	Vertex Fall Protection Ladder System
--------	--------------------------------------

Component Ref. # Description

HS8000(02)	Aluminium Extensions
HS5000(01)	Aluminium Rail Intermediate
HS8000(01)	Vertical Trolley
HS111	Carabiner
HS5000(06)	Mounting Bracket
HS5000(08)	Junction
HS5000(02)	Aluminium Rail Extremity
HS9000(01)	Ladder Rung Assembly
HS5000(03)	Mounting Nut



Davit arm system



Features

QSi introduces the new Davit Arm which provides a safe and secure system for easy access to confined spaces. The Davit Arm is an ideal choice to provide overhead anchorage which can be mounted on different bases and it conforms to EN 795:2012 Type A.

The Davit Arm is made of highly corrosion resistant stainless steel, and can swivel a complete 360 degrees on its mounted base, hence providing a versatile reach and access.

A unique feature is the adjustable height of the cantilever arm at 3 defined points, with upper arm position of 2.3m, middle arm position of 1.9m, and lowered arm position at 1.5m. This enables the use of the Davit Arm even in those areas where the roof height is small.

The Davit Arm can be easily mounted on the floor as well as on the wall through special floor and wall mounting brackets which are available as required. The Davit Arm can also be mounted on the floor of heavy vehicles, making it extremely versatile.

QSi Winch HS 818 and SRW1001 can be easily mounted on to the Davit Arm with the help of stainless steel fasteners.

Retrieval Fall Arrester Blocks (SRLS10R, SRLS20R and SRLS30R) can also be installed for easy retrieval & arresting the fall of the user using the specialized mounting brackets; Ref. HS900(06), HS900(07) & HS900(08) respectively.

Product Codes

HS900	Davit Arm System
HS900(01)	Floor Mounting Bracket
HS900(02)	Wall Mounting Bracket
HS900(06)	Mounting bracket for 30m Retrieval Block SRLS30R
HS900(07)	Mounting bracket for 20m Retrieval Block SRLS20R
HS900(08)	Mounting bracket for 10m Retrieval Block SRLS10R

Tool Lanyards

When working at height, you want to be sure your tools are as safe and secure as you are. QSI manufacture a range of tool lanyards, pouches and belts designed to keep your tools close at hand and safe from the risk of being dropped.

Belt lanyard - TKLDR



Product Codes

TKLDR 76cm Tool Lanyard with D-Ring

Belt lanyard - TKLTA



Product Codes

TKLTA 100cm Tool Lanyard with Tool Attachment

Belt lanyard - TKLETA



Product Codes

TKLETA 73cm Elasticated Tool Lanyard with Tool Attachment

Belt lanyard - TKLETAQR



Product Codes

TKLETAQR 86cm Elasticated Tool Lanyard with QR Tool Attachment

Belt lanyard - TKTA



Product Codes

TKTA 22cm Tool attachment for lanyard

Tool lanyard - TKLESSGC



Product Codes

TKLESSGC Orange Aluminium Elasticated Lanyard with Gate Carabiner - 127cm (SWL 5kg)

Tool lanyard - TKLCAU



Product Codes

TKLCAU Orange Aluminium Elasticated Lanyard with Swivel Twist Lock Hooks - 197cm (SWL 10kg)

Retractable tool lanyard - HS017S



Product Codes

HS017S Retractable 1.5m wire cable with protective coating. Suitable for tools weighing up to 5kg

Wrist Straps

Wrist strap - TKWSV



Product Codes

TKWSV 19cm Wrist Strap With Velcro

Wrist strap - TKWSQR



Product Codes

TKWSQR 19cm Wrist Strap With Quick Release Buckle

Wrist strap - TKWSE



Product Codes

TKWSE 19cm Elasticated Wrist Strap

Wrist strap - SBLTLW



Product Codes

SBLTLW 100cm Wrist Strap Attached to Lanyard



Belt loops

Belt loop - TKBLSIN



Product Codes

TKBLSIN Fixed Belt Loop with Single D-Ring

Belt loop - TKBLDBL



Product Codes

TKBLDBL Fixed Belt Loop with Double D-Ring

Belt loop - TKBLSINV



Product Codes

TKBLSINV Velcro Release Belt Loop with Single D-Ring

Belt loop - TKBLDBV



Product Codes

TKBLDBV Velcro Release Belt Loop with Double D-Ring

Tool belts - TKBB



Product Codes

TKBB Tool Belt Black

Tool belts - TKBLSINGR



Product Codes

TKBLSINGR Quick Release Belt Clip with Single D-Ring

Tool belts - TKBP



Product Codes

TKBP Tool Belt Back Pad

Tool belts - TKBBL



Product Codes

TKBBL Tool Belt Blue with Reflective Strip

Tool bags

Tool bag - TKBAG



Product Codes

TKBAG PVC Round Tool Bag

Tool bag - SBELTP



Product Codes

SBELTP Leather Tool Pouch

Tool bag - TKPPVC



Product Codes

TKPPVC PVC Tool Carry Pouch with Pockets



Restraint systems explained

While the primary focus of height safety in Australia and New Zealand is Fall Arrest, it is also important to consider the role of Restraint products. First, we need to understand the differences:

	Fall Arrest	Restraint
Products	Designed to safely absorb forces and prevent serious injury in the event of a fall.	Designed to restrict a worker's movement so there is zero risk of fall.
Worker	Free to move around their work space. Responsible for preventing themselves from falling.	Restricted to a very specific work space. Can rely on equipment to prevent them from falling.
Standards	Complies with AS/NZS Standards	Does not comply with AS/NZS Standards

While there are no AS/NZS standards covering restraint products, we apply the same tests to them as we do our fall arrest products. For example, we static load the attachment points with 15kN for three minutes just as we would for any product that meets the 1891.1:2007 standard.

Restraint products are necessary in some work situations where a worker must operate in a position that would be too dangerous to rely solely on a fall arrest system. Examples include:

- Working in a fixed position on a gantry or other platform at height.
- Working from a trailer or moving vehicle.

The key phrase to keep in mind is Zero Fall Risk. Restraint products are only used correctly when they guarantee there is no risk of fall whatsoever.

QSI recommends you use a full body harness and fall arrest system as a backup to your restraint system. In other words, set up your work environment with suitable fall arrest equipment, then add a restraint system to restrict movement and prevent a fall. It is your responsibility to perform a full risk assessment of your situation to ascertain whether a fall arrest system is required.



Chest restraint harness



Features

This harness includes a dorsal D-ring for restraint attachment with easy adjustment of the shoulder straps and a Quick Release Buckle.

- MBL: 15kN

NOT TO BE USED FOR FALL ARREST.

Product Codes

CHESHAR001	Chest Restraint Harness
------------	-------------------------

SMALL & 3XL+
sizes available on request

Restraint waist belt



Features

A simple, adjustable restraint Waist Belt with a Quick Release Buckle and rear D-ring for restraint attachment.

- MBL: 15kN

NOT TO BE USED FOR FALL ARREST.

Product Codes

SBERB04	Restraint Waist Belt
---------	----------------------

SMALL & 3XL+
sizes available on request

Adjustable restraint lanyard



Features

Our adjustable restraint lanyards are available in various lengths, and a variety of double and triple action hooks.

NOT TO BE USED FOR FALL ARREST.

Product Codes

SBLR11	1m Adjustable Restraint Lanyard
SBLR01	1.5m Adjustable Restraint Lanyard
SBLR10	2m Adjustable Restraint Lanyard

Adjustable restraint lanyard with scaffold hook



Features

Our adjustable restraint lanyards are available in various lengths, and a variety of double and triple action hooks.

NOT TO BE USED FOR FALL ARREST.

Product Codes

SBLR02	0.9m Adjustable Restraint Lanyard
SBLR03	1.2m Adjustable Restraint Lanyard
SBLR04	1.5m Adjustable Restraint Lanyard
SBLR05	2m Adjustable Restraint Lanyard

Paint tin carry belt



Features

A padded waist belt with Quick Release Buckle and D-ring attachment points at both hips.

- MBL: 15kN

NOT TO BE USED FOR FALL ARREST.

Product Codes

SBERB-PB Paint Tin Carry Belt

SMALL & 3XL+
sizes available on request

Padded restraint waist belt



Features

Padded restraint waist belt for extra comfort, with Quick Release Buckle and rear D-ring.

- MBL: 15kN

NOT TO BE USED FOR FALL ARREST.

Product Codes

SBERBQR Padded Restraint Waist Belt

SMALL & 3XL+
sizes available on request

Padded restraint belt with shoulder straps and rigging d-ring



Features

Padded restraint belt with rigging D-ring, one side D-ring, Quick Release Buckle on waist and reflective tape on shoulder straps and back of belt. The shoulder and chest straps help spread the load across the body for increased comfort and stability.

- MBL: 15kN

NOT TO BE USED FOR FALL ARREST.

Product Codes

SBERESTRAINT Padded Restraint Belt with Shoulder Straps and Rigging D-ring

SMALL & 3XL+
sizes available on request

Padded restraint belt with shoulder straps, fluro triangle and dorsal d-ring



Features

Padded restraint belt with dorsal D-ring and D-rings at both hips. Quick Release Buckles on waist and chest, reflective tape on shoulder straps and back of belt, and fluro triangle panel at rear.

- MBL: 15kN

NOT TO BE USED FOR FALL ARREST.

Product Codes

SBERESTRAINT2 Padded Restraint Belt with Shoulder Straps, Fluro Triangle and Dorsal D-ring

SMALL & 3XL+
sizes available on request

PVC Harnesses

Our range of PVC harnesses and other height safety equipment is designed primarily for the food and paint industries. As well as meeting the appropriate safety standards, the PVC webbing material offers some special benefits:

- Resistant to acids, blood and fat
- Easy to clean
- Industry-appropriate colour

PVC full body harness



Features

Our Full Body Harness with PVC coated webbing features two attachment webbing loops and a dorsal attachment D-Ring for fall-arrest. The sternal attachment points are particularly suitable for use with rope or cable grabs and offer a comfortable position to work from as well as for rescue.

High strength, easy adjustment webbing buckles are used on both legs and chest. Other features include easy-grip shoulder adjustment buckles, webbing fall arrest loops and high strength stitch pattern.

The SBE2PVC is AS/NZS 1891.1:2007 certified. It is available in sizes 3XL and above for use in conjunction with a 150kg rated block. See pg.<?> for more information.

Certified to: AS/NZS 1891.1:2007

Optional Extras

- D-Ring Extension Strap
- X-Factor Shoulder Padding System
- AirTech Breathable Padding System (see pg. 129)
- Heavy Duty PVC Bags, Backpacks, etc (see pg. 156)
- Tool Lanyards and Pouches (see pg. 208)

Product Codes

SBE2PVC	PVC Full Body Harness with Quick Release Buckles
----------------	--

SMALL & 3XL+
sizes available on request



PVC chest restraint harness



Features

This harness includes a dorsal D-ring for restraint attachment with easy adjustment of the chest and shoulder straps and Quick Release Buckle.

- MBL: 15kN

NOT TO BE USED FOR FALL ARREST.

Product Codes

CHESHAR002	White PVC Chest Restraint Harness with Quick Release Chest Strap
-------------------	--



SMALL & 3XL+
sizes available on request

PVC webbing restraint harness



Features

A simple, adjustable restraint waist belt with Quick Release Buckle and rear D-ring for restraint attachment.

- MBL: 15kN

NOT TO BE USED FOR FALL ARREST.

Product Codes

SBERB03PVC	PVC Webbing Restraint Belt
-------------------	----------------------------



SMALL & 3XL+
sizes available on request



premium
industrial clothing

Why choose QSi Premium Industrial Clothing?

We have been leading and innovating garments in various industries throughout the world's markets, from electric arc, petrochemical, mining and all other large and small businesses.

It is QSi's attention to detail, and listening to our customer's needs that are helping us innovate and stay current with market trends.

Linking this ability, and having world-leading raw material manufacturers supplying tried and tested fabrics, we offer a large range of products to meet our customer's individual needs.

With in-house manufacturing capabilities and partnerships with overseas suppliers, no problem is too big or too small for us to help with.

Talk to one of our sales specialists today to see how we can help you.



Road worker 100% cotton overalls

IRON WEAR



Features

QSi's IronWear range of 100% cotton overalls are built tough without sacrificing comfort. The Road Worker is designed for workers in high visibility situations, while also suitable for most other rugged work environments.

- Standards Compliant orange and blue colour scheme
- TTMC-W transit compliant reflective tape front and back
- Adjustable velcro wrist straps
- 280gsm 100% cotton
- Double-layer knees and seat
- Large, rugged front zip, easy to use while wearing gloves
- Breast pockets with velcro flaps
- Hip pockets
- Pen pocket
- Ruler pocket
- Hip access to inner garments
- Size range: 4 - 15
- Screen printing and monogramming of name, company logo, etc also available

Product Codes

OAIWCOTTMC_ 100% Cotton Overall 280gsm

IRON WEAR

IronWear 100% cotton overalls



Features

QSi's IronWear range of 100% cotton overalls are built tough without sacrificing comfort. IronWear overalls are designed in New Zealand for New Zealand body shapes, so you can be sure of a comfortable fit. Ideal for most rugged work environments, they're suitable for mechanics, farmers, engineers, rubbish removers, tradesmen and labourers.

- Double-washed, pre-shrunk fabric
- 280gsm 100% cotton
- Double-layer knees and seat.
- Large, rugged, double-ended front zip, easy to use while wearing gloves
- Breast pockets
- Hip pockets
- Seat pocket
- Pen pocket
- Ruler pocket
- Hip access to inner garments
- Size range: 4 - 15
- Screen printing and monogramming of name, company logo, etc also available

Product Codes

OAIWCOTNAV_ 100% Cotton Overall - Blue with No Tape 280gsm

IronWear Hi Vis wet weather 5 in 1 TTMC-W compliant



Features

QSI's IronWear 5 in 1 Jacket, Vest, and Bib Trousers are designed in New Zealand for New Zealand body shapes, so you can be sure of a comfortable fit.

Ideal for most rugged work environments, they're suitable for mechanics, farmers, engineers, rubbish removers, tradesmen and labourers.

Bib Trouser features include:

- 100% polyester 300D oxford PU coated for the body
- 13,000mm waterproof rating
- 3,000mm breathability rating
- TTMC-W transit compliant reflective tape front and back

Size range: S, M, L, XL, 2XL, 3XL, 5XL, 7XL

Screen printing and monogramming of name, company logo, etc also available.



Product Codes

WW5IN1JACK_	IronWear wet weather jacket
WW5IN1VEST_	IronWear wet weather vest
WW5IN1SET_	IronWear wet weather jacket and vest 5 in 1
WWBIBTROU_	IronWear wet weather bib trouser
WWTROU_	IronWear wet weather trouser

ICETEC freezer wear



Features

ICETEC Freezer Wear provides the ultimate protection for some of the most challenging working environments. Designed to be tough and flexible, ICETEC Freezer Wear protects you from the cold while still allowing you to move easily and work efficiently.

- AS/NZS 4602.1:2011 and AS/NZS 1906.4:2010 compliant
- Suitable for day or night use with high visibility reflective tape
- Heavy Duty 450d Oxford fabric outer shell (100% polyester) with water resistant PU coating
- 100% polyester lining with 320gsm quilted padding
- Seam sealed and waterproof
- Available in sizes S to 4XL as well as 6XL and 8XL

Product Codes

FWJACK(SIZE)	Freezer Wear Jacket
FWBIBTROU(SIZE)	Freezer Wear Bib Trouser



Fleece lined collar and removable hood for greater comfort.

A wide variety of dedicated pockets for ID, mobile phone and other cargo.

Elasticated inner wrist cuffs help keep sleeves in place and improve insulation.

Elasticated, adjustable shoulder straps on bib trousers aid flexibility.

Full length leg zips and hook & loop flaps for easy donning.

Reflective vests

Standards

- Orange with tape: Day/night use. TTMC-W transit compliant
- Lime with tape: Day/night use
- Pink with tape: Night Use Only
- Orange and lime - no tape: Day use only

High Vis day vest



Features

- Lightweight and high visibility
- Available in Orange or Lime
- Sizes: S - 6XL, 8XL. (Add size to product code when ordering.)
- Available in Orange or Lime

Product Codes

VESDAYO_	Hi Vis Day Vest - Orange
VESDAYY_	Hi Vis Day Vest - Lime

High Vis day / night vest



Features

- Reflective tape front and back
- Convenient ID storage pocket
- The Orange vest is Transit Compliant
- Sizes: XS - 6XL, 8XL, 10XL. (Add size to product code when ordering.)
- Available in Orange or Lime

Meets AS/NZS 1906.4:2010 and AS/NZS 4602.1:2011.

Product Codes

VESHIVISO_	Day/Night Hi Vis Vest - Orange
VESHIVISY_	Day/Night Hi Vis Vest - Lime

Kids Hi Vis vest



Features

- Lightweight and high visibility
- Reflective tape front and back
- Sleeveless Sizes: S - chest size 35mm - age 2-4 year old approx.
- Sleeveless Sizes: M - chest size 40mm - age 5-7 year old approx.
- Sleeveless Sizes: L - chest size 45mm - age 8-10 year old approx.
- (Add size to product code when ordering.)

Product Codes

VESHIVISO-CHILD-_	Childrens Vest Hi-Vis (with refl. tape) - Orange
VESHIVISY-CHILD-_	Childrens Vest Hi-Vis (with refl. tape) - Yellow



STMS vest



Features

- Lightweight and high visibility
- Reflective tape front and back
- Available in both sleeveless and long sleeve
- Sleeveless Sizes: XS - 6XL, 8XL, 10XL.
- Long Sleeve Sizes: S - 6XL, 8XL
- (Add size to product code when ordering.)

Product Codes

VESYELSTMS-_	Yellow Sleeveless Hi Vis STMS Vest
VESLSHVSTMSY_	Yellow Long Sleeve Hi Vis STMS Vest

High Vis long sleeve reflective vest



Features

- Reflective tape front and back
- The Orange vest is Transit Compliant
- Sizes: S - 6XL, 8XL. (Add size to product code when ordering.)
- Available in Orange or Lime.

Product Codes

VESLSHIVIS	Day/Night Hi Vis Long Sleeve Vest - Orange
VESLSHIVISY	Day/Night Hi Vis Long Sleeve Vest - Lime

High Vis short sleeve pink reflective vest



Features

- Lightweight and high visibility
- Reflective tape front and back
- Sizes: S - 4XL, 6XL, 8XL (Add size to product code when ordering.)

Please note: Pink vests do not comply with the Day Use colour standard because the standard only covers the yellow-orange-red colour spectrum.

Product Codes

VESHIVISP	Night Hi Vis Vest - Pink
-----------	--------------------------

Visitor vest



Features

Pink vests are the perfect choice for site visitors as they stand out among your staff in orange and lime vests.

- Lightweight and high visibility.
- Reflective tape front and back.

Sizes: S - 4XL, 6XL, 8XL. (Add size to product code when ordering.)

Please note: Pink vests do not comply with the Day Use colour standard because the standard only covers the yellow-orange-red colour spectrum.

Product Codes

VESHIVISPV_	Visitor Vest - Pink
-------------	---------------------

Electric Arc high visibility safety garments

High Visibility safety garments are manufactured to comply with AS/NZS 4602.1:2011 standards.

It is essential that the appropriate garment be worn at all times. Class D/N garments are suitable for use during the day or night. Class D garments are suitable for use only during the day when high visibility is required. Class N garments are suitable for use only during the night when retroreflective is required.



How to choose the correct flame resistant clothing

With all the options of new products being continuously brought into the market, it is important for a user to determine the level of flame resistant (FR) garment protection required, the comfort and weight to the user and the cost of the FR protection.

As long as you understand the benefits and limitations to the product you are purchasing, you will be able to make an accurate decision. There is a good reason some of the more prominent brands are slightly more costly than some unknown imported product. This is due to the fact that the fabric manufacturers have invested the time and money into the continuous improvement and quality management of their product. Look to fabrics that are market proven to ensure you are getting the best protection. As we better understand the risks presented in the everyday work environment we are better able to predict risk and prepare for any situation that may eventuate.

The first question that needs to be asked is "Who is at risk and who needs flame resistant (FR) protective garments?" The answer is pretty simple - any person who does work in a hazardous environment that may involve coming into contact with hot metal, grinding or welding sparks, electric arc, flash fire, explosions from gas or dust or general fires like rural fires.

Industries that would fall into these categories are, electricians, electric utility linesmen, refinery, chemical and pharmaceutical workers, workers in the pulp and paper industry, food processing, paint, rural fire fighters and many more industries as well as anyone who comes into contact with energized equipment like road workers and arborists working near power lines.

How do I choose what to garment to use?

With the global market becoming more accessible, the ability to import a finished garment has become a lot easier. There has been an increase in FR garment options and this has resulted in a misrepresentation of the garment's performance ability, creating a lot of confusion in the market.

The best way to determine what is best for your business is to make an informed decision based on fact. In order to do this you will need to understand the various types of products available to you and the pros and cons of each one. There are a lot of fabrics and blends as there are so many different application requirements.

Not all FR fabrics will do the same jobs

Let's take a systematic approach starting with the entry level fabric, moving up to the higher performance fabrics. The entry level, easy to obtain fabric of choice over the last few years has been a 100 percent FR treated cotton fabric. This garment is not inherently flame resistant such as QSI Spectron garments. A manufacturer will use specific combinations of chemicals and will soak or spray the material so it will have the ability to self-extinguish after being exposed to flames. The FR chemicals are "activated" by intense heat, producing char and gases that inhibit combustion. This is a treatment placed onto a finished fabric so the fire retardant materials lose their fire retardant properties after a number of washes. This is commonly known as a "50 wash garment". The drawback to this fabric is that normally, to achieve a suitable arc rating or long burn exposure, they need to be a heavier weight (260-270gsm = 8 Cal+), this makes them a little heavier and a little more uncomfortable in the hotter seasons. This is generally a 1 year use garment.

Locking in FR treatment

In the last few years some more advanced ways of locking the FR treatment into the core of the cotton fiber have come about. This has brought about some great technical fabrics that have 88 percent cotton with 12% nylon such as QSI Banwear. Unlike the basic treated cotton fabric the FR treatment gets released from the core of the fiber, taking longer to leach out.

In most occasions the life of the garment is depleted before the FR treatment is gone. This is still a fire-retardant fabric. The 12 percent nylon adds extra durability and makes this garment a more durable option. It would have around a two to three year lifespan. It also requires a heavier weight to get the better arc rating or longer burn performance (260-270gsm = 9 Cal+).

Genuine FR material

With the advancement of technologies, a lot of technical fibers have been developed to be genuine, inherently flame-resistant material. Some types of fibers are modacrylics, FR viscose, Kermel, Nomex and Kevlar. The fibers these materials are made from are inherently non-flammable. Inherently flame-resistant materials are not affected by proper laundering.

The challenge is that some of these fibers shrink when they come into contact with heat, others may be uncomfortable to wear and are not a soft fabric -- some are difficult to dye and fade easily.

Affordable options

A more affordable option that is now coming out into the market is a blend of a 50-60 percent synthetic fiber with a cotton blend like Protal. The synthetic fiber acts as an oxygen scavenger so it prevents the cotton from burning. This fabric is more durable than the cotton fabric alone and does not require a treatment for the FR properties.

The only drawback is that it may not be suitable for a longer flame exposure and is more suited to an arc flash environment where you have a very short exposure to a flame.

High end fabrics

The higher end fabrics that combine durability, long burn protection and light weight performance are normally a combination of two or more technical flame resistant fabrics like QSI Kermel with FR Viscose. They are generally lighter (245gsm = 8 Cal+).

They are also known as a three-to-four year garment due to the fact they do not lose their FR properties and the Kermel fibers are also more durable.

The advantages include:

- Light weight fire resistance performance
- High durability
- Colour durability
- Proven performance in severe environments
- No performance degradation through over-washing or incorrect washing

PPE must also be worn properly

- Avoid the use of polyester, nylon, polypropylene and polyamide undergarments (sports material). Use FR, cotton, wool or rayon underwear and T-Shirts - non-melting.
- Ensure appropriate size and fit (maintain air gap between body and garment)
- Close PPE correctly (buttons, zipper, Velcro, etc) always done up
- Do not roll up sleeves.
- Keep it clean - the garment should not have flammable contaminants on it. Follow the cleaning and maintenance instructions on the inside label. Only repair or modify the garment following the guidelines provided by the garment manufacturer.
- Outermost wear must be flame resistant - e.g. do not wear a PVC raincoat over a FR coverall in a FR environment.
- Recommended stock: It is recommended that 3 sets of selected suitable FR garments are purchased per employee. This allows for 1 to be worn, while 1 is laundered and then a spare to be kept in stock.
- Consider FR head, face, hands and foot protection too.

When do I replace my garments?

Fire retardant clothing can lose its FR properties before physical damage is noticeable. Any garment, flame resistant or fire retardant, that has any visible holes or tears, should be repaired or removed from service immediately. Get the manufacturer's guidelines on the longevity of the specific FR treatment you are using.

Choose the fabric that works for you



Kermel® clothing gives you total confidence and is the ultimate choice for protection from arc flash.

The risk of arc flash is a fact of life when working in high-voltage situations. We all hope it will never happen, but when it does you want to be wearing the best protection available.

Industry-leading Kermel® aramid fibre fabric is inherently non-flammable, with a high resistance to abrasion and chemicals, and FR protection is guaranteed for the life of the garment*. It is also more lightweight than many other competitive fabrics, with moisture-wicking properties that make it very comfortable to wear. Kermel® is your premium choice for long-lasting, hard-wearing protective clothing.

Specifications:

- Meets the requirements of AS/NZS 4602.1:2011
- ATPV ≤ 9.5Cal/cm²
- Garment Fabric: 50% Kermel® Aramid, 50% FR Viscose.
- Sewing Thread: Aramid flame retardant thread.
- Reflective Trim: Flame retardant AS/NZS 1906.4:1997 certified.
- Size Range: Shirt, Jacket, Trousers: S - 3XL
Overalls: 4 - 15

Product Codes

OAKERTOP_	Kermel® Shirt - Blue with half reflective tape.
OAKER_	Kermel® Overall (TTMC-W) - Orange and blue with full reflective tape.
OAKERJACK_	Kermel® Jacket (TTMC-W) - Orange and blue with full reflective tape.
OAKERTROU_	Kermel® Drawstring Trousers - Blue with half reflective tape.
OAKERTROUBL_	Kermel® Beltloop Trousers - Blue with half reflective tape.
	Kermel® Beltloop Trousers - Blue with half reflective tape.

Kermel® shirt

- Double-layer shoulder area for extra protection.
- Large chest pockets with hook & loop fastening flaps.
- FR reflective tape, dome cuffs and front.



Kermel® jacket

- Large chest pockets with hook & loop fastening flaps.
- Full FR reflective tape, TTMC-W.
- Robust front zip and adjustable hook & loop cuffs.



Kermel® overall

- Full reflective FR tape, TTMC-W.
- Double-layer knee pads.
- Large capacity cargo pockets.
- Hip tool pocket.



Kermel® drawstring trouser

- Twin front and cargo pockets.
- Dual-layer knee pads.
- Ankle zips.



Kermel® beltloop trouser

- Twin front and rear pockets.
- Single cargo pocket.
- Hip radio pocket.



Protal® remains comfortable and cool with new breathable technology previously impossible in FR protective clothing.

When a flame comes into contact with Protal®'s unique intimate blends, tiny amounts of inert, non-burning gasses push the oxygen away from the surface to stop the burning process. As soon as the flaming stops and the source is removed, gas production stops and a charred barrier remains – no melting, no dripping and no material sticking to the skin.

The charring action and protected integrity of the fabric gives the wearer valuable time to react appropriately, while being fully protected.

Specifications:

- Meets the requirements of AS/NZS 4602.1:2011
- ATPV ≤ 9.6Cal/cm2
- Garment Fabric: 55% Protal® Aramid, 45% Cotton.
- Sewing Thread: Aramid flame retardant thread.
- Reflective Trim: Flame retardant AS/NZS 1906.4:1997 certified.
- Size Range: 4 - 15

Product Codes

OAPRO_	Protal® (240gsm) Overall (TTMC-W) - Orange and blue with full reflective tape.
OAPROJACK_	Protal® (240gsm) Jacket - Orange and blue with full reflective tape.
OAPROTROU_	Protal® (240gsm) Drawstring Trousers - Blue with half reflective tape.

*Guarantee is dependent on regular laundering, strictly adhering to instructions.

Protal® shirt

- Double-layer shoulder area for extra protection.
- Large chest pockets with hook & loop fastening flaps.
- FR reflective tape, dome cuffs and front.



Protal® jacket

- Large chest pockets with hook & loop fastening flaps.
- Full FR reflective tape, TTMC-W.
- Robust front zip and adjustable hook & loop cuffs.



Protal® overall

- Full reflective FR tape, TTMC-W.
- Double-layer knee pads.
- Large capacity cargo pockets.
- Hip tool pocket.



Protal® drawstring trouser

- Twin front and cargo pockets.
- Dual-layer knee pads.
- Ankle zips.



Protal® beltloop trouser

- Twin front and rear pockets.
- Single cargo pocket.
- Hip radio pocket.



Banwear® gives you the best of both worlds: top-quality, long-lasting arc flash protection at an affordable price.

Banwear® harnesses the durability of nylon for long life and the heat resistant properties of cotton for improved protection. The blend of 88% cotton and 12% nylon eliminates the need to wear T-shirts to achieve industry standard protection.

Banwear® is the original extended wear life fabric. It offers a new level of comfort, safety and durability, delivering the best protection and lowest cost-per-wearing in the industry. Better still, FR protection is guaranteed for the life of the garment*.

Specifications:

- Meets the requirements of AS/NZS 4602.1:2011, ASTM 1506 and NFPA 2112.
- ATPV ≤ 9.6Cal/cm2
- Garment Fabric: 88% Cotton, 12% Nylon.
- Sewing Thread: Aramid flame retardant thread.
- Reflective Trim: Flame retardant AS/NZS 1906.4:1997 certified.
- Size Range: Shirt, Jacket, Trousers: S - 3XL; Overalls: 4 - 15

Product Codes

OABANSHIRT_	Banwear® Shirt - Blue with half reflective tape.
OABAN_	Banwear® Overall (TTMC-W) - Orange and blue with full reflective tape.
OABANJACK_	Banwear® Jacket (TTMC-W) - Orange and blue with full reflective tape.
OABANTROU_	Banwear® Drawstring Trousers - Blue with half reflective tape.
OABANTROUBL_	Banwear® Beltloop Trousers - Blue with half reflective tape.

*Guarantee is dependent on regular laundering, strictly adhering to instructions.

Banwear® overall

- Full reflective FR tape, TTMC-W.
- Large capacity cargo pockets and hip tool pocket.
- Double-layer knee pads.



Banwear® jacket

- Large chest pockets with hook & loop fastening flaps.
- Full reflective FR tape, TTMC-W.
- Robust front zip and adjustable hook & loop cuffs.



Banwear® shirt

- Double-layer shoulder area for extra protection.
- Large chest pockets with hook & loop fastening flaps.
- Half reflective FR tape.
- Dome cuffs and front.



Banwear® drawstring trouser

- Twin front and cargo pockets.
- Dual-layer knee pads.
- Ankle zips.



Banwear® beltloop trouser

- Twin front and rear pockets.
- Single cargo pocket.
- Hip radio pocket.



Need full arc flash protection at an unbelievably low price? Look no further than Spectron™ 100% FR Cotton.

Spectron™ is the perfect solution for affordable arc flash protection. It offers the familiar, breathable comfort of 100% cotton with a special treatment to provide full protection from arc flash, sparks and electrical fires.

The flash resistant properties of Spectron™ are guaranteed for up to 50 wash cycles*, making it a cost-effective choice for short-term contractors who may only need protection during a limited time frame.

Specifications:

- Meets the requirements of AS/NZS 4602.1:2011
- Tested to EN532 and ASTM D6413.
- ATPV ≤ 8.7Cal/cm2
- Garment Fabric: 100% FR Cotton.
- Sewing Thread: Aramid flame retardant thread.
- Reflective Trim: Flame retardant AS/NZS 1906.4:1997 certified.
- Size Range: Jacket, Trousers: 4 - 15
Bib Overall: S - 8XL
Overall: 4 - 16

Product Codes

OAFRTTMC_	Spectron™ Overall (TTMC-W) - Orange and blue with reflective tape.
OAFRBIB_	Spectron™ Bib Overall, Blue with reflective tape.
OAFRJACK_	Spectron™ Jacket (TTMC-W) - Orange and blue with reflective tape
OAFRTROU_	Spectron™ Drawstring Trousers, Blue with reflective tape.

*Guarantee is dependent on regular laundering, strictly adhering to instructions.

Spectron™ jacket

- Large chest pockets with hook & loop fastening flaps.
- Full reflective FR tape, TTMC-W.
- Robust front zip and adjustable hook & loop cuffs.



Spectron™ bib overall

- Adjustable elastic shoulder straps.
- Double-layer knee pads.
- Chest pockets, front pockets and hip tool pocket.



Spectron™ overall

- Full reflective FR tape, TTMC-W.
- Double-layer knee pads.
- Large capacity cargo pockets and hip tool pocket.
- Front and internal access pockets.



Spectron™ drawstring trouser

- Twin front and cargo pockets.
- Dual-layer knee pads.
- Ankle zips.



Comfort, protection, flexibility, durability, visibility. ArcDry™ ticks all the boxes.



ArcDry™ clothing gives you the perfect combination of FR protection and total comfort. Made from 100% cotton with TransDry™, ArcDry™ wicks away moisture in even the harshest conditions while active antimicrobial properties prevent the build-up of odorous micro-organisms.

Specifications:

- Meets the requirements of AS/NZS 4602.1:2011 and NFPA 70 E HRC 2.
- ATPV ≤ 10.6Cal/cm2
- Garment Fabric: 100% FR Cotton.
- Sewing Thread: Aramid flame retardant thread.
- Reflective Trim: Flame retardant, AS/NZS 1906.4:1997 certified.
- Size Range: S - 6XL

Why two full reflective options?

When the original TTMC-W standard was written, the polo shirt design had specific requirements around the length of the garment in the front and back. Unfortunately this didn't take arc-flash into consideration.

In order to meet the TTMC-W standard, we were forced to reduce the length of the front of the garment by 60mm. We believe this potentially leaves the wearer's lower stomach vulnerable to arc-flash.

On this basis, we recommend customers purchase our standard reflective tape polo shirt as it provides the same 4602.1 compliant reflective tape pattern as the TTMC-W model, but with extra length in the front of the garment for better arc-flash protection.

Product Codes

OAFRPOLO_	ArcDry™ Polo Shirt - Orange.
OAFRPOLOTR_	ArcDry™ Reflective Polo Shirt - Orange with reflective tape.
OAFRPOLOTRFL_	ArcDry™ Reflective Polo Shirt (TTMC-W) - Orange with reflective tape.



TTMC-W non-compliant design but improved arc-flash protection.



TTMC-W compliant design.

ArcStorm™ wet weather clothing brings together the best in water resistance and FR protection in the one garment.



ArcStorm™ clothing is the perfect choice for those needing flame retardant protection while working in extreme environments where rain or snow may be a factor.

The sturdy 300D Oxford flame resistant polyester outer shell resists tearing and abrasion damage and an antistatic PU coating provides protection from the elements while reducing the risk of arc flash. All garments in the range are seam sealed for added water protection.

ArcStorm™ garments are fully lined with FR cotton (or FR polyester fleece) providing excellent arc flash protection.

Product Codes

WWFRJACK_	ArcStorm™ Jacket (TTMC-W) - Orange and blue with reflective tape.
WWFRBIBTR_	ArcStorm™ Bib-Trouser - Orange and blue with reflective tape.
WWFRVEST_	ArcStorm™ Vest (TTMC-W) - Orange with reflective tape.

ArcStorm™ bib trouser

- Adjustable elastic shoulder straps.
- Full reflective FR tape.
- Front bib pocket with hook & loop flap.
- Ankle zips for easy donning.



Specifications:

- Meets the requirements of AS/NZS 4602.1:2011
- Tested to EN533-1, EN1149, AS/NZS 1906.4:1997 standards.
- Fluoro orange conforms to AS/NZS 1906.4 2010
- Reflective Trim: Flame retardant AS/NZS 1906.4:1997 certified.
- Size Range: S - 8XL
- Outer Shell: 300D Oxford Flame Resistant & Antistatic PU.
- Inner Linings: Flame Resistant cotton and flame resistant polyester polar fleece.
- Sewing Thread: Aramid flame retardant thread.

ArcStorm™ vest

- Twin hip and front pockets.
- Snug fitting high collar helps keep the rain out.
- Zips into the ArcStorm™ Jacket for extra protection.
- Full reflective FR tape, TTMC-W.
- Robust front zip and hook & loop flap.
- Warm polar fleece lining.



ArcStorm™ jacket

- Seamless shoulders.
- Removable polar fleece lining.
- Snug-fit hood with chin flap, folds away under collar when not in use.
- Dual-runner, non-locking zip.
- Twin waist pockets with hook & loop fastening flaps.
- Elasticated internal cuffs and adjustable outer cuffs.
- Full reflective FR tape, TTMC-W.

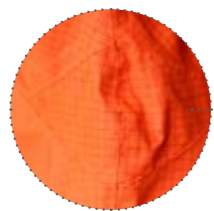

Flexible under-arm system prevents garment riding up when arms are raised.



Elasticated internal cuffs prevent water entering sleeve.



Snug fitting hood with chin flap and wide opening helps maintain peripheral vision.



Robust, dual runner, non-locking plastic zips with hook & loop protective flaps.



5-in-1 System - a jacket for all seasons.

The ArcStorm™ Jacket has a removable polar fleece lining allowing comfortable use in all seasons. The ArcStorm™ Vest also zips into the jacket in place of the original lining, providing an additional layer of warmth and protection.



Kermel® Protal® and Banwear®

Overall												
Size	4	5	6	7	8	9	10	11	12	13	14	15
Chest (cm)	108 - 112	112 - 116	116 - 120	120 - 125	125 - 130	130 - 135	133 - 138	138 - 143	143 - 148	148 - 153	153 - 159	159 - 165
Waist (cm)	96 - 99	99 - 102	102 - 106	106 - 110	110 - 115	115 - 120	120 - 125	125 - 130	130 - 135	135 - 140	140 - 146	146 - 151

Jacket												
Size	4	5	6	7	8	9	10	11	12	13	14	15
Chest (cm)	109 - 113	113 - 117	117 - 121	121 - 125	125 - 129	129 - 133	133 - 137	137 - 143	143 - 149	149 - 154	154 - 159	159 - 164

Drawstring Trouser												
Size	4	5	6	7	8	9	10	11	12	13	14	15
Waist (cm)	62 - 67	72 - 77	77 - 82	82 - 87	87 - 92	92 - 97	97 - 102	102 - 107	112 - 117	122 - 127	127 - 132	132 - 137

Long Sleeve Shirt							Belt Loop Trouser						
Size	S	M	L	XL	XXL	3XL	Size	S	M	L	XL	XXL	3XL
Chest (cm)	86 - 91	96 - 101	106 - 111	116 - 122	127 - 132	137 - 142	Waist (cm)	71 - 76	81 - 86	91 - 96	101 - 106	111 - 116	121 - 126
Chest (In)	34 - 36	38 - 40	42 - 44	46 - 48	50 - 52	54 - 56	Waist (In)	28 - 30	32 - 34	36 - 38	40 - 42	44 - 46	48 - 50



Spectron™

Overall													
Size	4	5	6	7	8	9	10	11	12	13	14	15	16
Chest (cm)	102 - 106	106 - 110	110 - 114	114 - 118	118 - 122	122 - 126	126 - 130	130 - 136	136 - 142	142 - 147	147 - 152	152 - 157	157 - 162
Waist (cm)	85 - 87	87 - 91	91 - 95	95 - 99	99 - 103	103 - 107	107 - 111	111 - 117	117 - 123	123 - 128	128 - 133	133 - 138	138 - 143

Bib Overall												
Size	S	M	L	XL	2XL	3XL	4XL	5XL	6XL	7XL	8XL	
Chest (cm)	97 - 100	100 - 103	103 - 106	106 - 109	109 - 112	112 - 116	116 - 120	120 - 126	126 - 132	132 - 137	137 - 142	
Waist (cm)	85 - 88	88 - 91	91 - 94	94 - 97	97 - 100	100 - 104	104 - 108	108 - 114	114 - 120	120 - 125	125 - 130	

Jacket												
Size	4	5	6	7	8	9	10	11	12	13	14	15
Chest (cm)	112 - 116	116 - 120	120 - 124	124 - 128	128 - 132	132 - 136	136 - 140	140 - 146	146 - 152	152 - 157	157 - 162	162 - 167

Drawstring Trouser												
Size	4	5	6	7	8	9	10	11	12	13	14	15
Waist (cm)	62 - 67	72 - 77	77 - 82	82 - 87	87 - 92	92 - 97	97 - 102	102 - 107	112 - 117	122 - 127	127 - 132	132 - 137



ArcDry™

Polo											
Size	XS	S	M	L	XL	2XL	3XL	4XL	5XL	6XL	7XL
Chest (cm)	100 - 104	105 - 108	109 - 112	113 - 116	117 - 121	122 - 126	127 - 131	132 - 136	137 - 140	141 - 144	145 - 148



ArcStorm™

Jacket											
Size	S	M	L	XL	2XL	3XL	4XL	5XL	6XL	7XL	8XL
Chest (cm)	125 - 130	130 - 135	135 - 140	140 - 145	145 - 150	150 - 155	155 - 160	160 - 165	165 - 170	170 - 175	175 - 180

Vest											
Size	S	M	L	XL	2XL	3XL	4XL	5XL	6XL	7XL	8XL
Chest (cm)	115 - 120	120 - 125	125 - 130	130 - 135	135 - 140	140 - 145	145 - 150	150 - 155	155 - 160	160 - 165	165 - 170

Bib Trouser											
Size	S	M	L	XL	2XL	3XL	4XL	5XL	6XL	7XL	8XL
Waist (cm)	92 - 97	97 - 102	102 - 107	107 - 112	112 - 117	117 - 122	122 - 127	127 - 132	132 - 137	137 - 142	142 - 147

On the front line of high-voltage electrical work, Banwear® Switching Garments help you get the job done safely.

Banwear® Switching Garments use multiple layers of 7oz arc flash resistant Banwear fabric to boost protection while maintaining comfort. Garments are available in both 2-layer and 3-layer options to suit a variety of situations.

We alternate the fabric colour in each layer so you can tell at a glance how many layers a garment has, and if the outer layer is damaged.

All jackets have hook & loop front closures, with the option of added zips on our long jackets.

We're not just thinking about electrical safety: our switching jackets use a Hi Vis orange for the outer fabric to ensure you can be seen on the job, with the option of reflective tape to aid night visibility.

Other options are available including detachable hoods and Chinese collars, so you can get the garment that works best for you.

Jackets come in a drawstring bag as standard, but you can upgrade to a robust backpack if you desire.

(See overleaf for more garments.)

Fabric Specifications:

- Meets the requirements of AS/NZS 4602.1:2011 where indicated.
- Meets the requirements of ASTM 1506, OSHA Regulation 29 CFR 1910-269, NFPA 2112 and NFPA 70E.
- Garment Fabric: 88% Cotton, 12% Nylon.
- Sewing Thread: Aramid flame retardant thread.
- Reflective Trim: Flame retardant, AS/NZS 1906.4:1997 certified.
- Size Range: S - 3XL

Switching garments - 2 layer

Product Codes	
FRSJAC25CAL_	Short Switching Jacket - 2 layer - 25 cal/cm2 (HRC3)
FRSJACH25CAL_	Short Switching Jacket with hood - 2 layer - 25 cal/cm2 (HRC3)
FRSJACT25CAL_	Short Switching Jacket with hood and reflective tape - 2 layer - 25 cal/cm2 (HRC3)
FRSJAC25CAL-UNI_	Short Switching Jacket with hood, mouth flap and reflective tape - 2 layer - 25 cal/cm2 (HRC3)
FRJAC25CAL_	Long Switching Jacket - 2 layer - 25 cal/cm2 (HRC3)
FRJAC25CALNP_	Long Switching Jacket with zip - 2 layer - 25 cal/cm2 (HRC3)
FRJAC25CALZIP_	Long Switching Jacket with hood, reflective tape and zip - 2 layer - 25 cal/cm2 (HRC3)
FRJAC25CALM-FZIP_	Long Switching Jacket with hood, mouth flap, reflective tape and zip - 2 layer - 25 cal/cm2 (HRC3)
FRBIB25CAL_	Bib Arc Trouser - 2 layer - 25 cal/cm2 (HRC3)

Switching garments - 3 layers

Product Codes	
FRSJAC49CAL_	Short Switching Jacket - 3 layer - 49 cal/cm2 (HRC4)
FRSJACH49CAL_	Short Switching Jacket with hood - 3 layer - 49 cal/cm2 (HRC4)
FRSJACT49CAL_	Short Switching Jacket with hood and reflective tape - 3 layer - 49 cal/cm2 (HRC4)
FRSJAC49CAL-UNI_	Short Switching Jacket with hood, mouth flap and reflective tape - 3 layer - 49 cal/cm2 (HRC4)
FRJAC49CAL_	Long Switching Jacket - 3 layer - 49 cal/cm2 (HRC4)
FRJAC49CALNP_	Long Switching Jacket with zip - 3 layer - 49 cal/cm2 (HRC4)
FRJAC49CALZIP_	Long Switching Jacket with hood, reflective tape and zip - 3 layer - 49 cal/cm2 (HRC4)
FRJAC49CALM-FZIP_	Long Switching Jacket with hood, mouth flap, reflective tape and zip - 3 layer - 49 cal/cm2 (HRC4)
FRBIB49CAL_	Bib Arc Trouser - 3 layer - 49 cal/cm2 (HRC4)

Short switching jacket - 25 cal or 49 cal

- With hood and protective mouth flap.
- Full reflective FR tape, TTMC-W.
- Elasticated cuffs.

Note: helmet and visor not included.



FRJAC25CALUNI_ - 25 CAL VERSION
FRJAC49CALUNI_ - 49 CAL VERSION

Long switching jacket - 25 cal or 49 cal

- With detachable hood.
- Full reflective FR tape, TTMC-W.
- Adjustable cuffs.

Note: helmet and visor not included.



FRJAC25CALZIP_ - 25 CAL VERSION
FRJAC49CALZIP_ - 49 CAL VERSION

Long switching jacket - 25 cal or 49 cal

- Adjustable cuffs.
- Optional front zips

Note: helmet and visor not included.



FRJAC25CAL_ - 25 CAL VERSION
FRJAC49CAL_ - 49 CAL VERSION

Bib arc trousers - 25 cal or 49 cal

- Adjustable waist.
- Ankle zips for easy donning.



FRBIB25CAL_ - 25 CAL VERSION
FRBIB49CAL_ - 49 CAL VERSION

Long switching jacket - 25 cal or 49 cal

- Adjustable cuffs.
- Optional detachable hood.
- Optional full reflective FR tape, TTMC-W

Note: helmet and visor not included.



FRSJAC25CAL_ - 25 CAL VERSION
FRSJAC49CAL_ - 49 CAL VERSION



FRJACH25CAL_ - 25 CAL VERSION
FRJACH49CAL_ - 49 CAL VERSION



FRJAC25CALUNI_ - 25 CAL VERSION
FRJAC49CALUNI_ - 49 CAL VERSION

FR helmet neck flap

- Available in single and double layer FR fabric.
- Attaches quickly and easily to the inside of helmet with hook & loop fastening.



NECKFLAPBAN - SINGLE LAYER BANWEAR
NECKCAPEKERMEL - SINGLE LAYER KERMEL
NECKCAPEKERMEL2 - DOUBLE LAYER KERMEL

FR helmet brim and neck flap

- Attaches securely to the brim of most safety helmets.
- Provides protection from the sun as well as FR protection.



NECKFLAPBAN

FR helmet chin strap

- Helps keep helmet in place in high winds and tight spaces.
- Attaches securely to the helmet harness.
- Heavy duty nylon buckle.
- Fully adjustable to suit a wide variety of users and helmets.



FRCHIN

FR balaclavas

- Various models available including dual-layer nomex and single-layer ArcStorm™ 100% cotton.
- Long neck design ensures better protective overlap between jacket and balaclava.
- Available in orange and white.



FRBALACLAVA8CALO



FRBALACLAVA

Product Codes

OABANHHBRIM	Banwear Brim with Back Flap for Hard Hat
NECKFLAPBAN	FR Helmet Brim and Neck Flap
NECKCAPEKERMEL	FR Helmet Neck Flap - Single Layer
NECKCAPEKERMEL2	FR Helmet Neck Flap - Double Layer
FRCHIN	FR Helmet Orange Chin Strap
FRBALACLAVA	Nomex 2-layer Balaclava
FRBALACLAVA8CALO	ArcDry™ 1-layer Balaclava - Orange



Industrial Coveralls

Industrial Coveralls

QSI brings you the ultimate in disposable safety clothing: Q-TECH industrial coveralls. Whether you're working with chemicals, asbestos, oil or paint, or simply in a dusty environment full of particulates, there's a Q-TECH coverall to suit your needs.

Q-TECH coveralls are fully certified to the relevant EN standards, giving you the peace-of-mind that the garments will perform, and are made from proven quality non-woven fabric that sets the benchmark for disposable safety clothing.

Thanks to QSI's scale and lean structure, we can deliver these high-end garments at some of the most competitive prices in the marketplace, giving you the protection you need at a price you can afford.



Sizing Chart

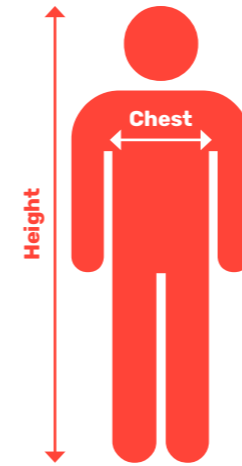

Size	Chest (CM)	Height (CM)
S	84-92	162-170
M	92-100	170-176
L	100-108	176-182
XL	108-116	182-188
XXL	116-124	188-194
XXXL	124-132	194-200

Sizes are according to EN340 standard.

IMPORTANT NOTE

- Garment sizes and specifications are subject to change without notice.
- QSI makes no guarantee of results and it is the user's responsibility to determine the level of hazard risk and the proper personal protective equipment needed.

Features



3-piece hood gives the optimal balance of a secure fit and ease of movement.



Tight sealing zip fastens right to the edge of the garment to better fit the contours of your face.



Wide storm flap protects the zip and helps prevent dust and liquid from penetrating.



Reinforced gusset offers the right combination of strength and flexibility for ease of movement.



Elasticated waist band helps garment to comfortably fit a wide range of body shapes.



Elasticated wrist and ankle openings form a snug fit to prevent contaminants from penetrating.

Medical Emergency Buyers Guide

The past few decades have seen a significant rise in the instance of drug-resistant illnesses, from the SARS threat of 2003, to the H5N1 (Avian Flu) virus of 2004-2007, to the most recent outbreak of Ebola haemorrhagic fever in West Africa.

The Q-TECH 2000 is the most suitable coverall in our range to help protect health workers and medical staff from the risks of such viral infections and other biological hazards.

The Q-TECH 2000 conforms to coverall standard Type 5 & Type 6. It provides protection from light spray and splashes of liquid chemicals, as well as hazardous dusts and dry particles. Moreover, the Q-TECH 2000 meets the EN14126 Standard (protection against biological hazards and infective agents) with particularly good performance in ISO16603:2004 (synthetic blood penetration resistance) and ISO22610:2006 (wet bacteria penetration resistance).

The quality of this product has been recognised around the world by various Ministries of Health and Centres for Disease Control (CDC) who have chosen the Q-Tech 2000 as a qualified 2-series protective disposable overall.

Q-TECH 2000 achieves the highest level of class 6 protection and is recommended for front-line medical personnel.

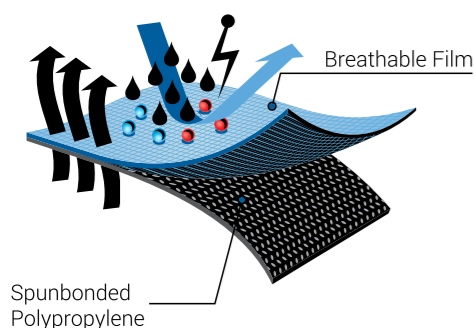

West Africa Ebola Outbreak

The Ebola outbreak has officially been declared a global health emergency by the World Health Organisation (WHO).

WHO strongly advises ebola health-care workers should receive appropriate training, equipment (gloves and personal protective equipment [PPE]) for treatment, plus instructions on proper removal and disposal of PPE.

As the route of infection is through contact with bodily fluids and not droplet spread, health workers require protective coveralls for Ebola, much more than for SARS.

So how do you choose the appropriate protective coveralls? Here are 3 aspects to consider:

Fabric - Does the fabric offer the protection you need?

Ebola virus typically measures 920nm in length and 80nm in diameter. The micropores of the Q-TECH 2000 are approximately 80~120nm in diameter and overlap each other, which allows air to pass through while keeping pathogens out.

CE Standard - Does the garment meet the required standards?

EN 14126 is a reference standard. Q-TECH 2000 meets EN14126 (protection against biological hazards and infective agents) with the highest level of performance in 4 out of 5 tests (ISO16603:2004 and ISO22610:2006, ISO22611:2003, and ISO22612:2005) as the chart below shows.

Comfort - Will the garment be comfortable enough for your working environment?

The ideal disposable coverall offers enough protection to keep Ebola out but is porous enough to allow a certain amount of air flow. The unique fabric of the Q-TECH 2000 gives the protection you need plus the breathable comfort required when working long hours in hot climates.



Fabric Resistance to Penetration of Infective Agents	Test Method EN14126:2003	EN 1149-1	EN 14126	EN 1073-2	TYPE 5-B	TYPE 6-B
Synthetic Blood Penetration Resistance	ISO 16603	Class 6	✓			
Blood-Borne Pathogen Penetration Resistance	ISO 16604	Class 1				
Contaminated Liquid Aerosols Penetration Resistance	ISO 22611	Class 3	✓			
Contaminated Solid Aerosols Penetration Resistance	ISO 22612	Class 3	✓			
Wet Bacteria Penetration Resistance	ISO 22610	Class 6	✓			

Coverall Standards Explained

Industrial coveralls fall into one of three categories depending on the level of protection they provide against various hazards.

Category I Simple products. Products which are not suitable to protect against any form of hazard.

Category II Intermediate products. Products which fall into neither category I or III.

Category III Complex products. Products which are worn or held in order to protect against any hazard which may be life threatening.



TYPE 1 BS EN 943-1
Gas tight suits. Suits which are intrinsically sealed against the environment.



TYPE 2 BS EN 943-1
Non-gas tight suits. Suits which retain a positive internal pressure to prevent ingress of dusts, liquids or vapours.



TYPE 3 BS EN 14605
Liquid tight suits. Suits which can protect against strong and directional jets of a liquid chemical such as spray from a burst pipe under pressure. Requires a barrier fabric and sealed seams.



TYPE 4 BS 1N 14605
Spray tight suits. Suits which can protect against saturation of liquid chemical, where volume of the liquid builds up on the suit forming pools, resulting in rivulets. Requires a barrier fabric and sealed seams.



TYPE 5 BS EN ISO 13982-1
Dry particle suits. Suits for protection against hazardous dusts and dry particles.



TYPE 6 BS EN 13034
Reduced spray suits. Suits for protection against light spray and splashes of liquid chemicals where there is no direction spray or build up of liquid on the suit, but there may be a fine mist of droplets in the atmosphere.



Anti-static EN 1149-5
Electrostatic dissipative protective clothing with a surface resistance of maximum 2.5 x 10 exp 9 ohm.



Radioactive contamination EN 1073-2
Protective clothing against particulate radioactive contamination.



EN 14126
Protection against biological hazards and infective agents.



Limited flame spread protection EN ISO 14116
Limited flame spread materials, material assemblies and clothing.

QTech 500 coverall



Features

The Q-TECH 500 is our standard disposable coverall, designed for light protection against non-toxic liquids and dust.

- Strong, durable and comfortable
- Individually wrapped or packaged in bulk
- CE Category 1 overall

Applications:

- Civil Defence
- Construction
- Painting and Decorating
- Food Processing and Packaging
- Medical and Emergency

Product Code

QTECH500_ Q-TECH 500 Industrial Coverall

QTech 1000L coverall (types 5 and 6) & FR version



EN 1073-2



TYPE 5



TYPE 6

Features

The Q-TECH 1000L (lightweight) sets a new benchmark for Type-5 and Type-6 garments: 30% lighter*, more breathable, better protection.

- Double layer PPSB improves fabric strength, tear and puncture resistance.
- Melt blown fabric laminated between the PPSB layers provides excellent particle barrier capabilities. The fabric filters resist 99.8% of particles of size 0.5-1µm.
- Passes EN1073-2 for protection against radioactive particulate contamination.
- Passes EN1149-5 for antistatic property (by option).
- Fully elasticated hood, ankles and wrists, to maximize comfort and protection.

Applications:

- Asbestos Handling
- Automotive
- Civil Protection
- Construction
- Painting and Decorating
- Waste Management

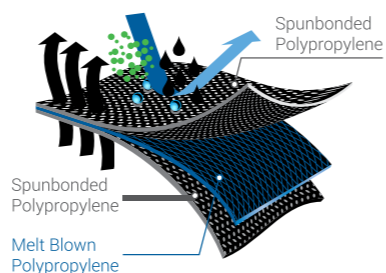

Stitched Seam

Reinforced 4-thread overlapped seam offers stronger seam strength and better protection.

Product Code

QTECH1000_ Q-TECH 1000L Industrial Coverall

QTECH1000FR Q-TECH 1000L FR Industrial Coverall

QTech 2000 coverall (types 5-B & 6-B)



EN 1149-1



EN 14126



EN 1073-2



TYPE 5-B



TYPE 6-B

Features

Q-TECH 2000 provides excellent protection from liquid chemical spray and biological hazards, while remaining breathable and comfortable.

The Q-TECH 2000 provides protection from light spray and splashes of liquid chemicals, as well as hazardous dusts and dry particles. It achieves the highest level of class 6 protection and is recommended for front-line medical personnel.

- Chemical liquid (EN368) and blood (ASTM F1670) penetration resistance for premium protection.
- Passes EN1149-5 for antistatic property.
- Passes EN1073-2 for protection against radioactive particulate contamination.
- Passes EN14126 for protection against biological hazards and infective agents (TYPE 5-B, 6-B)
- Low linting to reduce the risk of environment contamination.

Applications:

- Asbestos Handling
- Agriculture and Farming
- Automotive
- Biological Hazards
- Chemical Handling
- Clean Room
- Electronics
- Engineering
- Hazardous Materials
- Military
- Spray Painting
- Printing

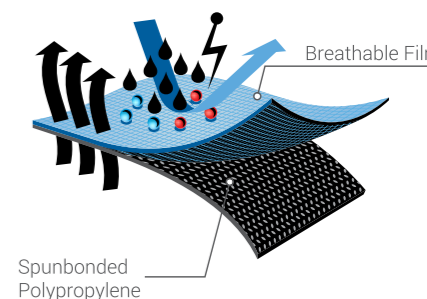

Product Code

QTECH2000_ Q-TECH 2000 Industrial Coverall

QTech 3000T coverall (types 4-B & 5-B & 6-B)



EN 1149-1



EN 14126



EN 1073-2



TYPE 5-B



TYPE 6-B

Features

the Q-TECH 3000T uses the same breathable barrier protection fabric as the 2000 but the taped seams provide an extra level of protection from saturation of liquid chemicals, especially important in situations where liquids may pool on the garment.

- Chemical liquid (EN368) and blood (ASTM F1670) penetration resistance for premium protection.
- Passes EN1149-5 for antistatic property.
- Passes EN1073-2 for protection against radioactive particulate contamination.
- Passes EN14126 for protection against biological hazards and infective agents (TYPE 4B, 5-B, 6-B)
- Low linting to reduce the risk of environment contamination.

Applications:

- Asbestos Handling
- Automotive
- Biological Hazards
- Chemical Handling
- Clean Room
- Decontamination
- Disaster Management
- Hazardous Material
- Industrial Cleanup
- Medical/Emergency
- Military
- Oil Handling/Tank Cleaning
- Spray Painting
- Printing
- Powder Coating
- Pharmaceutical

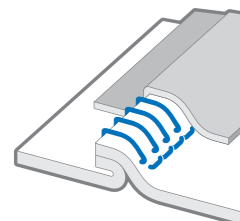

Stitched with Tape Seam
Stitched with chemical barrier tape seam for a higher barrier to particulate and liquid splashes.

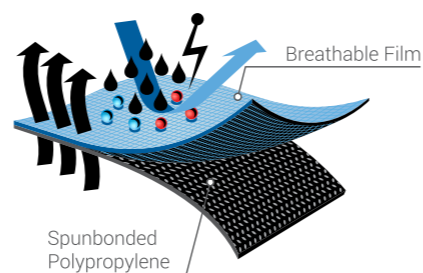

Product Code

QTECH3000_ Q-TECH 3000T Industrial Coverall



Q-TECH 1000L PRODUCT COMPARISON CHART

Use this chart to compare the Q-TECH 1000L industrial coverall with market equivalent products from other manufacturers to help you choose the garment that's right for you. This symbol indicates where the Q-TECH 1000L achieves the highest level of performance among its direct competitors.



Data Sources

- Testing results for the Q-TECH 1000L come from the independent testing laboratory, SGS, in the UK. Test data of other brands has been sourced from the following websites:
- **3M 4515:** http://multimedia.3m.com/mws/media/mediawebserver?mwsid=SSSSSuFSeVtSzxtU5x_Z58_xevUqevTSeVtSeVSeSSSSS--&fn=3ps1202_TDSSheets_4515_US_HR.pdf
 - **DuPont ProShield 10:** http://www2.dupont.com/Personal_Protection/en_GB/assets/PDF/IFU_ProShield_10.pdf
 - **Kimberly-Clark KleenGuard A20:** <http://www.kcprofessional.co.uk/media/3936947/cds-kleenguard-a20-breathable-particle-protection-coverall-9710-9715-v1-en.pdf>
 - **Microgard 1500 PLUS:** <http://www.microgard.com/product2.asp?MYID=2>
 - **Lakeland Safegard 76:** http://global.lakeland.com/uk/tech_data_safegard.pdf

QSI makes no guarantee as to the accuracy or reliability of this data and provides this information solely for reference purposes. QSI makes no claims as to the efficacy or otherwise of other companies' products.

Fabric Physical Properties	Test Method	Result	Class	3M	DuPont	Kimberly-Clark	Microgard	Lakeland	
Abrasion Resistance	EN530	>100	2	✓	2	2	2	>10<100	
Flex Cracking Resistance	ISO 7854 B	>40,000	5	✓	6	6	6	>100K	
Trapezoidal Tear Resistance	MD EN ISO9073-4	44.2N	3	✓	2	1	2	47.6N	
	CD	19.0N	1	✓	2	1	2	24.5N	
Tensile Strength	MD ISO 13934-1	113.5N	3	✓	1	1	1	77.9N	
	CD	44.5N	1	✓	1	1	1	49.2N	
Resistance to Ignition	EN13274-4	Pass	Pass	✓	Pass	Pass	Pass	Pass	
Puncture Resistance	EN863	9.7N	1	✓	1	1	1	6.1N	
Seam Strength	ISO13935-2	133.0N	4	✓	>50N	3	3	117.7N	
Against radioactive particulates	EN1073-2	Pass	1	✓	1	1	1	Pass	
Antistaticity	EN1149-5	Pass	Pass	✓	Pass	Pass	Pass	Pass	
pH value	EN ISO 3071	6.2	6.2	✓	6.2	6.2	6.2	6.2	
Fabric Physical Properties	Test Method	Penetration	Repeatability	Penetration	Repeatability	Penetration	Repeatability	Penetration	Repeatability
Resistance to Chemical Penetration	EN868	Class 3	Class 3	Class 3	Class 3	Class 3	Class 3	Class 3	Class 3
Sulphuric Acid 30%		Class 3	Class 3	Class 3	Class 3	Class 3	Class 3	Class 3	Class 3
Sodium Hydroxide 10%		Class 3	Class 3	Class 3	Class 3	Class 3	Class 3	Class 3	Class 3

Q-TECH 2000 PRODUCT COMPARISON CHART

Use this chart to compare the Q-TECH 2000 industrial coverall with market equivalent products from other manufacturers to help you choose the garment that's right for you. This symbol indicates where the Q-TECH 2000 achieves the highest level of performance among its direct competitors.



Data Sources

- Testing results for the Q-TECH 2000 come from the independent testing laboratory, SGS, in the UK. Test data of other brands has been sourced from the following websites:
- **3M 4545:** http://multimedia.3m.com/mws/media/mediawebserver?mwsid=SSSSSuFSeVtSzxtU5x_Z58TGeVtSeVtSeVSeSSSSS--&fn=3ps1202_TDSSheets_4545_US_LR0813
 - **DuPont Tyvek Classic:** http://phoenix.dpp-europe.com/IMG/pdf/IFU_Tyvek_Classic.pdf
 - **DuPont Tyvek Classic Xpert:** http://www2.dupont.com/Personal_Protection/en_GB/assets/PDF/IFU_Xpert.pdf
 - **Kimberly-Clark KleenGuard A40:** <http://www.kcprofessional.co.uk/media/4525312/product-information-kleenguard-apparel-selector-v1-en.pdf>
 - **Microgard 2000 Standard:** <http://www.microgard.com/product16.asp?MYID=16>
 - **Lakeland MicroMax NS:** http://global.lakeland.com/uk/tech_data_micromaxns.pdf
- QSI makes no guarantee as to the accuracy or reliability of this data and provides this information solely for reference purposes. QSI makes no claims as to the efficacy or otherwise of other companies' products.

Fabric Physical Properties	Test Method	Result	Class	3M	DuPont	Kimberly-Clark	Microgard	Lakeland	
Abrasion Resistance	EN530	>100 cycles	2	✓	2	2	2	>10<100	
Flex Cracking Resistance	ISO 7854 B	>40,000 cycles	5	✓	6	4	4	>15K<40K	
Trapezoidal Tear Resistance	MD EN ISO9073-4	40.7N	3	✓	1	1	2	40.7N	
	CD	18.6N	1	✓	1	1	2	16.7N	
Tensile Strength	MD ISO 13934-1	108.1N	3	✓	1	2	2	108.1N	
	CD	48.3N	1	✓	1	2	2	48.3N	
Inflammability	EN13274-4	Pass	2	✓	Pass	Pass	Pass	Pass	
Puncture Resistance	EN863	6.95N	1	✓	2	2	2	6.2N	
Seam Strength	ISO13935-2	120.2N	3	✓	3	3	3	111N	
Burst Resistance	ISO 13938-1	184.1kPa	3	✓	>75N	1	1	184.1kPa	
Antistaticity	EN1149-5	Pass	Pass	✓	Pass	Pass	Pass	Pass	
Radioactive particulates test	EN1073-2	Pass	1	✓	Pass	Pass	Pass	Pass	
Fabric Physical Properties	Test Method	Penetration	Repeatability	Penetration	Repeatability	Penetration	Repeatability	Penetration	Repeatability
Resistance to Chemical Penetration	EN868	Class 3	Class 3	Class 3	Class 3	Class 3	Class 3	Class 3	Class 3
Sulphuric Acid 30%		Class 3	Class 3	Class 3	Class 3	Class 3	Class 3	Class 3	Class 3
Sodium Hydroxide 10%		Class 3	Class 3	Class 3	Class 3	Class 3	Class 3	Class 3	Class 3
Iso propanol		Class 3	Class 3	Class 3	Class 3	Class 3	Class 3	Class 3	Class 3
Fabric Resistance to Penetration of Infective Agents	EN14126:2003	Class 6	Class 6	Class 3	Class 3	Class 3	Class 3	Class 3	Class 3
Synthetic Blood Penetration Resistance	ISO 16603	Class 6	Class 6	Class 3	Class 3	Class 3	Class 3	Class 3	Class 3
Blood-Borne Pathogen Penetration Resistance	ISO 16604	Class 1	Class 1	Class 0	Class 0	Class 0	Class 0	Class 0	Class 0
Contaminated Liquid Aerosols Penetration Resistance	ISO 22611	Class 3	Class 3	Class 3	Class 3	Class 3	Class 3	Class 3	Class 3
Contaminated Solid Particle Penetration Resistance	ISO 22612	Class 3	Class 3	Class 3	Class 3	Class 3	Class 3	Class 3	Class 3
Wet Bacteria Penetration Resistance	ISO 22610	Class 6	Class 6	Class 1	Class 1	Class 1	Class 1	Class 1	Class 1



General Safety Equipment

History of QSi and their knowledge of safety equip...

QSi has been designing and manufacturing safety products in New Zealand for over 18 years. Boasting onsite manufacturing facilities for industrial clothing, height safety, signage, respiratory and plastic injection moulding, we are innovating and providing more solutions to the market locally and internationally.

With our extensive range of health and safety brands, we cover most market needs from medical products, to custom branding and embroidery. Speak to one of our trusted resellers to get a solution you can trust.

QSi is proudly New Zealand owned and operated.



Safety Eyewear

Our range of safety glasses feature:

- Manufactured to AS/NZS 1337.1:2010 standard
- Anti-scratch hard coating
- Frameless wrap around style for superior comfort, a snug fit and less risk of particles or fluid getting in behind glasses
- Anti-fog lenses filter 99% of harmful UV rays

Clear lens safety glasses



Product Code

GLAM110ST	Clear lens safety glasses
-----------	---------------------------

Grey lens safety glasses



Product Code

GLAM120S	Grey lens safety glasses
----------	--------------------------

Amber lens safety glasses



Product Code

GLAM130S	Amber lens safety glasses
----------	---------------------------

Blue mirror safety glasses



Product Code

GLAWBLUEMIR	Blue mirror lens safety glasses
-------------	---------------------------------

Silver mirror lens safety glasses



Product Code

GLAM180S Silver mirror lens safety glasses

Child's safety glasses



Features

Children's clear lens glasses wrap around, scratch resistant, 99% UV resistance.

Product Code

GLAM110SC Silver mirror lens safety glasses

Green polycarbonate safety glasses



Features

Green lens glasses. Wrap-around, scratch resistant, 99% UV resistance.

Product Code

GLAGREEN Green polycarbonate safety glasses

Clear polycarbonate safety glasses



Features

Medium impact eye protector, anti-scratch and anti-fog, 99.9% UV protection. Meets AS/NZS 1337.

Product Code

GLAM210S Clear polycarbonate safety glasses

Grade 5 collapsible earmuff



Features

Collapsible lightweight Grade 5 earmuffs. Foam padded to ensure good seal. CE EN352-1 ANSI S3-19 compliant.

Product Codes

EARMUFCOLC5 Grade 5 collapsible earmuff

Baby earmuff



Features

Hearing protection for little ears. Built for children aged 3 months +. Suitable for: sporting events, drag races, concerts, car racing, air shows, boating, renovations, band practice, lawn mowing, vacuuming, drilling.

Product Codes

EARMUFFBABYG Earmuffs - Baby Banz - Green

EARMUFFBABYP Earmuffs - Baby Banz - Pink

Blue metal detectable corded ear plugs



Features

QTECH blue metal detectable corded ear plugs. Soft and easy to use. comes in individually packaged plastic bags.

- Disposable metal detectable PU foam
- Class 5 SLC80 26.2 dB
- Hearing protection for noise levels up to 110 dB(A)
- Contains 100 corded pairs
- Individually packaged
- Lightweight and comfortable

Product Codes

EARPLUGBLUBOX Blue Metal Detectable Disposable Ear Plugs With Cord

Nikki 3 Hard Hat



Features

- Anti-glare peak
- Quick-fit suspension
- Modern, stylish, and unique design
- 4 or 6 point chin strap attachment points
- UV inhibitor protects and extends life of helmet
- Contoured rain channel offers maximum rigidity
- Lightweight and comfortable fit, easy to wear all day
- One handed ratchet adjustable shock-absorbing suspension
- Lightweight ABS plastic offers excellent rigidity and protection (forestry poly version available)
- 4 or 6 point lightweight lining with soft absorbent crown and sweatband
- Slotted integration of wide range of accessories (earmuffs, faceshields, visors)
- Advanced permaweat breathable sweatband (easily replaceable and washable)
- Pad printing available for up to 4 colours
- Portion of your purchase goes towards Brain Injury Support



Manufactured to: **AS/NZS 1801:1997**
 NZ Des App. No. **424810**
 AU Des App. No. **201814688**



4 or 6 point lightweight lining with soft absorbent crown and sweatband



One handed ratchet adjustable shock-absorbing suspension



Vented

Non-Vented

NOTE - 4 point chin strap sold seperately



Nikki hard hat 3



Product Codes

HARHATNIK3_	Nikki Hard Hat - Vented
HARHATNIKNV3_	Nikki Hard Hat - Non-Vented

Available Colours: Red, DayGlo Orange, Yellow, DayGlo Lime, Pink, Light Blue, Dark Blue and White.
 (When ordering, add your preferred colour to the end of the product code.)

4-Point adjustable chin strap



Features

Adjustable 20mm black webbing chin strap with 4 velcro attachment points and a quick release buckle.

Product Codes

STRCHIN	Adjustable Chin Strap
---------	-----------------------

4-Point break away chin strap



Product Codes

CHINBW	4 Point Break Away Chin Strap for Hard Hats
--------	---

FFP2 moulded respirator



Features

This moulded mask features a metal noseclip and closed-cell foam nosepiece for superior seal, plus non-memory elastic to suit all head sizes.

Meets the following standards:

- EN149:2001
- AS/NZS 1716:2003
- CE 0086

20 units per box. 12 boxes per case.

Product Codes

HI8620 FFP2 moulded respirator - box 20

FFP2V moulded respirator with valve



Features

This mask is fitted with a valve to reduce breathing resistance. Also features a metal noseclip and close-cell foam nosepiece for superior seal, plus non-memory elastic to suit all head sizes.

Meets the following standards:

- EN149:2001
- AS/NZS 1716:2003
- CE 0086

10 units per box. 12 boxes per case.

Product Codes

HI8622 FFP2 moulded active carbon respirator with valve

FFP2CV moulded active carbon respirator with valve



Features

This mask features an active organic carbon layer to help remove odours from low-level organic vapour.

Also features a metal noseclip and close-cell foam nosepiece for superior seal, plus non-memory elastic to suit all head sizes.

Meets the following standards:

- EN149:2001
- AS/NZS 1716:2003
- CE 0086

10 units per box. 12 boxes per case.

Product Codes

HI8626 3 ply SPM with earloops

FFP2CV moulded active carbon respirator with valve diagram



Closed cell foam nosepiece is fully integrated into mask edge, providing superior seal in nasal area and helping prevent fogging of eyewear.

Lightweight alloy nose bridge works with foam nosepiece to increase seal of mask.

Reinforced flanges provide strong attachment points for strap without compromising the mask media.

Exhalation valve improves comfort by reducing heat and moisture build-up inside mask. (P2V and P2CV only).

Carbon layer absorbs harmful and irritating odours such as paint, oil, refuse and animal smells.

High quality elastic straps ensure even tension for the life of the mask, regardless of head size. Straps are welded into place, no need for staples.

Electrostatic media ensures efficient filtration of microscopic particles.

FFP2 duckbill respirator - ASTM level 3



Features

Duckbill style for universal fit.
 FFP2 Particulate respirator
 Industrial quality disposable respirator mask
 Meets the following standards:

- AS/NZS 1716:2003
- EN149:2001
- SANS 50149:2003

50 units per box. 20 boxes per case.

Product Codes

MASKN95P2F	Help-It Duckbill Mask P2/FFP2 High Efficiency ASTM Level 3
------------	---

3 ply tie on procedure mask - ASTM level 1



Features

- 99% Bacterial Filtration Efficiency
- High level filtration
- Low Breathing resistance
- Tie On fitting style
- Hypo allergenic
- Contains no latex or glass fibre

50 Units per box. 20 boxes per case.

Product Codes

MASKNZ3PLYTIES	Help-It 3ply Disposable Procedure Tie Masks ASTM Level 1
----------------	---

3 Ply Ear Loop Procedure Mask - ASTM Level 1



Features

- 99% Bacterial Filtration Efficiency
- High level filtration
- Low Breathing resistance
- Ear loop fitting style
- Hypo allergenic
- Contains no latex or glass fibre

50 Units per box. 20 boxes per case.

Product Codes

MASKIMP3PLYEL	Help-It 3 Ply Disposable Procedure Earloop Masks ASTM Level 1
---------------	--

General purpose ear loop mask medium - ASTM level 2



Features

- 99% Bacterial Filtration Efficiency
- High level filtration
- Low Breathing resistance
- Tie On fitting style
- Hypo allergenic
- Contains no latex or glass fibre

50 Units per box. 20 boxes per case.

Product Codes

MASKGPL2M	Help-It ASTM Level 2 GP Mask Size Medium
-----------	--

General purpose ear loop mask small - ASTM level 2



Features

- 99% Bacterial Filtration Efficiency
- High level filtration
- Low Breathing resistance
- Ear loop fitting style
- Hypo allergenic
- Contains no latex or glass fibre

50 Units per box. 20 boxes per case.

Product Codes

MASKGPL2S	Help-It ASTM Level 2 GP Mask Size Small
-----------	---

CleanSpace® RESPIRATORS



REVOLUTIONARY
RESPIRATORY
PROTECTION

IEC 60079-0:2011
IEC 60079-11:2011
Ex ia I Ma Ex ib IIB T4 Gb

Ex **CE** **2056** **red dot award 2016**
best of the best

WWW.QSISAFETY.COM

CLEANSPACE2™ CLEANSPACE ULTRA CLEANSPACE EX

CLEANSPACE2™

Powered P3 Respirator
Light, with no hoses, belts or
cables and no maintenance.
Particulate and Gas Filters

- High dust sites – quarries, mining
- Welding, grinding
- Maintenance and cleaning
- Timber and agriculture



CLEANSPACE™ ULTRA

Powered P3 respirator
With Rating IP 66
designed for use in
decontamination showers

- Chemical handling
- Lead abatement
- Infectious agents
- First responder



CLEANSPACE™ EX

Powered P3 respirator
Intrinsically safe certified
for use in potentially
explosive atmospheres

- Underground coal
- Oil and gas
- Petrochemical
- Chemical handling



Work Effortlessly and comfortably with HEPA Particulate Filtration (P3/TM3). Free Online Training.

CleanSpace is the only choice in protective masks to ensure compliance due to its comfort and one-button simplicity. Filtration efficiency 99.97% for particles 0.3 microns and above. Protects against dusts, mists, fumes and radionuclides. Ideal for lead, asbestos, silica and biohazards. Combination Gas filters also available.

1 POWER UNITS

CLEANSPACE2 PAPR
PAF-0034



CLEANSPACE ULTRA PAPR
PAF-0070



CLEANSPACE EX PAPR
PAF-0060



2 FACE MASKS

PAF-0033
Small

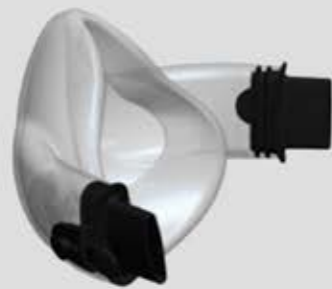

PAF-1010
Medium

PAF-0027
Large

PAF-1014
Full Face*



* Cleanspace
Ultra and
EX Only

3 FILTERS

PAF-0035
EN12942 TM3P HEPA
Particulate Filter
(Pack Of 3)



PAF-0037
Hi Capacity
(Hi Cap) Particulate
Filter P3 HEPA



PAF-0091
Combined: Organic,
Inorganic & Acid
Gas & Vapour
+ Particulate
AU:ABEP3

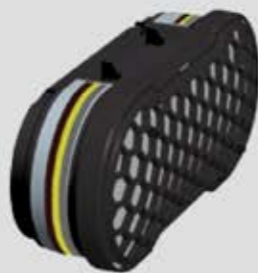

PAF-0072
Combined: Organic,
Inorganic, Acid
& Amonia Gas
+ Particulate
AU:ABEKP3



4 FILTER ADAPTOR

PAF-0038
Adaptor for
HiCap and
Gas filters



5 PRE-FILTERS & COVERS

PAF-0036
Pre-Filter
(Pack Of 10)



PAF-0058
CleanSpace™
Particulate Pre-Filter
& Coverall
(Standard Filter)



PAF-0057
CleanSpace™
Particulate Pre-Filter
(Large Case Filters)



PAF-0049
CleanSpace™
Coverall (Standard
& Large Case Filters)



OTHER ACCESSORIES

- PAF-0099** Backpack (Black)
- PAF-0075** Helmet Hook Strap
- PAF-0074** Ultra Cleaning & Storage Plug Set
- PAF-0025** Half Mask Adaptor for Quantitative Fit (PortaCount) Testing
- PAF-1015** Full Face Mask Quantitative Fit Test (PortaCount) Adaptor
- PAF-1018** Full Face Mask Tear off Visor Anti-Scratch Protectors (pack of 10)
- PAF-1017** Full Face Mask Spectacle Kit
- PAF-0049** Coverall (Standard and Large Case Filters) (pk 25)
- PAF-0048** (2 & Ultra) Charging Station for 10 motor units
- PAF-0079** EX Charging Station for 10 motor units

SPARES

- PAF-0014** CleanSpace2™ Neck Pad Thick (spare)
- PAF-0016** CleanSpace2™ Neck Pad Thin (spare)
- PAF-0028** Half Mask Exhalation Valve Assembly (pk 2) (spare)
- PAF-0030** CleanSpace2™ Head Harness (spare)
- PAF-0040** CleanSpace2™ & Ultra Battery Charger (spare)
- PAF-0066** EX Battery Charger (spare)
- PAF-0073** Ultra & EX Head Harness (spare)
- PAF-1012** Ultra & EX Neck Support Small (spare)
- PAF-1013** Ultra & EX Neck Support Large (spare)
- PAF-1016** Full Face Mask Harness Kit (spare)
- PAF-1019** Full Face Mask Exhalation Valve (pack of 2) (spare)
- PAF-1020** Full Face Mask Inhalation Valve (6 valves) (spare)
- PAF-1021** Full Face Mask Exhalation Valve Cover (spare)
- PAF-1022** Full Face Mask Orinasal Inner Mask Set (Small)
- PAF-1027** Full Face Mask Orinasal Inner Mask Set (Medium / Large) (spare)

HASP lock out



Product Codes

L001	HASP lock out - steel with vinyl coated - 1"
L002	HASP lock out - steel with vinyl coated - 1.5" - Red
L005	HASP aluminium lockout

Danger lock out tags



Product Codes

L006	'DANGER DO NOT OPERATE' lock out tag
L007	'DANGER DO NOT OPERATE Maintenance department' lock out tag
L008	'CAUTION DEFECTIVE' lock out tag

Lockout station



Product Codes

L009	20-locks - without cover
L010	20-locks - with cover

Stainless steel safety padlock



Product Codes

L003	Stainless steel with ABS body safety padlock - Blue
L011	Stainless steel with ABS body safety padlock - Green
L012	Stainless steel with ABS body safety padlock - Orange
L013	Stainless steel with ABS body safety padlock - Red
L014	Stainless steel with ABS body safety padlock - Yellow

Stainless steel cable safety padlock



Product Codes

L004	Stainless steel cable with ABS body safety padlock - Blue
L015	Stainless steel cable with ABS body safety padlock - Green
L016	Stainless steel cable with ABS body safety padlock - Orange
L017	Stainless steel cable with ABS body safety padlock - Red
L018	Stainless steel cable with ABS body safety padlock - Yellow

Road cone 5kg



Road Cone

- AS/NZS 1906.1.2007 Compliant
- 900mm tall
- Large studded base for extra stability
- Each cone weighs 5kg unballasted
- Dual reflective bands
- Manufactured from UV stable materials
- Contains no regrind material
- Corporate branding options available

Proudly manufactured in New Zealand.

Product Codes

ROADCONE	Orange Road Cone - 5kg
----------	------------------------

Narrow road cone 4.5kg



Road Cone

- AS/NZS 1906.1.2007 Compliant
- 900mm tall
- Large studded base for extra stability (35cm width)
- Each cone weighs 4.5kg unballasted
- Dual reflective bands
- Manufactured from UV stable materials
- Contains no regrind material
- Grip on top for easy handling
- Corporate branding options available

Proudly manufactured in New Zealand.

Product Codes

ROADCONENARROW	Orange Road Cone - Narrow 4.5kg
----------------	---------------------------------

Road cone bar



Features

- Yellow and black
- 1.3m - 2.2m retractable
- Fits on top of most road cones

Product Codes

CONEBAR1	Cone Bar - H/D PVC Barrier 1.3m - 2.2m retractable
CONEBARWH	Cone Bar - White H/D PVC Barrier w/red tpe 1.3m - 2.2m retractable

Road cone bar bag



Features

- Heavu duty PVC bag
- Holds 20 cone bars

Product Codes

CONEBAR1	Cone Bar - H/D PVC Barrier 1.3m - 2.2m retractable
----------	--

Transportation & Transit flags



FLAGOVER



FLAGSYELLOW



FLAGLIME



FLAGORANGETRI



FLAGYELLOW



FLAGRED

Features

- Heavy duty materials.
- Long lasting and durable.
- Many types available.

Product Codes

FLAGOVER	Hi Viz Lime PVC Flag 110cm x 30cm OVERSIZE with 4 x Eyelets
FLAGSYELLOW	Hi Viz Lime Flag 30cm x 40cm with 4 x Eyelets
FLAGLIME	Pair of Hi Viz Lime/Orange/Lime 45cm x 33cm with 4 x Eyelets
FLAGORANGETRI	Hi Viz Orange triangle flag - can be stapled onto wooden pole
FLAGYELLOW	Hi Viz Lime triangle which can be stapled onto wooden pole
FLAGRED	Red PVC Flag with Webbing and Clip

Warning Triangle



Features

Road Side Foldable Warning Triangle for Vehicles.

Product Codes

CDTRI	Warning Triangle
--------------	------------------

Fire extinguisher



Features

- ABE Powder Fire Extinguisher.
- Available in 1.0kg & 1.5kg
- Ideal for your vehicle or boat.
- Great addition to your camping equipment
- Wall mountable.

Product Codes

FIREXTV01	Fire Extinguisher
------------------	-------------------

Help-it 'Blaze Breaker' fire blankets



Features

Our burn blankets measure 1.2m x 1m and 1.8m x 1.2m. Very compact for easy storage. Wall hangable. (Pull release tabs to deploy.)

Certified to AS/NZS 3504:2006

Product Codes

BLABURN1.2MX1.2M	Fire Blanket 1.2x1.2m
BLABURN1.8MX1.2M	Burn Blanket 1.8m x 1.2m

Help-it industrial wipes



Features

Help-It™ antibacterial Monster Wipes are ideal for use in manufacturing, automotive, construction and other industrial workplaces. Large and strong, they are also great for the home workshop or garden shed.

They effectively remove dirt, grease, oils, silicones, cable filling compounds, paint, ink, caulking and adhesives from skin and most surfaces, while Vitamin E and aloe vera help moisturize and soften skin.

- Pack of 80 wipes.
- Size of wipes: 200 x 300mm

Product Codes

WIPEINDU	Help-It Industrial Wipes - Tub of 80
-----------------	--------------------------------------



Signage

Sign Printers

Whether it's digitally printed on vinyl or a traditionally screen printed PVC board, our signs are made right here in New Zealand.

Everyone knows the Kiwi environment is unique, with high levels of UV and varied, sometimes extreme weather. Many importers' products, mass produced in overseas factories, are just not able to withstand these conditions. We make our signs with materials chosen to suit these demands. Also, our standard sizes are a little larger than the international paper sizes of A4 and A3, so they're sure to be legible at the required distances.

Our signs come in a range of materials to offer a choice that suits the sign's location, environment and budget, the benefits of each of these materials is explained over the page. And because we make our own, if the 'off the shelf' options don't suit, we have the capabilities to supply custom signs in a variety of materials and sizes, including one-off signs with dry-erase whiteboard-style laminates, perfect for site checklists or emergency evacuation boards.



How to order your QSi signs

We've made it simple for you to find and order the signs that you need. Just go to the design range pages (use the contents table or the page-corner icons to quickly find the right range) and pick one of the size & material options shown for that sign!

Our standard sizes are chosen to suit the majority of safety sign situations. They are a little over A3 and A4 paper sizes, making them a bit bigger than many competitors' standard sizes. As a result, the designs differ slightly between sizes, as in the following examples:



Our design team ensure that these differences make the signs eye catching, clear and legible at all sizes, because a sign that can't be seen and read is no use at all.

Our signs, made to fit your requirements

We produce signs in a variety of materials, so that you can select the option that provides the best solution:

- 1 Screenprinted PVC board**
Weatherproof and durable, cost effective basic sign. 1.2mm PVC board (Drilled and radiused at four corners) out-performs many cheaper imported alternatives using thinner boards. Screenprinted with inks made for NZ environments. Ideal for 'high volume' signs, bespoke screenprinting available for quantities over 100 per design.
- 2 Screenprinted Sign Blank c/w Vinyl Text / Details on PVC board**
Combines the benefits of the above option with the flexibility of using 'low volume' or bespoke text content with standard sign layouts, ideal for one-offs and small quantities. Long lasting, purpose-made vinyl offers good performance.
- 3 Full Vinyl Decal on PVC (With Screw Holes)**
Using purpose-made materials to be weatherproof and durable, printed vinyl offers full colour/high detail capabilities. Supplied on 1.2mm PVC board drilled and radiused at four corners.
- 4 Full Vinyl Decal on PVC (No Screw Holes)**
As option 3 but with square corners and no drilled holes. Perfect for temporary/mobile signs or for using adhesives to fix them in position.
- 5 Full Vinyl Decal on PVC (No Screw Holes c/w double sided tape)**
As option 4 but supplied with double sided tape. Perfect for indoor applications such as identifying firefighting equipment or showing evacuation procedures, etc.
- 6 Full Vinyl Decal on Aluminium board**
Ideal for outdoor use or where conditions need a robust board. Produced using purpose-made materials to be weatherproof and durable. Drilled and radiused at the corners.
- 7 Full Vinyl Decal on Coreflute**
Light weight, low cost option. Ideal for situations not requiring ultimate performance or durability, such as temporary or indoor signage, where budget is the major consideration.
- 8 Self Adhesive Vinyl Sticker**
Printed on purpose-made materials to be weatherproof and durable and offering full colour/high detail capabilities. Custom sizes easily accommodated. Supplied on backing paper for your own application.
- 9 Full Vinyl Decal on Magnetic Backing**
For temporary magnetic fixing. Printed on purpose-made vinyl to be weatherproof and durable and offering full colour/high detail capabilities. Custom sizes easily accommodated.

What do the codes mean?

The codes show which size & material combinations the design is available in:

A1 — Material code
Size code

A1 — Codes shown in red indicate the stock combination for the design (other shown options may not be available from stock).

Size code

A 120mm x 120mm	1 Screenprinted on PVC board
B 180mm x 180mm	2 Screenprinted Blank c/w Vinyl Text & Details on PVC Board
C 240mm x 240mm	3 Full Vinyl Decal on PVC Board (With Drilled Screw holes)
D 250mm x 250mm	4 Full Vinyl Decal on PVC Board (No Drilled Screw Holes)
E 340mm x 120mm	5 Full Vinyl Decal on PVC Board (No Holes, with Double Sided Tape)
F 340mm x 240mm (or 240 x 340)	6 Full Vinyl Decal on Aluminium Board
G 450mm x 180mm	7 Full Vinyl Decal on Coreflute
H 450mm x 300mm (or 300 x 450)	8 Self Adhesive Vinyl Sticker
I 200mm x 400mm	9 Full Vinyl Decal on Magnetic Backing
J 600mm x 450mm	

Of course, not every combination is available for every design, so each illustration is accompanied by a series of codes to show you exactly what we produce as 'standard' for the sign. And if these don't match your requirements, we can usually produce what you need, just order it as a custom option instead! Have a look at the example for a better look at how it works, and remember that these codes are shown at the bottom of every 2-page spread, so you don't even need to remember them all!



Product Codes

QSI 3419

Size & Material Codes

E1, E3, E4, E5, E6, E7, E8
G3, G4, G5, G6, G7, G8

You don't need to remember all this, we've put the details at the bottom of all the pages for easy reference!

SIZE CODES

A 120mm x 120mm	D 250mm x 250mm	G 450mm x 180mm	J 600mm x 450mm
B 180mm x 180mm	E 340mm x 120mm	H 450mm x 300mm (or 300 x 450)	
C 240mm x 240mm	F 340mm x 240mm (or 240 x 340)	I 200mm x 400mm	

Fully equipped for responsive service

Modern technology means that signs can be produced more consistently, efficiently and with higher quality than ever before. QSi have invested in New Zealand manufacturing to provide a range of signs to meet the requirements and keep up with our evolving workplace legislation.



A dedicated production team provides a fast turnaround on non-standard signs and can provide proofs for custom designs that ensure you get the result you're after.



Modern workplace environments are constantly changing, and our signage department has the skills, resources and commitment to provide a unique combination of price and flexibility to New Zealand's commercial heartlands.

MATERIAL CODES

1 Screenprinted on PVC	4 Vinyl on PVC (No Screw Holes)	7 Vinyl on Coreflute
2 Screenprinted Blank c/w Vinyl Text on PVC	5 Vinyl on PVC (No Holes, c/w Dbl Sd Tape)	8 S/A Vinyl Sticker
3 Vinyl on PVC (With Screw holes)	6 Vinyl on Aluminium board	9 Vinyl on Magnetic

Pre-printed blanks to make specials easy

Every NZ workplace is unique, with different hazards and considerations, but they all need recognisable, standardised signage. So, for those occasions where the specifics of a site require a standard sign layout with non-standard content, our pre-screenprinted blanks make it quick and easy to get exactly the sign you need - it's almost like having every combination available off the shelf!

You will see that many of our sign ranges include this option, just look for the 'STOCK BLANKS' symbol.



Some ranges, such as the typical 'DANGER' sign shown above include designs that feature extra graphical elements (no smoking or no entry symbols, etc.) and these, or even unique symbols, can be incorporated into the signs built using the stock blanks, producing effective, clear signage for every client's requirement, such as:

- Do Not Feed The Animals
- No Vehicles
- BEWARE livestock roaming
- No Video Recording
- PLEASE No Littering

Off the shelf, customise or start from scratch

But what if the specific requirements don't work with the stock blanks? Well, no problem, we have a variety of 'template' designs for signs that need to be to a certain style, but vary dependent on the situation. From generic HAZCHEM boards that you can add the hazmat symbols as required to adaptable 'whiteboard' style templates perfect for site hazard lists, this new range is aimed at providing you with an easy and flexible solution to some of the more unusual sign requirements.

Our sales and design team will help you through the process, making sure you get the best signs for your needs in the shortest possible time.



Signage display stand

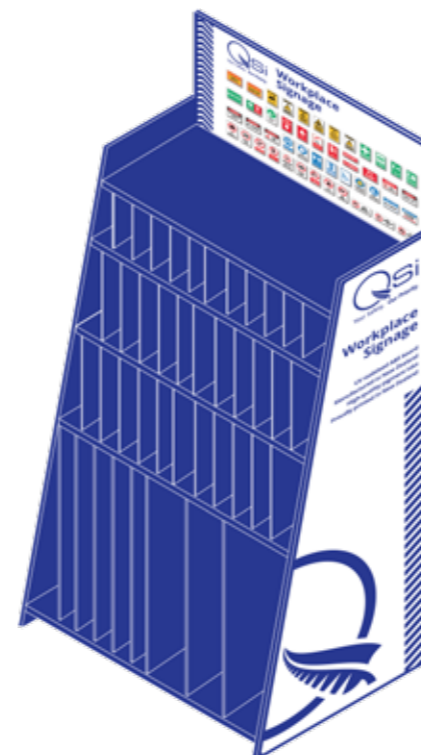

Features

- Display stand for our top selling signs
- Heavy duty wooden construction
- Quick reference chart to locate your desired sign
- Custom branding available
- Dimensions: 84cm wide x 62cm deep x 202cm tall

Product Codes

SIGNSTAND	Safety Signs Shelving Unit
-----------	----------------------------



Product Codes
QSI 3616

Size & Material Codes
F1 F3 F4 F5 F6 F7 F8
H1 H3 H4 H5 H6 H7 H8
J3 J4 J5 J6 J7 J8



Product Codes
QSI 3617

Size & Material Codes
F1 F3 F4 F5 F6 F7 F8
H1 H3 H4 H5 H6 H7 H8
J3 J4 J5 J6 J7 J8



Product Codes
QSI 3610

Size & Material Codes
F1 F3 F4 F5 F6 F7 F8
H1 H3 H4 H5 H6 H7 H8
J3 J4 J5 J6 J7 J8



Product Codes
QSI 3452

Size & Material Codes
E1 E3 E4 E5 E6 E7 E8
G1 G3 G4 G5 G6 G7 G8



Product Codes
QSI 3637

Size & Material Codes
F1 F3 F4 F5 F6 F7 F8
H1 H3 H4 H5 H6 H7 H8
J3 J4 J5 J6 J7 J8



Product Codes
QSI 3619

Size & Material Codes
F1 F3 F4 F5 F6 F7 F8
H1 H3 H4 H5 H6 H7 H8
J3 J4 J5 J6 J7 J8



Product Codes
QSI 3620

Size & Material Codes
F1 F3 F4 F5 F6 F7 F8
H1 H3 H4 H5 H6 H7 H8
J3 J4 J5 J6 J7 J8



Product Codes
QSI 3629

Size & Material Codes
F1 F3 F4 F5 F6 F7 F8
H2 H3 H4 H5 H6 H7 H8
J3 J4 J5 J6 J7 J8



Product Codes
QSI 3436

Size & Material Codes
E1 E3 E4 E5 E6 E7 E8
G1 G3 G4 G5 G6 G7 G8



Product Codes
QSI 3634

Size & Material Codes
F1 F3 F4 F5 F6 F7 F8
H2 H3 H4 H5 H6 H7 H8
J3 J4 J5 J6 J7 J8



Product Codes
QSI 3630

Size & Material Codes
F1 F3 F4 F5 F6 F7 F8
H2 H3 H4 H5 H6 H7 H8
J3 J4 J5 J6 J7 J8



Product Codes
QSI 3615

Size & Material Codes
F1 F3 F4 F5 F6 F7 F8
H2 H3 H4 H5 H6 H7 H8
J3 J4 J5 J6 J7 J8



Product Codes
QSI 3607

Size & Material Codes
F1 F3 F4 F5 F6 F7 F8
H2 H3 H4 H5 H6 H7 H8
J3 J4 J5 J6 J7 J8



Product Codes
QSI 3545

Size & Material Codes
E1 E3 E4 E5 E6 E7 E8
G1 G3 G4 G5 G6 G7 G8



Product Codes
QSI 3605

Size & Material Codes
F1 F3 F4 F5 F6 F7 F8
H2 H3 H4 H5 H6 H7 H8
J3 J4 J5 J6 J7 J8



Product Codes
QSI 3602

Size & Material Codes
F1 F3 F4 F5 F6 F7 F8
H2 H3 H4 H5 H6 H7 H8
J3 J4 J5 J6 J7 J8



Product Codes
QSI 3608

Size & Material Codes
F1 F3 F4 F5 F6 F7 F8
H2 H3 H4 H5 H6 H7 H8
J3 J4 J5 J6 J7 J8



Product Codes
QSI 3623

Size & Material Codes
F1 F3 F4 F5 F6 F7 F8
H2 H3 H4 H5 H6 H7 H8
J3 J4 J5 J6 J7 J8



Product Codes
QSI 3614

Size & Material Codes
F1 F3 F4 F5 F6 F7 F8
H2 H3 H4 H5 H6 H7 H8
J3 J4 J5 J6 J7 J8



Product Codes
QSI 3611

Size & Material Codes
F1 F3 F4 F5 F6 F7 F8
H2 H3 H4 H5 H6 H7 H8
J3 J4 J5 J6 J7 J8



Product Codes
QSI 3627

Size & Material Codes
F1 F3 F4 F5 F6 F7 F8
H2 H3 H4 H5 H6 H7 H8
J3 J4 J5 J6 J7 J8



Product Codes
QSI 3631

Size & Material Codes
F1 F3 F4 F5 F6 F7 F8
H2 H3 H4 H5 H6 H7 H8
J3 J4 J5 J6 J7 J8



Product Codes
QSI 3613

Size & Material Codes
F1 F3 F4 F5 F6 F7 F8
H2 H3 H4 H5 H6 H7 H8
J3 J4 J5 J6 J7 J8



Product Codes
QSI 3775

Size & Material Codes
F1 F3 F4 F5 F6 F7 F8
H2 H3 H4 H5 H6 H7 H8
J3 J4 J5 J6 J7 J8

SIZE CODES

- A 120mm x 120mm D 250mm x 250mm G 450mm x 180mm J 600mm x 450mm
- B 180mm x 180mm E 340mm x 120mm H 450mm x 300mm (or 300 x 450)
- C 240mm x 240mm F 340mm x 240mm (or 240 x 340) I 200mm x 400mm

MATERIAL CODES

- 1 Screenprinted on PVC 4 Vinyl on PVC (No Screw Holes) 7 Vinyl on Coreflute
- 2 Screenprinted Blank c/w Vinyl Text on PVC 5 Vinyl on PVC (No Holes, c/w Dbl Sd Tape) 8 S/A Vinyl Sticker
- 3 Vinyl on PVC (With Screw holes) 6 Vinyl on Aluminium board 9 Vinyl on Magnetic



Product Codes

QSI 3772

Size & Material Codes

F1 F3 F4 F5 F6 F7 F8
H3 H4 H5 H6 H7 H8
J3 J4 J5 J6 J7 J8



Product Codes

QSI 3774

Size & Material Codes

F1 F3 F4 F5 F6 F7 F8
H3 H4 H5 H6 H7 H8
J3 J4 J5 J6 J7 J8



Product Codes

QSI 3773

Size & Material Codes

F1 F3 F4 F5 F6 F7 F8
H3 H4 H5 H6 H7 H8
J3 J4 J5 J6 J7 J8



Product Codes

QSI 3635

Size & Material Codes

F1 F3 F4 F5 F6 F7 F8
H3 H4 H5 H6 H7 H8
J3 J4 J5 J6 J7 J8



Product Codes

QSI 3603

Size & Material Codes

F1 F3 F4 F5 F6 F7 F8
H3 H4 H5 H6 H7 H8
J3 J4 J5 J6 J7 J8



Product Codes

QSI 3544

Size & Material Codes

E1 E3 E4 E5 E6 E7 E8
G3 G4 G5 G6 G7 G8



Product Codes

QSI 3901

Size & Material Codes

F1 F3 F4 F5 F6 F7 F8
H3 H4 H5 H6 H7 H8
J3 J4 J5 J6 J7 J8



Product Codes

QSI 3902

Size & Material Codes

F1 F3 F4 F5 F6 F7 F8
H3 H4 H5 H6 H7 H8
J3 J4 J5 J6 J7 J8



Product Codes

QSI 3527

Size & Material Codes

F1 F3 F4 F5 F6 F7 F8
H3 H4 H5 H6 H7 H8
J3 J4 J5 J6 J7 J8



Product Codes

QSI 3609

Size & Material Codes

F1 F3 F4 F5 F6 F7 F8
H3 H4 H5 H6 H7 H8
J3 J4 J5 J6 J7 J8



Product Codes

QSI 3632

Size & Material Codes

F1 F3 F4 F5 F6 F7 F8
H3 H4 H5 H6 H7 H8
J3 J4 J5 J6 J7 J8



Product Codes

QSI 3621

Size & Material Codes

F1 F3 F4 F5 F6 F7 F8
H3 H4 H5 H6 H7 H8
J3 J4 J5 J6 J7 J8



Product Codes

QSI 3612

Size & Material Codes

F1 F3 F4 F5 F6 F7 F8
H3 H4 H5 H6 H7 H8
J3 J4 J5 J6 J7 J8



Product Codes

QSI 3546

Size & Material Codes

E1 E3 E4 E5 E6 E7 E8
G3 G4 G5 G6 G7 G8



Product Codes

QSI 3624

Size & Material Codes

F1 F3 F4 F5 F6 F7 F8
H3 H4 H5 H6 H7 H8
J3 J4 J5 J6 J7 J8



Product Codes

QSI 3633

Size & Material Codes

F1 F3 F4 F5 F6 F7 F8
H3 H4 H5 H6 H7 H8
J3 J4 J5 J6 J7 J8



Product Codes

QSI 3604

Size & Material Codes

F1 F3 F4 F5 F6 F7 F8
H3 H4 H5 H6 H7 H8
J3 J4 J5 J6 J7 J8



Product Codes

QSI 3622

Size & Material Codes

F1 F3 F4 F5 F6 F7 F8
H3 H4 H5 H6 H7 H8
J3 J4 J5 J6 J7 J8



Product Codes

QSI 3900

Size & Material Codes

F1 F3 F4 F5 F6 F7 F8
H3 H4 H5 H6 H7 H8
J3 J4 J5 J6 J7 J8



Product Codes

QSI 3636

Size & Material Codes

F1 F3 F4 F5 F6 F7 F8
H3 H4 H5 H6 H7 H8
J3 J4 J5 J6 J7 J8



Product Codes

QSI 3601

Size & Material Codes

F1 F3 F4 F5 F6 F7 F8
H3 H4 H5 H6 H7 H8
J3 J4 J5 J6 J7 J8



Product Codes

QSI 3618

Size & Material Codes

F1 F3 F4 F5 F6 F7 F8
H3 H4 H5 H6 H7 H8
J3 J4 J5 J6 J7 J8



Product Codes

QSI 3625

Size & Material Codes

F1 F3 F4 F5 F6 F7 F8
H3 H4 H5 H6 H7 H8
J3 J4 J5 J6 J7 J8



Product Codes

QSI 3599

Size & Material Codes

F1 F3 F4 F5 F6 F7 F8
H3 H4 H5 H6 H7 H8
J3 J4 J5 J6 J7 J8

SIZE CODES

- A 120mm x 120mm D 250mm x 250mm G 450mm x 180mm J 600mm x 450mm
- B 180mm x 180mm E 340mm x 120mm H 450mm x 300mm (or 300 x 450)
- C 240mm x 240mm F 340mm x 240mm (or 240 x 340) I 200mm x 400mm

MATERIAL CODES

- 1 Screenprinted on PVC 4 Vinyl on PVC (No Screw Holes) 7 Vinyl on Coreflute
- 2 Screenprinted Blank c/w Vinyl Text on PVC 5 Vinyl on PVC (No Holes, c/w Dbl Sd Tape) 8 S/A Vinyl Sticker
- 3 Vinyl on PVC (With Screw holes) 6 Vinyl on Aluminium board 9 Vinyl on Magnetic



Product Codes

QSI 3626

Size & Material Codes

F1 F3 F4 F5 F6 F7 F8
H2 H3 H4 H5 H6 H7 H8
J3 J4 J5 J6 J7 J8



Product Codes

QSI 3606

Size & Material Codes

F1 F3 F4 F5 F6 F7 F8
H2 H3 H4 H5 H6 H7 H8
J3 J4 J5 J6 J7 J8



Product Codes

QSI 3914

Size & Material Codes

F2
H2
J2



Product Codes

QSI 3639

Size & Material Codes

H1 H3 H4 H5 H6 H7 H8



Product Codes

QSI 3640

Size & Material Codes

H1 H3 H4 H5 H6 H7 H8
J3 J4 J5 J6 J7 J8



Product Codes

QSI 3670

Size & Material Codes

H1 H3 H4 H5 H6 H7 H8



Product Codes

QSI 3779

Size & Material Codes

H1 H3 H4 H5 H6 H7 H8



Product Codes

QSI 3780

Size & Material Codes

H1 H3 H4 H5 H6 H7 H8



Product Codes

QSI 3861

Size & Material Codes

H1 H3 H4 H5 H6 H7 H8
J3 J4 J5 J6 J7 J8



Product Codes

QSI 3434

Size & Material Codes

F1 F3 F4 F5 F6 F7 F8
H3 H4 H5 H6 H7 H8
J3 J4 J5 J6 J7 J8



Product Codes

QSI 3415

Size & Material Codes

F1 F3 F4 F5 F6 F7 F8
H3 H4 H5 H6 H7 H8
J3 J4 J5 J6 J7 J8



Product Codes

QSI 3437

Size & Material Codes

F1 F3 F4 F5 F6 F7 F8
H3 H4 H5 H6 H7 H8
J3 J4 J5 J6 J7 J8



Product Codes

QSI 3463

Size & Material Codes

F1 F3 F4 F5 F6 F7 F8
H3 H4 H5 H6 H7 H8
J3 J4 J5 J6 J7 J8



Product Codes

QSI 3472

Size & Material Codes

F1 F3 F4 F5 F6 F7 F8
H3 H4 H5 H6 H7 H8
J3 J4 J5 J6 J7 J8



Product Codes

QSI 3462

Size & Material Codes

G1 G3 G4 G5 G6 G7 G8



Product Codes

QSI 3485

Size & Material Codes

F1 F3 F4 F5 F6 F7 F8
H3 H4 H5 H6 H7 H8
J3 J4 J5 J6 J7 J8



Product Codes

QSI 3477

Size & Material Codes

F1 F3 F4 F5 F6 F7 F8
H3 H4 H5 H6 H7 H8
J3 J4 J5 J6 J7 J8

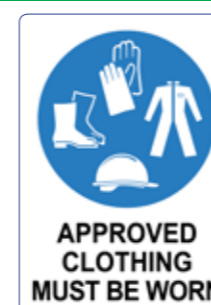

Product Codes

QSI 3746

Size & Material Codes

F1 F3 F4 F5 F6 F7 F8
H3 H4 H5 H6 H7 H8
J3 J4 J5 J6 J7 J8

SIZE CODES

- A 120mm x 120mm D 250mm x 250mm G 450mm x 180mm J 600mm x 450mm
- B 180mm x 180mm E 340mm x 120mm H 450mm x 300mm (or 300 x 450)
- C 240mm x 240mm F 340mm x 240mm (or 240 x 340) I 200mm x 400mm

MATERIAL CODES

- 1 Screenprinted on PVC
- 2 Screenprinted Blank c/w Vinyl Text on PVC
- 3 Vinyl on PVC (With Screw holes)
- 4 Vinyl on PVC (No Screw Holes)
- 5 Vinyl on PVC (No Holes, c/w Dbl Sd Tape)
- 6 Vinyl on Aluminium board
- 7 Vinyl on Coreflute
- 8 S/A Vinyl Sticker
- 9 Vinyl on Magnetic



Product Codes

QSI 3484

Size & Material Codes

F1 F3 F4 F5 F6 F7 F8
H3 H4 H5 H6 H7 H8
J3 J4 J5 J6 J7 J8



Product Codes

QSI 3464

Size & Material Codes

F1 F3 F4 F5 F6 F7 F8
H3 H4 H5 H6 H7 H8
J3 J4 J5 J6 J7 J8



Product Codes

QSI 3492

Size & Material Codes

G1 G3 G4 G5 G6 G7 G8



Product Codes

QSI 3478

Size & Material Codes

F1 F3 F4 F5 F6 F7 F8
H3 H4 H5 H6 H7 H8
J3 J4 J5 J6 J7 J8



Product Codes

QSI 3486

Size & Material Codes

G1 G3 G4 G5 G6 G7 G8



Product Codes

QSI 3468

Size & Material Codes

F1 F3 F4 F5 F6 F7 F8
H3 H4 H5 H6 H7 H8
J3 J4 J5 J6 J7 J8



Product Codes

QSI 3488

Size & Material Codes

G1 G3 G4 G5 G6 G7 G8



Product Codes

QSI 3749

Size & Material Codes

F1 F3 F4 F5 F6 F7 F8
H3 H4 H5 H6 H7 H8
J3 J4 J5 J6 J7 J8



Product Codes

QSI 3750

Size & Material Codes

F1 F3 F4 F5 F6 F7 F8
H3 H4 H5 H6 H7 H8
J3 J4 J5 J6 J7 J8



Product Codes

QSI 3487

Size & Material Codes

G1 G3 G4 G5 G6 G7 G8



Product Codes

QSI 3470

Size & Material Codes

F1 F3 F4 F5 F6 F7 F8
H3 H4 H5 H6 H7 H8
J3 J4 J5 J6 J7 J8



Product Codes

QSI 3491

Size & Material Codes

G1 G3 G4 G5 G6 G7 G8



Product Codes

QSI 3898

Size & Material Codes

F1 F3 F4 F5 F6 F7 F8
H3 H4 H5 H6 H7 H8
J3 J4 J5 J6 J7 J8



Product Codes

QSI 3483

Size & Material Codes

F1 F3 F4 F5 F6 F7 F8
H3 H4 H5 H6 H7 H8
J3 J4 J5 J6 J7 J8



Product Codes

QSI 3471

Size & Material Codes

F1 F3 F4 F5 F6 F7 F8
H3 H4 H5 H6 H7 H8
J3 J4 J5 J6 J7 J8



Product Codes

QSI 3489

Size & Material Codes

G1 G3 G4 G5 G6 G7 G8



Product Codes

QSI 3481

Size & Material Codes

F1 F3 F4 F5 F6 F7 F8
H3 H4 H5 H6 H7 H8
J3 J4 J5 J6 J7 J8



Product Codes

QSI 3787

Size & Material Codes

F1 F3 F4 F5 F6 F7 F8
H3 H4 H5 H6 H7 H8
J3 J4 J5 J6 J7 J8

SIZE CODES

- A 120mm x 120mm D 250mm x 250mm G 450mm x 180mm J 600mm x 450mm
- B 180mm x 180mm E 340mm x 120mm H 450mm x 300mm (or 300 x 450)
- C 240mm x 240mm F 340mm x 240mm (or 240 x 340) I 200mm x 400mm

MATERIAL CODES

- 1 Screenprinted on PVC 4 Vinyl on PVC (No Screw Holes) 7 Vinyl on Coreflute
- 2 Screenprinted Blank c/w Vinyl Text on PVC 5 Vinyl on PVC (No Holes, c/w Dbl Sd Tape) 8 S/A Vinyl Sticker
- 3 Vinyl on PVC (With Screw holes) 6 Vinyl on Aluminium board 9 Vinyl on Magnetic



Product Codes

QSI 3476

Size & Material Codes

F1 F3 F4 F5 F6 F7 F8
H3 H4 H5 H6 H7 H8
J3 J4 J5 J6 J7 J8



Product Codes

QSI 3490

Size & Material Codes

G1 G3 G4 G5 G6 G7 G8



Product Codes

QSI 3480

Size & Material Codes

F1 F3 F4 F5 F6 F7 F8
H3 H4 H5 H6 H7 H8
J3 J4 J5 J6 J7 J8



Product Codes

QSI 3842

Size & Material Codes

F1 F3 F4 F5 F6 F7 F8
H1 H3 H4 H5 H6 H7 H8
J3 J4 J5 J6 J7 J8



Product Codes

QSI 3513

Size & Material Codes

F1 F3 F4 F5 F6 F7 F8
H3 H4 H5 H6 H7 H8
J3 J4 J5 J6 J7 J8



Product Codes

QSI 3473

Size & Material Codes

F1 F3 F4 F5 F6 F7 F8
H3 H4 H5 H6 H7 H8
J3 J4 J5 J6 J7 J8



Product Codes

QSI 3479

Size & Material Codes

F1 F3 F4 F5 F6 F7 F8
H3 H4 H5 H6 H7 H8
J3 J4 J5 J6 J7 J8



Product Codes

QSI 3474

Size & Material Codes

F1 F3 F4 F5 F6 F7 F8
H3 H4 H5 H6 H7 H8
J3 J4 J5 J6 J7 J8



Product Codes

QSI 3475

Size & Material Codes

F1 F3 F4 F5 F6 F7 F8
H3 H4 H5 H6 H7 H8
J3 J4 J5 J6 J7 J8

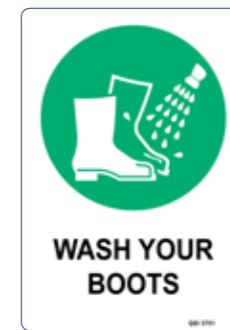

Product Codes

QSI 3751

Size & Material Codes

F1 F3 F4 F5 F6 F7 F8
H3 H4 H5 H6 H7 H8
J3 J4 J5 J6 J7 J8



Product Codes

QSI 3748

Size & Material Codes

F1 F3 F4 F5 F6 F7 F8
H3 H4 H5 H6 H7 H8
J3 J4 J5 J6 J7 J8

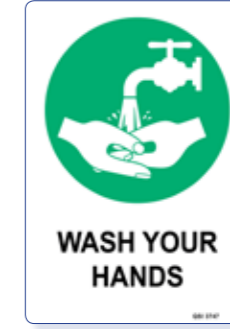

Product Codes

QSI 3747

Size & Material Codes

F1 F3 F4 F5 F6 F7 F8
H3 H4 H5 H6 H7 H8
J3 J4 J5 J6 J7 J8

SIZE CODES

- A 120mm x 120mm D 250mm x 250mm G 450mm x 180mm J 600mm x 450mm
- B 180mm x 180mm E 340mm x 120mm H 450mm x 300mm (or 300 x 450)
- C 240mm x 240mm F 340mm x 240mm (or 240 x 340) I 200mm x 400mm

MATERIAL CODES

- 1 Screenprinted on PVC 4 Vinyl on PVC (No Screw Holes) 7 Vinyl on Coreflute
- 2 Screenprinted Blank c/w Vinyl Text on PVC 5 Vinyl on PVC (No Holes, c/w Dbl Sd Tape) 8 S/A Vinyl Sticker
- 3 Vinyl on PVC (With Screw holes) 6 Vinyl on Aluminium board 9 Vinyl on Magnetic



Product Codes

QSI 3416

Size & Material Codes

F1 F3 F4 F5 F6 F7 F8
H1 H3 H4 H5 H6 H7 H8
J3 J4 J5 J6 J7 J8



Product Codes

QSI 3426

Size & Material Codes

F1 F3 F4 F5 F6 F7 F8
H1 H3 H4 H5 H6 H7 H8
J3 J4 J5 J6 J7 J8



Product Codes

QSI 3444

Size & Material Codes

F1 F3 F4 F5 F6 F7 F8
H3 H4 H5 H6 H7 H8
J3 J4 J5 J6 J7 J8



Product Codes

QSI 3920

Size & Material Codes

F1 F3 F4 F5 F6 F7 F8
H3 H4 H5 H6 H7 H8
J3 J4 J5 J6 J7 J8



Product Codes

QSI 3465

Size & Material Codes

F1 F3 F4 F5 F6 F7 F8
H1 H3 H4 H5 H6 H7 H8
J3 J4 J5 J6 J7 J8



Product Codes

QSI 3421

Size & Material Codes

F1 F3 F4 F5 F6 F7 F8
H1 H3 H4 H5 H6 H7 H8
J3 J4 J5 J6 J7 J8



Product Codes

QSI 3535

Size & Material Codes

F1 F3 F4 F5 F6 F7 F8
H3 H4 H5 H6 H7 H8
J3 J4 J5 J6 J7 J8



Product Codes

QSI 3532

Size & Material Codes

F1 F3 F4 F5 F6 F7 F8
H3 H4 H5 H6 H7 H8
J3 J4 J5 J6 J7 J8



Product Codes

QSI 3435

Size & Material Codes

E1 E3 E4 E5 E6 E7 E8
G1 G3 G4 G5 G6 G7 G8



Product Codes

QSI 3822

Size & Material Codes

F1 F3 F4 F5 F6 F7 F8
H3 H4 H5 H6 H7 H8
J3 J4 J5 J6 J7 J8



Product Codes

QSI 3777

Size & Material Codes

F1 F3 F4 F5 F6 F7 F8
H3 H4 H5 H6 H7 H8
J3 J4 J5 J6 J7 J8



Product Codes

QSI 3776

Size & Material Codes

F1 F3 F4 F5 F6 F7 F8
H3 H4 H5 H6 H7 H8
J3 J4 J5 J6 J7 J8



Product Codes

QSI 3915

Size & Material Codes

F1 F3 F4 F5 F6 F7 F8
H3 H4 H5 H6 H7 H8
J3 J4 J5 J6 J7 J8



Product Codes

QSI 38916

Size & Material Codes

F1 F3 F4 F5 F6 F7 F8
H3 H4 H5 H6 H7 H8
J3 J4 J5 J6 J7 J8



Product Codes

QSI 3550

Size & Material Codes

F1 F3 F4 F5 F6 F7 F8
H3 H4 H5 H6 H7 H8
J3 J4 J5 J6 J7 J8



Product Codes

QSI 3786

Size & Material Codes

F1 F3 F4 F5 F6 F7 F8
H3 H4 H5 H6 H7 H8
J3 J4 J5 J6 J7 J8



Product Codes

QSI 38917

Size & Material Codes

F1 F3 F4 F5 F6 F7 F8
H3 H4 H5 H6 H7 H8
J3 J4 J5 J6 J7 J8



Product Codes

QSI 3540

Size & Material Codes

F1 F3 F4 F5 F6 F7 F8
H3 H4 H5 H6 H7 H8
J3 J4 J5 J6 J7 J8

SIZE CODES

- A 120mm x 120mm D 250mm x 250mm G 450mm x 180mm J 600mm x 450mm
- B 180mm x 180mm E 340mm x 120mm H 450mm x 300mm (or 300 x 450)
- C 240mm x 240mm F 340mm x 240mm (or 240 x 340) I 200mm x 400mm

MATERIAL CODES

- 1 Screenprinted on PVC 4 Vinyl on PVC (No Screw Holes) 7 Vinyl on Coreflute
- 2 Screenprinted Blank c/w Vinyl Text on PVC 5 Vinyl on PVC (No Holes, c/w Dbl Sd Tape) 8 S/A Vinyl Sticker
- 3 Vinyl on PVC (With Screw holes) 6 Vinyl on Aluminium board 9 Vinyl on Magnetic



Product Codes

QSI 3534

Size & Material Codes

F1 F3 F4 F5 F6 F7 F8
H3 H4 H5 H6 H7 H8
J3 J4 J5 J6 J7 J8



Product Codes

QSI 3538

Size & Material Codes

F1 F3 F4 F5 F6 F7 F8
H3 H4 H5 H6 H7 H8
J3 J4 J5 J6 J7 J8



Product Codes

QSI 3549

Size & Material Codes

E1 E3 E4 E5 E6 E7 E8
G3 G4 G5 G6 G7 G8



Product Codes

QSI 3533

Size & Material Codes

F1 F3 F4 F5 F6 F7 F8
H3 H4 H5 H6 H7 H8
J3 J4 J5 J6 J7 J8



Product Codes

QSI 3543

Size & Material Codes

F1 F3 F4 F5 F6 F7 F8
H3 H4 H5 H6 H7 H8
J3 J4 J5 J6 J7 J8



Product Codes

QSI 3529

Size & Material Codes

F1 F3 F4 F5 F6 F7 F8
H3 H4 H5 H6 H7 H8
J3 J4 J5 J6 J7 J8



Product Codes

QSI 3531

Size & Material Codes

F1 F3 F4 F5 F6 F7 F8
H3 H4 H5 H6 H7 H8
J3 J4 J5 J6 J7 J8



Product Codes

QSI 3756

Size & Material Codes

F1 F3 F4 F5 F6 F7 F8
H3 H4 H5 H6 H7 H8
J3 J4 J5 J6 J7 J8



Product Codes

QSI 3521

Size & Material Codes

F1 F3 F4 F5 F6 F7 F8
H3 H4 H5 H6 H7 H8
J3 J4 J5 J6 J7 J8



Product Codes

QSI 3539

Size & Material Codes

F1 F3 F4 F5 F6 F7 F8
H3 H4 H5 H6 H7 H8
J3 J4 J5 J6 J7 J8



Product Codes

QSI 3821

Size & Material Codes

E1 E3 E4 E5 E6 E7 E8
G3 G4 G5 G6 G7 G8



Product Codes

QSI 3872

Size & Material Codes

F1 F3 F4 F5 F6 F7 F8
H3 H4 H5 H6 H7 H8
J3 J4 J5 J6 J7 J8



Product Codes

QSI 3547

Size & Material Codes

E1 E3 E4 E5 E6 E7 E8
G3 G4 G5 G6 G7 G8



Product Codes

QSI 3536

Size & Material Codes

F1 F3 F4 F5 F6 F7 F8
H3 H4 H5 H6 H7 H8
J3 J4 J5 J6 J7 J8



Product Codes

QSI 3868

Size & Material Codes

F1 F3 F4 F5 F6 F7 F8
H3 H4 H5 H6 H7 H8
J3 J4 J5 J6 J7 J8



Product Codes

QSI 3542

Size & Material Codes

F1 F3 F4 F5 F6 F7 F8
H3 H4 H5 H6 H7 H8
J3 J4 J5 J6 J7 J8



Product Codes

QSI 3530

Size & Material Codes

F1 F3 F4 F5 F6 F7 F8
H1 H3 H4 H5 H6 H7 H8
J3 J4 J5 J6 J7 J8



Product Codes

QSI 3523

Size & Material Codes

F1 F3 F4 F5 F6 F7 F8
H3 H4 H5 H6 H7 H8
J3 J4 J5 J6 J7 J8

SIZE CODES

- A 120mm x 120mm D 250mm x 250mm G 450mm x 180mm J 600mm x 450mm
- B 180mm x 180mm E 340mm x 120mm H 450mm x 300mm (or 300 x 450)
- C 240mm x 240mm F 340mm x 240mm (or 240 x 340) I 200mm x 400mm

MATERIAL CODES

- 1 Screenprinted on PVC 4 Vinyl on PVC (No Screw Holes) 7 Vinyl on Coreflute
- 2 Screenprinted Blank c/w Vinyl Text on PVC 5 Vinyl on PVC (No Holes, c/w Dbl Sd Tape) 8 S/A Vinyl Sticker
- 3 Vinyl on PVC (With Screw holes) 6 Vinyl on Aluminium board 9 Vinyl on Magnetic



Product Codes

QSI 3752

Size & Material Codes

F1 F3 F4 F5 F6 F7 F8
H3 H4 H5 H6 H7 H8
J3 J4 J5 J6 J7 J8



Product Codes

QSI 3429

Size & Material Codes

E1 E3 E4 E5 E6 E7 E8
G3 G4 G5 G6 G7 G8



Product Codes

QSI 3753

Size & Material Codes

F1 F3 F4 F5 F6 F7 F8
H3 H4 H5 H6 H7 H8
J3 J4 J5 J6 J7 J8



Product Codes

QSI 3541

Size & Material Codes

F1 F3 F4 F5 F6 F7 F8
H3 H4 H5 H6 H7 H8
J3 J4 J5 J6 J7 J8



Product Codes

QSI 3522

Size & Material Codes

F1 F3 F4 F5 F6 F7 F8
H3 H4 H5 H6 H7 H8
J3 J4 J5 J6 J7 J8



Product Codes

QSI 3548

Size & Material Codes

E1 E3 E4 E5 E6 E7 E8
G3 G4 G5 G6 G7 G8



Product Codes

QSI 3755

Size & Material Codes

F1 F3 F4 F5 F6 F7 F8
H3 H4 H5 H6 H7 H8
J3 J4 J5 J6 J7 J8



Product Codes

QSI 3537

Size & Material Codes

F1 F3 F4 F5 F6 F7 F8
H3 H4 H5 H6 H7 H8
J3 J4 J5 J6 J7 J8



Product Codes

QSI 3413

Size & Material Codes

F1 F3 F4 F5 F6 F7 F8
H3 H4 H5 H6 H7 H8
J3 J4 J5 J6 J7 J8



Product Codes

QSI 3966

Size & Material Codes

F1 F3 F4 F5 F6 F7 F8
H3 H4 H5 H6 H7 H8
J3 J4 J5 J6 J7 J8



Product Codes

QSI 3517

Size & Material Codes

F1 F3 F4 F5 F6 F7 F8
H1 H3 H4 H5 H6 H7 H8
J3 J4 J5 J6 J7 J8



Product Codes

QSI 3438

Size & Material Codes

F1 F3 F4 F5 F6 F7 F8
H1 H3 H4 H5 H6 H7 H8
J3 J4 J5 J6 J7 J8



Product Codes

QSI 3453

Size & Material Codes

F1 F3 F4 F5 F6 F7 F8
H1 H3 H4 H5 H6 H7 H8
J3 J4 J5 J6 J7 J8



Product Codes

QSI 3515

Size & Material Codes

F1 F3 F4 F5 F6 F7 F8
H3 H4 H5 H6 H7 H8
J3 J4 J5 J6 J7 J8



Product Codes

QSI 3505

Size & Material Codes

F1 F3 F4 F5 F6 F7 F8
H3 H4 H5 H6 H7 H8
J3 J4 J5 J6 J7 J8



Product Codes

QSI 3447

Size & Material Codes

F1 F3 F4 F5 F6 F7 F8
H3 H4 H5 H6 H7 H8
J3 J4 J5 J6 J7 J8



Product Codes

QSI 3493

Size & Material Codes

F1 F3 F4 F5 F6 F7 F8
H3 H4 H5 H6 H7 H8
J3 J4 J5 J6 J7 J8



Product Codes

QSI 3499

Size & Material Codes

F1 F3 F4 F5 F6 F7 F8
H3 H4 H5 H6 H7 H8
J3 J4 J5 J6 J7 J8



Product Codes

QSI 3504

Size & Material Codes

F1 F3 F4 F5 F6 F7 F8
H3 H4 H5 H6 H7 H8
J3 J4 J5 J6 J7 J8

SIZE CODES

- A 120mm x 120mm D 250mm x 250mm G 450mm x 180mm J 600mm x 450mm
- B 180mm x 180mm E 340mm x 120mm H 450mm x 300mm (or 300 x 450)
- C 240mm x 240mm F 340mm x 240mm (or 240 x 340) I 200mm x 400mm

MATERIAL CODES

- 1 Screenprinted on PVC
- 2 Screenprinted Blank c/w Vinyl Text on PVC
- 3 Vinyl on PVC (With Screw holes)
- 4 Vinyl on PVC (No Screw Holes)
- 5 Vinyl on PVC (No Holes, c/w Dbl Sd Tape)
- 6 Vinyl on Aluminium board
- 7 Vinyl on Coreflute
- 8 S/A Vinyl Sticker
- 9 Vinyl on Magnetic



Product Codes

QSI 3494

Size & Material Codes

F1 F3 F4 F5 F6 F7 F8
H3 H4 H5 H6 H7 H8
J3 J4 J5 J6 J7 J8



Product Codes

QSI 3498

Size & Material Codes

F1 F3 F4 F5 F6 F7 F8
H3 H4 H5 H6 H7 H8
J3 J4 J5 J6 J7 J8



Product Codes

QSI 3440

Size & Material Codes

F1 F3 F4 F5 F6 F7 F8
H3 H4 H5 H6 H7 H8
J3 J4 J5 J6 J7 J8



Product Codes

QSI 3501

Size & Material Codes

F1 F3 F4 F5 F6 F7 F8
H3 H4 H5 H6 H7 H8
J3 J4 J5 J6 J7 J8



Product Codes

QSI 3518

Size & Material Codes

F1 F3 F4 F5 F6 F7 F8
H3 H4 H5 H6 H7 H8
J3 J4 J5 J6 J7 J8



Product Codes

QSI 3514

Size & Material Codes

F1 F3 F4 F5 F6 F7 F8
H3 H4 H5 H6 H7 H8
J3 J4 J5 J6 J7 J8



Product Codes

QSI 3516

Size & Material Codes

F1 F3 F4 F5 F6 F7 F8
H3 H4 H5 H6 H7 H8
J3 J4 J5 J6 J7 J8



Product Codes

QSI 3496

Size & Material Codes

F1 F3 F4 F5 F6 F7 F8
H3 H4 H5 H6 H7 H8
J3 J4 J5 J6 J7 J8



Product Codes

QSI 3512

Size & Material Codes

F1 F3 F4 F5 F6 F7 F8
H3 H4 H5 H6 H7 H8
J3 J4 J5 J6 J7 J8



Product Codes

QSI 3506

Size & Material Codes

F1 F3 F4 F5 F6 F7 F8
H3 H4 H5 H6 H7 H8
J3 J4 J5 J6 J7 J8



Product Codes

QSI 3503

Size & Material Codes

F1 F3 F4 F5 F6 F7 F8
H3 H4 H5 H6 H7 H8
J3 J4 J5 J6 J7 J8



Product Codes

QSI 3495

Size & Material Codes

F1 F3 F4 F5 F6 F7 F8
H3 H4 H5 H6 H7 H8
J3 J4 J5 J6 J7 J8



Product Codes

QSI 3509

Size & Material Codes

F1 F3 F4 F5 F6 F7 F8
H3 H4 H5 H6 H7 H8
J3 J4 J5 J6 J7 J8



Product Codes

QSI 3508

Size & Material Codes

F1 F3 F4 F5 F6 F7 F8
H3 H4 H5 H6 H7 H8
J3 J4 J5 J6 J7 J8



Product Codes

QSI 3500

Size & Material Codes

F1 F3 F4 F5 F6 F7 F8
H3 H4 H5 H6 H7 H8
J3 J4 J5 J6 J7 J8



Product Codes

QSI 3497

Size & Material Codes

F1 F3 F4 F5 F6 F7 F8
H3 H4 H5 H6 H7 H8
J3 J4 J5 J6 J7 J8



Product Codes

QSI 3502

Size & Material Codes

F1 F3 F4 F5 F6 F7 F8
H3 H4 H5 H6 H7 H8
J3 J4 J5 J6 J7 J8

SIZE CODES

- A 120mm x 120mm D 250mm x 250mm G 450mm x 180mm J 600mm x 450mm
- B 180mm x 180mm E 340mm x 120mm H 450mm x 300mm (or 300 x 450)
- C 240mm x 240mm F 340mm x 240mm (or 240 x 340) I 200mm x 400mm

MATERIAL CODES

- 1 Screenprinted on PVC 4 Vinyl on PVC (No Screw Holes) 7 Vinyl on Coreflute
- 2 Screenprinted Blank c/w Vinyl Text on PVC 5 Vinyl on PVC (No Holes, c/w Dbl Sd Tape) 8 S/A Vinyl Sticker
- 3 Vinyl on PVC (With Screw holes) 6 Vinyl on Aluminium board 9 Vinyl on Magnetic



Product Codes

QSI 3507

Size & Material Codes

F1 F3 F4 F5 F6 F7 F8
H3 H4 H5 H6 H7 H8
J3 J4 J5 J6 J7 J8



Product Codes

QSI 3520

Size & Material Codes

F1 F3 F4 F5 F6 F7 F8
H3 H4 H5 H6 H7 H8
J3 J4 J5 J6 J7 J8



Product Codes

QSI 3511

Size & Material Codes

F1 F3 F4 F5 F6 F7 F8
H3 H4 H5 H6 H7 H8
J3 J4 J5 J6 J7 J8



Product Codes

QSI 3519

Size & Material Codes

F1 F3 F4 F5 F6 F7 F8
H3 H4 H5 H6 H7 H8
J3 J4 J5 J6 J7 J8



Product Codes

QSI 3510

Size & Material Codes

F1 F3 F4 F5 F6 F7 F8
H3 H4 H5 H6 H7 H8
J3 J4 J5 J6 J7 J8



Product Codes

QSI 3973

Size & Material Codes

F1 F3 F4 F5 F6 F7 F8
H3 H4 H5 H6 H7 H8
J3 J4 J5 J6 J7 J8



Product Codes

QSI 3439

Size & Material Codes

F2



Product Codes

QSI 3564

Size & Material Codes

F1 F3 F4 F5 F6 F7 F8
H3 H4 H5 H6 H7 H8



Product Codes

QSI 3597

Size & Material Codes

F1 F3 F4 F5 F6 F7 F8
H3 H4 H5 H6 H7 H8



Product Codes

QSI 3589

Size & Material Codes

F1 F3 F4 F5 F6 F7 F8
H3 H4 H5 H6 H7 H8



Product Codes

QSI 3596

Size & Material Codes

F1 F3 F4 F5 F6 F7 F8
H3 H4 H5 H6 H7 H8



Product Codes

QSI 3582

Size & Material Codes

F1 F3 F4 F5 F6 F7 F8
H3 H4 H5 H6 H7 H8



Product Codes

QSI 3570

Size & Material Codes

F1 F3 F4 F5 F6 F7 F8
H3 H4 H5 H6 H7 H8



Product Codes

QSI 3592

Size & Material Codes

F1 F3 F4 F5 F6 F7 F8
H3 H4 H5 H6 H7 H8



Product Codes

QSI 3575

Size & Material Codes

F1 F3 F4 F5 F6 F7 F8
H3 H4 H5 H6 H7 H8



Product Codes

QSI 3594

Size & Material Codes

F1 F3 F4 F5 F6 F7 F8
H3 H4 H5 H6 H7 H8



Product Codes

QSI 3565

Size & Material Codes

F1 F3 F4 F5 F6 F7 F8
H3 H4 H5 H6 H7 H8



Product Codes

QSI 3789

Size & Material Codes

E1 E3 E4 E5 E6 E7 E8
G3 G4 G5 G6 G7 G8



Product Codes

QSI 3581

Size & Material Codes

F1 F3 F4 F5 F6 F7 F8
H3 H4 H5 H6 H7 H8

SIZE CODES

- A 120mm x 120mm D 250mm x 250mm G 450mm x 180mm J 600mm x 450mm
- B 180mm x 180mm E 340mm x 120mm H 450mm x 300mm (or 300 x 450)
- C 240mm x 240mm F 340mm x 240mm (or 240 x 340) I 200mm x 400mm

MATERIAL CODES

- 1 Screenprinted on PVC 4 Vinyl on PVC (No Screw Holes) 7 Vinyl on Coreflute
- 2 Screenprinted Blank c/w Vinyl Text on PVC 5 Vinyl on PVC (No Holes, c/w Dbl Sd Tape) 8 S/A Vinyl Sticker
- 3 Vinyl on PVC (With Screw holes) 6 Vinyl on Aluminium board 9 Vinyl on Magnetic



Product Codes

QSI 3572

Size & Material Codes

F1 F3 F4 F5 F6 F7 F8
H3 H4 H5 H6 H7 H8



Product Codes

QSI 3567

Size & Material Codes

F1 F3 F4 F5 F6 F7 F8
H3 H4 H5 H6 H7 H8



Product Codes

QSI 3577

Size & Material Codes

F1 F3 F4 F5 F6 F7 F8
H3 H4 H5 H6 H7 H8



Product Codes

QSI 3580

Size & Material Codes

F1 F3 F4 F5 F6 F7 F8
H3 H4 H5 H6 H7 H8



Product Codes

QSI 3586

Size & Material Codes

F1 F3 F4 F5 F6 F7 F8
H3 H4 H5 H6 H7 H8



Product Codes

QSI 3576

Size & Material Codes

F1 F3 F4 F5 F6 F7 F8
H3 H4 H5 H6 H7 H8



Product Codes

QSI 3573

Size & Material Codes

F1 F3 F4 F5 F6 F7 F8
H3 H4 H5 H6 H7 H8



Product Codes

QSI 3568

Size & Material Codes

F1 F3 F4 F5 F6 F7 F8
H3 H4 H5 H6 H7 H8



Product Codes

QSI 3791

Size & Material Codes

E1 E3 E4 E5 E6 E7 E8
G3 G4 G5 G6 G7 G8



Product Codes

QSI 3566

Size & Material Codes

F1 F3 F4 F5 F6 F7 F8
H3 H4 H5 H6 H7 H8



Product Codes

QSI 3563

Size & Material Codes

F1 F3 F4 F5 F6 F7 F8
H3 H4 H5 H6 H7 H8



Product Codes

QSI 3595

Size & Material Codes

F1 F3 F4 F5 F6 F7 F8
H3 H4 H5 H6 H7 H8



Product Codes

QSI 3790

Size & Material Codes

E1 E3 E4 E5 E6 E7 E8
G3 G4 G5 G6 G7 G8



Product Codes

QSI 3593

Size & Material Codes

F1 F3 F4 F5 F6 F7 F8
H3 H4 H5 H6 H7 H8



Product Codes

QSI 3591

Size & Material Codes

F1 F3 F4 F5 F6 F7 F8
H3 H4 H5 H6 H7 H8



Product Codes

QSI 3588

Size & Material Codes

F1 F3 F4 F5 F6 F7 F8
H3 H4 H5 H6 H7 H8



Product Codes

QSI 3578

Size & Material Codes

F1 F3 F4 F5 F6 F7 F8
H3 H4 H5 H6 H7 H8



Product Codes

QSI 3579

Size & Material Codes

F1 F3 F4 F5 F6 F7 F8
H3 H4 H5 H6 H7 H8



Product Codes

QSI 3587

Size & Material Codes

F1 F3 F4 F5 F6 F7 F8
H3 H4 H5 H6 H7 H8



Product Codes

QSI 3583

Size & Material Codes

F1 F3 F4 F5 F6 F7 F8
H3 H4 H5 H6 H7 H8



Product Codes

QSI 3584

Size & Material Codes

F1 F3 F4 F5 F6 F7 F8
H3 H4 H5 H6 H7 H8



Product Codes

QSI 3590

Size & Material Codes

F1 F3 F4 F5 F6 F7 F8
H3 H4 H5 H6 H7 H8



Product Codes

QSI 3571

Size & Material Codes

F1 F3 F4 F5 F6 F7 F8
H3 H4 H5 H6 H7 H8



Product Codes

QSI 3600

Size & Material Codes

F2

SIZE CODES

- A 120mm x 120mm D 250mm x 250mm G 450mm x 180mm J 600mm x 450mm
- B 180mm x 180mm E 340mm x 120mm H 450mm x 300mm (or 300 x 450)
- C 240mm x 240mm F 340mm x 240mm (or 240 x 340) I 200mm x 400mm

MATERIAL CODES

- 1 Screenprinted on PVC 4 Vinyl on PVC (No Screw Holes) 7 Vinyl on Coreflute
- 2 Screenprinted Blank c/w Vinyl Text on PVC 5 Vinyl on PVC (No Holes, c/w Dbl Sd Tape) 8 S/A Vinyl Sticker
- 3 Vinyl on PVC (With Screw holes) 6 Vinyl on Aluminium board 9 Vinyl on Magnetic



Product Codes

QSI 3417

Size & Material Codes

F1 F3 F4 F5 F6 F7 F8
H1 H3 H4 H5 H6 H7 H8



Product Codes

QSI 3414

Size & Material Codes

F1 F3 F4 F5 F6 F7 F8
H1 H3 H4 H5 H6 H7 H8



Product Codes

QSI 3445

Size & Material Codes

F1 F3 F4 F5 F6 F7 F8
H3 H4 H5 H6 H7 H8



Product Codes

QSI 3418

Size & Material Codes

F1 F3 F4 F5 F6 F7 F8
H3 H4 H5 H6 H7 H8

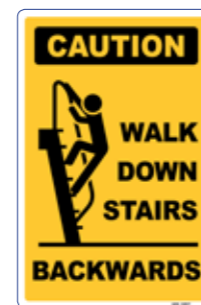

Product Codes

QSI 3857

Size & Material Codes

F1 F3 F4 F5 F6 F7 F8
H1 H3 H4 H5 H6 H7 H8



Product Codes

QSI 3784

Size & Material Codes

F1 F3 F4 F5 F6 F7 F8
H1 H3 H4 H5 H6 H7 H8



Product Codes

QSI 3716

Size & Material Codes

F1 F3 F4 F5 F6 F7 F8
H1 H3 H4 H5 H6 H7 H8



Product Codes

QSI 3717

Size & Material Codes

F1 F3 F4 F5 F6 F7 F8
H3 H4 H5 H6 H7 H8



Product Codes

QSI 3715

Size & Material Codes

F1 F3 F4 F5 F6 F7 F8
H3 H4 H5 H6 H7 H8



Product Codes

QSI 3720

Size & Material Codes

F1 F3 F4 F5 F6 F7 F8
H3 H4 H5 H6 H7 H8

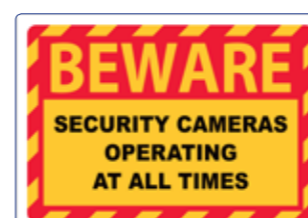

Product Codes

QSI 3694

Size & Material Codes

F1 F3 F4 F5 F6 F7 F8
H3 H4 H5 H6 H7 H8



Product Codes

QSI 3713

Size & Material Codes

F1 F3 F4 F5 F6 F7 F8
H3 H4 H5 H6 H7 H8

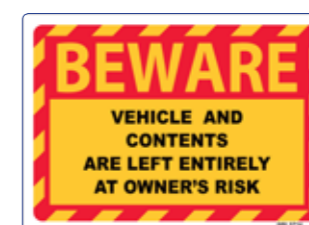

Product Codes

QSI 3714

Size & Material Codes

F1 F3 F4 F5 F6 F7 F8
H3 H4 H5 H6 H7 H8



Product Codes

QSI 3718

Size & Material Codes

F1 F3 F4 F5 F6 F7 F8
H3 H4 H5 H6 H7 H8



Product Codes

QSI 3712

Size & Material Codes

F1 F3 F4 F5 F6 F7 F8
H3 H4 H5 H6 H7 H8



Product Codes

QSI 3711

Size & Material Codes

F1 F3 F4 F5 F6 F7 F8
H3 H4 H5 H6 H7 H8

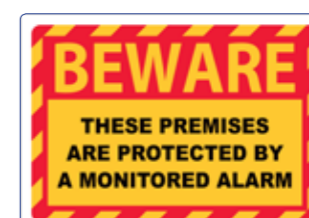

Product Codes

QSI 3847

Size & Material Codes

F1 F3 F4 F5 F6 F7 F8
H3 H4 H5 H6 H7 H8



Product Codes

QSI 3719

Size & Material Codes

F2
H2

SIZE CODES

- A 120mm x 120mm D 250mm x 250mm G 450mm x 180mm J 600mm x 450mm
- B 180mm x 180mm E 340mm x 120mm H 450mm x 300mm (or 300 x 450)
- C 240mm x 240mm F 340mm x 240mm (or 240 x 340) I 200mm x 400mm

MATERIAL CODES

- 1 Screenprinted on PVC 4 Vinyl on PVC (No Screw Holes) 7 Vinyl on Coreflute
- 2 Screenprinted Blank c/w Vinyl Text on PVC 5 Vinyl on PVC (No Holes, c/w Dbl Sd Tape) 8 S/A Vinyl Sticker
- 3 Vinyl on PVC (With Screw holes) 6 Vinyl on Aluminium board 9 Vinyl on Magnetic



Product Codes

QSI 3721

Size & Material Codes

F1 F3 F4 F5 F6 F7 F8
H3 H4 H5 H6 H7 H8



Product Codes

QSI 3772

Size & Material Codes

F1 F3 F4 F5 F6 F7 F8
H3 H4 H5 H6 H7 H8

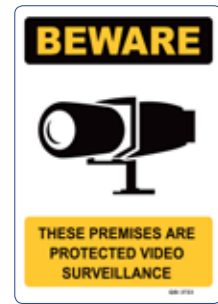

Product Codes

QSI 3723

Size & Material Codes

F1 F3 F4 F5 F6 F7 F8
H3 H4 H5 H6 H7 H8



Product Codes

QSI 3725

Size & Material Codes

F1 F3 F4 F5 F6 F7 F8
H3 H4 H5 H6 H7 H8

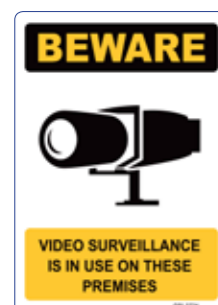

Product Codes

QSI 3724

Size & Material Codes

F1 F3 F4 F5 F6 F7 F8
H3 H4 H5 H6 H7 H8



Product Codes

QSI 3726

Size & Material Codes

F2



Product Codes

QSI 3809

Size & Material Codes

E1 E3 E4 E5 E6 E7 E8
G3 G4 G5 G6 G7 G8

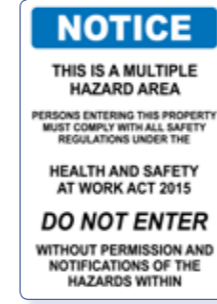

Product Codes

QSI 3441

Size & Material Codes

F1 F3 F4 F5 F6 F7 F8
H1 H3 H4 H5 H6 H7 H8



Product Codes

QSI 3770

Size & Material Codes

F1 F3 F4 F5 F6 F7 F8
H3 H4 H5 H6 H7 H8



Product Codes

QSI 3770R

Size & Material Codes

F1 F3 F4 F5 F6 F7 F8
H3 H4 H5 H6 H7 H8

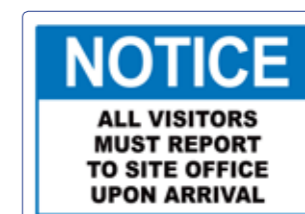

Product Codes

QSI 3666

Size & Material Codes

F1 F3 F4 F5 F6 F7 F8
H3 H4 H5 H6 H7 H8



Product Codes

QSI 3656

Size & Material Codes

F1 F3 F4 F5 F6 F7 F8
H3 H4 H5 H6 H7 H8



Product Codes

QSI 3651

Size & Material Codes

F1 F3 F4 F5 F6 F7 F8
H3 H4 H5 H6 H7 H8



Product Codes

QSI 3652

Size & Material Codes

F1 F3 F4 F5 F6 F7 F8
H3 H4 H5 H6 H7 H8



Product Codes

QSI 3653

Size & Material Codes

F1 F3 F4 F5 F6 F7 F8
H3 H4 H5 H6 H7 H8



Product Codes

QSI 3770NA

Size & Material Codes

F1 F3 F4 F5 F6 F7 F8
H3 H4 H5 H6 H7 H8

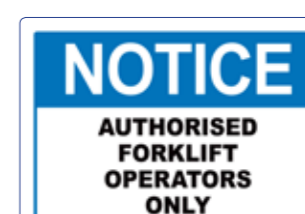

Product Codes

QSI 3663

Size & Material Codes

F1 F3 F4 F5 F6 F7 F8
H3 H4 H5 H6 H7 H8



Product Codes

QSI 3660

Size & Material Codes

F1 F3 F4 F5 F6 F7 F8
H3 H4 H5 H6 H7 H8



Product Codes

QSI 3658

Size & Material Codes

F2 F3 F4 F5 F6 F7 F8
H3 H4 H5 H6 H7 H8

SIZE CODES

- A 120mm x 120mm D 250mm x 250mm G 450mm x 180mm J 600mm x 450mm
- B 180mm x 180mm E 340mm x 120mm H 450mm x 300mm (or 300 x 450)
- C 240mm x 240mm F 340mm x 240mm (or 240 x 340) I 200mm x 400mm

MATERIAL CODES

- 1 Screenprinted on PVC
- 2 Screenprinted Blank c/w Vinyl Text on PVC
- 3 Vinyl on PVC (With Screw holes)
- 4 Vinyl on PVC (No Screw Holes)
- 5 Vinyl on PVC (No Holes, c/w Dbl Sd Tape)
- 6 Vinyl on Aluminium board
- 7 Vinyl on Coreflute
- 8 S/A Vinyl Sticker
- 9 Vinyl on Magnetic



Product Codes

QSI 3662

Size & Material Codes

F1 F3 F4 F5 F6 F7 F8
H3 H4 H5 H6 H7 H8



Product Codes

QSI 3664

Size & Material Codes

F1 F3 F4 F5 F6 F7 F8
H3 H4 H5 H6 H7 H8



Product Codes

QSI 3665

Size & Material Codes

F1 F3 F4 F5 F6 F7 F8
H3 H4 H5 H6 H7 H8



Product Codes

QSI 3643

Size & Material Codes

F1 F3 F4 F5 F6 F7 F8
H3 H4 H5 H6 H7 H8



Product Codes

QSI 3646

Size & Material Codes

F1 F3 F4 F5 F6 F7 F8
H3 H4 H5 H6 H7 H8



Product Codes

QSI 3645

Size & Material Codes

F1 F3 F4 F5 F6 F7 F8
H3 H4 H5 H6 H7 H8



Product Codes

QSI 3657

Size & Material Codes

F1 F3 F4 F5 F6 F7 F8
H3 H4 H5 H6 H7 H8



Product Codes

QSI 3644

Size & Material Codes

F1 F3 F4 F5 F6 F7 F8
H3 H4 H5 H6 H7 H8



Product Codes

QSI 3642

Size & Material Codes

F1 F3 F4 F5 F6 F7 F8
H3 H4 H5 H6 H7 H8



Product Codes

QSI 3659

Size & Material Codes

F1 F3 F4 F5 F6 F7 F8
H3 H4 H5 H6 H7 H8



Product Codes

QSI 3647

Size & Material Codes

F1 F3 F4 F5 F6 F7 F8
H3 H4 H5 H6 H7 H8



Product Codes

QSI 3648

Size & Material Codes

F1 F3 F4 F5 F6 F7 F8
H3 H4 H5 H6 H7 H8



Product Codes

QSI 3654

Size & Material Codes

F1 F3 F4 F5 F6 F7 F8
H3 H4 H5 H6 H7 H8



Product Codes

QSI 3641

Size & Material Codes

F1 F3 F4 F5 F6 F7 F8
H3 H4 H5 H6 H7 H8



Product Codes

QSI 3649

Size & Material Codes

F1 F3 F4 F5 F6 F7 F8
H3 H4 H5 H6 H7 H8



Product Codes

QSI 3808

Size & Material Codes

F2



Product Codes

QSI 3661

Size & Material Codes

F2 F3 F4 F5 F6 F7 F8
H3 H4 H5 H6 H7 H8



Product Codes

QSI 3806

Size & Material Codes

F1 F3 F4 F5 F6 F7 F8
H3 H4 H5 H6 H7 H8



Product Codes

QSI 3655

Size & Material Codes

F1 F3 F4 F5 F6 F7 F8
H3 H4 H5 H6 H7 H8



Product Codes

QSI 3650

Size & Material Codes

F1 F3 F4 F5 F6 F7 F8
H3 H4 H5 H6 H7 H8

SIZE CODES

- A 120mm x 120mm D 250mm x 250mm G 450mm x 180mm J 600mm x 450mm
- B 180mm x 180mm E 340mm x 120mm H 450mm x 300mm (or 300 x 450)
- C 240mm x 240mm F 340mm x 240mm (or 240 x 340) I 200mm x 400mm

MATERIAL CODES

- 1 Screenprinted on PVC
- 2 Screenprinted Blank c/w Vinyl Text on PVC
- 3 Vinyl on PVC (With Screw holes)
- 4 Vinyl on PVC (No Screw Holes)
- 5 Vinyl on PVC (No Holes, c/w Dbl Sd Tape)
- 6 Vinyl on Aluminium board
- 7 Vinyl on Coreflute
- 8 S/A Vinyl Sticker
- 9 Vinyl on Magnetic



Product Codes

QSI 3798

Size & Material Codes

F1 F3 F4 F5 F6 F7 F8
H3 H4 H5 H6 H7 H8



Product Codes

QSI 3732

Size & Material Codes

F1 F3 F4 F5 F6 F7 F8
H3 H4 H5 H6 H7 H8



Product Codes

QSI 3796

Size & Material Codes

F1 F3 F4 F5 F6 F7 F8
H3 H4 H5 H6 H7 H8



Product Codes

QSI 3799

Size & Material Codes

F1 F3 F4 F5 F6 F7 F8
H3 H4 H5 H6 H7 H8



Product Codes

QSI 3792

Size & Material Codes

F1 F3 F4 F5 F6 F7 F8
H3 H4 H5 H6 H7 H8



Product Codes

QSI 3730

Size & Material Codes

F1 F3 F4 F5 F6 F7 F8
H3 H4 H5 H6 H7 H8



Product Codes

QSI 3797

Size & Material Codes

F1 F3 F4 F5 F6 F7 F8
H3 H4 H5 H6 H7 H8



Product Codes

QSI 3731

Size & Material Codes

F1 F3 F4 F5 F6 F7 F8
H3 H4 H5 H6 H7 H8



Product Codes

QSI 3795

Size & Material Codes

F2 F3 F4 F5 F6 F7 F8
H3 H4 H5 H6 H7 H8



Product Codes

QSI 3793

Size & Material Codes

F1 F3 F4 F5 F6 F7 F8
H3 H4 H5 H6 H7 H8



Product Codes

QSI 3729

Size & Material Codes

F2 F3 F4 F5 F6 F7 F8
H3 H4 H5 H6 H7 H8



Product Codes

QSI 3794

Size & Material Codes

F1 F3 F4 F5 F6 F7 F8
H3 H4 H5 H6 H7 H8



Product Codes

QSI 3733

Size & Material Codes

F1 F3 F4 F5 F6 F7 F8
H3 H4 H5 H6 H7 H8



Product Codes

QSI 3735

Size & Material Codes

F2

SIZE CODES

- A 120mm x 120mm D 250mm x 250mm G 450mm x 180mm J 600mm x 450mm
- B 180mm x 180mm E 340mm x 120mm H 450mm x 300mm (or 300 x 450)
- C 240mm x 240mm F 340mm x 240mm (or 240 x 340) I 200mm x 400mm

MATERIAL CODES

- 1 Screenprinted on PVC
- 2 Screenprinted Blank c/w Vinyl Text on PVC
- 3 Vinyl on PVC (With Screw holes)
- 4 Vinyl on PVC (No Screw Holes)
- 5 Vinyl on PVC (No Holes, c/w Dbl Sd Tape)
- 6 Vinyl on Aluminium board
- 7 Vinyl on Coreflute
- 8 S/A Vinyl Sticker
- 9 Vinyl on Magnetic



Product Codes
QSI 3826

Size & Material Codes
F1 F3 F4 F5 F6 F7 F8
H3 H4 H5 H6 H7 H8



Product Codes
QSI 3829

Size & Material Codes
F1 F3 F4 F5 F6 F7 F8
H3 H4 H5 H6 H7 H8



Product Codes
QSI 3832

Size & Material Codes
F1 F3 F4 F5 F6 F7 F8
H3 H4 H5 H6 H7 H8



Product Codes
QSI 3831

Size & Material Codes
F1 F3 F4 F5 F6 F7 F8
H3 H4 H5 H6 H7 H8



Product Codes
QSI 3827

Size & Material Codes
F1 F3 F4 F5 F6 F7 F8
H3 H4 H5 H6 H7 H8



Product Codes
QSI 3830

Size & Material Codes
F1 F3 F4 F5 F6 F7 F8
H3 H4 H5 H6 H7 H8



Product Codes
QSI 3825

Size & Material Codes
F1 F3 F4 F5 F6 F7 F8
H3 H4 H5 H6 H7 H8



Product Codes
QSI 3834

Size & Material Codes
F1 F3 F4 F5 F6 F7 F8
H3 H4 H5 H6 H7 H8



Product Codes
QSI 3833

Size & Material Codes
F1 F3 F4 F5 F6 F7 F8
H3 H4 H5 H6 H7 H8



Product Codes
QSI 3828

Size & Material Codes
F2



Product Codes
QSI 3737

Size & Material Codes
F1 F3 F4 F5 F6 F7 F8
H3 H4 H5 H6 H7 H8



Product Codes
QSI 3743

Size & Material Codes
F1 F3 F4 F5 F6 F7 F8
H3 H4 H5 H6 H7 H8



Product Codes
QSI 3741

Size & Material Codes
F1 F3 F4 F5 F6 F7 F8
H3 H4 H5 H6 H7 H8



Product Codes
QSI 3736

Size & Material Codes
F1 F3 F4 F5 F6 F7 F8
H3 H4 H5 H6 H7 H8



Product Codes
QSI 3739

Size & Material Codes
F1 F3 F4 F5 F6 F7 F8
H3 H4 H5 H6 H7 H8



Product Codes
QSI 3740

Size & Material Codes
F1 F3 F4 F5 F6 F7 F8
H3 H4 H5 H6 H7 H8



Product Codes
QSI 3742

Size & Material Codes
F1 F3 F4 F5 F6 F7 F8
H3 H4 H5 H6 H7 H8



Product Codes
QSI 3738

Size & Material Codes
F1 F3 F4 F5 F6 F7 F8
H3 H4 H5 H6 H7 H8



Product Codes
QSI 3744

Size & Material Codes
F2

SIZE CODES

- A 120mm x 120mm D 250mm x 250mm G 450mm x 180mm J 600mm x 450mm
- B 180mm x 180mm E 340mm x 120mm H 450mm x 300mm (or 300 x 450)
- C 240mm x 240mm F 340mm x 240mm (or 240 x 340) I 200mm x 400mm

MATERIAL CODES

- 1 Screenprinted on PVC
- 2 Screenprinted Blank c/w Vinyl Text on PVC
- 3 Vinyl on PVC (With Screw holes)
- 4 Vinyl on PVC (No Screw Holes)
- 5 Vinyl on PVC (No Holes, c/w Dbl Sd Tape)
- 6 Vinyl on Aluminium board
- 7 Vinyl on Coreflute
- 8 S/A Vinyl Sticker
- 9 Vinyl on Magnetic



Product Codes

QSI 3425

Size & Material Codes

F1 F3 F4 F5 F6 F7 F8
H3 H4 H5 H6 H7 H8
J3 J4 J5 J6 J7 J8



Product Codes

QSI 3412

Size & Material Codes

F1 F3 F4 F5 F6 F7 F8
H3 H4 H5 H6 H7 H8
J3 J4 J5 J6 J7 J8



Product Codes

QSI 3892

Size & Material Codes

F1 F3 F4 F5 F6 F7 F8
H3 H4 H5 H6 H7 H8



Product Codes

QSI 3893

Size & Material Codes

F1 F3 F4 F5 F6 F7 F8
H3 H4 H5 H6 H7 H8



Product Codes

QSI 3693

Size & Material Codes

STOCK ITEM: 105X125MM
SELF-ADHESIVE
OTHER SIZES ON REQUEST



Product Codes

QSI 3560

Size & Material Codes

F1 F3 F4 F5 F6 F7 F8
H3 H4 H5 H6 H7 H8



Product Codes

QSI 3446

Size & Material Codes

F1 F3 F4 F5 F6 F7 F8
H3 H4 H5 H6 H7 H8



Product Codes

QSI 3894

Size & Material Codes

F1 F3 F4 F5 F6 F7 F8
H3 H4 H5 H6 H7 H8



Product Codes

QSI 3848

Size & Material Codes

F1
H1



Product Codes

QSI 3921

Size & Material Codes

F1 F3 F4 F5 F6 F7 F8
H3 H4 H5 H6 H7 H8



Product Codes

QSI 3524

Size & Material Codes

F1 F3 F4 F5 F6 F7 F8
H3 H4 H5 H6 H7 H8



Product Codes

QSI 3835

Size & Material Codes

H1



Product Codes

QSI 3890

Size & Material Codes

F1 F3 F4 F5 F6 F7 F8
H3 H4 H5 H6 H7 H8



Product Codes

QSI 3896

Size & Material Codes

F1 F3 F4 F5 F6 F7 F8
H3 H4 H5 H6 H7 H8



Product Codes

QSI 3903

Size & Material Codes

F2 F3 F4 F5 F6 F7 F8
H3 H4 H5 H6 H7 H8



Product Codes

QSI 3873

Size & Material Codes

F2 F3 F4 F5 F6 F7 F8
H3 H4 H5 H6 H7 H8

FLOOR/LEVEL NUMBER OF YOUR CHOICE ADDED



Product Codes

QSI 3895

Size & Material Codes

F1 F3 F4 F5 F6 F7 F8
H3 H4 H5 H6 H7 H8

SIZE CODES

- A 120mm x 120mm D 250mm x 250mm G 450mm x 180mm J 600mm x 450mm
- B 180mm x 180mm E 340mm x 120mm H 450mm x 300mm (or 300 x 450)
- C 240mm x 240mm F 340mm x 240mm (or 240 x 340) I 200mm x 400mm

MATERIAL CODES

- 1 Screenprinted on PVC 4 Vinyl on PVC (No Screw Holes) 7 Vinyl on Coreflute
- 2 Screenprinted Blank c/w Vinyl Text on PVC 5 Vinyl on PVC (No Holes, c/w Dbl Sd Tape) 8 S/A Vinyl Sticker
- 3 Vinyl on PVC (With Screw holes) 6 Vinyl on Aluminium board 9 Vinyl on Magnetic



Product Codes

QSI 3837

Size & Material Codes

H1



Product Codes

QSI 3412

Size & Material Codes

H1



Product Codes

QSI 3968SA

Size & Material Codes

STOCK ITEM: 170X115MM
SELF-ADHESIVE
OTHER SIZES ON REQUEST



Product Codes

QSI 3955

Size & Material Codes

I1 I3 I4 I5 I6 I7 I8



Product Codes

QSI 3956

Size & Material Codes

I1 I3 I4 I5 I6 I7 I8



Product Codes

QSI 3961

Size & Material Codes

I1 I3 I4 I5 I6 I7 I8



Product Codes

QSI 3960

Size & Material Codes

I1 I3 I4 I5 I6 I7 I8



Product Codes

QSI 3957

Size & Material Codes

I1 I3 I4 I5 I6 I7 I8



Product Codes

QSI 3958

Size & Material Codes

I1 I3 I4 I5 I6 I7 I8



Product Codes

QSI 3959

Size & Material Codes

I1 I3 I4 I5 I6 I7 I8

SIZE CODES

- A 120mm x 120mm D 250mm x 250mm G 450mm x 180mm J 600mm x 450mm
- B 180mm x 180mm E 340mm x 120mm H 450mm x 300mm (or 300 x 450)
- C 240mm x 240mm F 340mm x 240mm (or 240 x 340) I 200mm x 400mm

MATERIAL CODES

- 1 Screenprinted on PVC
- 2 Screenprinted Blank c/w Vinyl Text on PVC
- 3 Vinyl on PVC (With Screw holes)
- 4 Vinyl on PVC (No Screw Holes)
- 5 Vinyl on PVC (No Holes, c/w Dbl Sd Tape)
- 6 Vinyl on Aluminium board
- 7 Vinyl on Coreflute
- 8 S/A Vinyl Sticker
- 9 Vinyl on Magnetic



Product Codes

QSI 3526

Size & Material Codes

F1 F3 F4 F5 F6 F7 F8
H3 H4 H5 H6 H7 H8



Product Codes

QSI 3555

Size & Material Codes

F1 F3 F4 F5 F6 F7 F8
H3 H4 H5 H6 H7 H8



Product Codes

QSI 3553

Size & Material Codes

F1 F3 F4 F5 F6 F7 F8
H3 H4 H5 H6 H7 H8



Product Codes

QSI 3559

Size & Material Codes

F1 F3 F4 F5 F6 F7 F8
H3 H4 H5 H6 H7 H8



Product Codes

QSI 3870

Size & Material Codes

F1 F3 F4 F5 F6 F7 F8
H3 H4 H5 H6 H7 H8



Product Codes

QSI 3551

Size & Material Codes

F1 F3 F4 F5 F6 F7 F8
H3 H4 H5 H6 H7 H8



Product Codes

QSI 3557

Size & Material Codes

F1 F3 F4 F5 F6 F7 F8
H3 H4 H5 H6 H7 H8



Product Codes

QSI 3558

Size & Material Codes

F1 F3 F4 F5 F6 F7 F8
H3 H4 H5 H6 H7 H8



Product Codes

QSI 3552

Size & Material Codes

F1 F3 F4 F5 F6 F7 F8
H3 H4 H5 H6 H7 H8



Product Codes

QSI 3556

Size & Material Codes

F1 F3 F4 F5 F6 F7 F8
H3 H4 H5 H6 H7 H8



Product Codes

QSI 3561

Size & Material Codes

F1 F3 F4 F5 F6 F7 F8
H3 H4 H5 H6 H7 H8



Product Codes

QSI 3778

Size & Material Codes

F1 F3 F4 F5 F6 F7 F8
H3 H4 H5 H6 H7 H8



Product Codes

QSI 3691

Size & Material Codes

F1 F3 F4 F5 F6 F7 F8
H3 H4 H5 H6 H7 H8



Product Codes

QSI 3562

Size & Material Codes

F1 F3 F4 F5 F6 F7 F8
H3 H4 H5 H6 H7 H8



Product Codes

QSI 3781

Size & Material Codes

F1 F3 F4 F5 F6 F7 F8
H3 H4 H5 H6 H7 H8



Product Codes

QSI 3891

Size & Material Codes

F1 F3 F4 F5 F6 F7 F8
H3 H4 H5 H6 H7 H8



Product Codes

QSI 3554

Size & Material Codes

F1 F3 F4 F5 F6 F7 F8
H3 H4 H5 H6 H7 H8



Product Codes

QSI 3899

Size & Material Codes

F1 F3 F4 F5 F6 F7 F8
H3 H4 H5 H6 H7 H8

SIZE CODES

- A 120mm x 120mm D 250mm x 250mm G 450mm x 180mm J 600mm x 450mm
- B 180mm x 180mm E 340mm x 120mm H 450mm x 300mm (or 300 x 450)
- C 240mm x 240mm F 340mm x 240mm (or 240 x 340) I 200mm x 400mm

MATERIAL CODES

- 1 Screenprinted on PVC 4 Vinyl on PVC (No Screw Holes) 7 Vinyl on Coreflute
- 2 Screenprinted Blank c/w Vinyl Text on PVC 5 Vinyl on PVC (No Holes, c/w Dbl Sd Tape) 8 S/A Vinyl Sticker
- 3 Vinyl on PVC (With Screw holes) 6 Vinyl on Aluminium board 9 Vinyl on Magnetic



Product Codes

QSI 3525

Size & Material Codes

F1 F3 F4 F5 F6 F7 F8
H3 H4 H5 H6 H7 H8

LOOKING FOR THESE FIRE EXTINGUISHER SIGNS?



FIRE EXTINGUISHER IDENTIFICATION SIGNS ARE LISTED JUST BEFORE THIS SECTION



Product Codes

QSI 3458

Size & Material Codes

D1 D3 D4 D6 D8 D9



Product Codes

QSI 3459

Size & Material Codes

D1 D3 D4 D6 D8 D9



Product Codes

QSI 3802

Size & Material Codes

D1 D3 D4 D6 D8 D9



Product Codes

QSI 3849

Size & Material Codes

D1 D3 D4 D6 D8 D9



Product Codes

QSI 3845

Size & Material Codes

D1 D3 D4 D6 D8 D9



Product Codes

QSI 3932

Size & Material Codes

D1 D3 D4 D6 D8 D9



Product Codes

QSI 3454

Size & Material Codes

D1 D3 D4 D6 D8 D9



Product Codes

QSI 3455

Size & Material Codes

D1 D3 D4 D6 D8 D9



Product Codes

QSI 3456

Size & Material Codes

D1 D3 D4 D6 D8 D9



Product Codes

QSI 3457

Size & Material Codes

D1 D3 D4 D6 D8 D9



Product Codes

QSI 3843

Size & Material Codes

D1 D3 D4 D6 D8 D9



Product Codes

QSI 3676

Size & Material Codes

D1 D3 D4 D6 D8 D9

SIZE CODES

- A 120mm x 120mm D 250mm x 250mm G 450mm x 180mm J 600mm x 450mm
- B 180mm x 180mm E 340mm x 120mm H 450mm x 300mm (or 300 x 450)
- C 240mm x 240mm F 340mm x 240mm (or 240 x 340) I 200mm x 400mm

MATERIAL CODES

- 1 Screenprinted on PVC 4 Vinyl on PVC (No Screw Holes) 7 Vinyl on Coreflute
- 2 Screenprinted Blank c/w Vinyl Text on PVC 5 Vinyl on PVC (No Holes, c/w Dbl Sd Tape) 8 S/A Vinyl Sticker
- 3 Vinyl on PVC (With Screw holes) 6 Vinyl on Aluminium board 9 Vinyl on Magnetic



Product Codes

QSI 3754

Size & Material Codes

D1 D3 D4 D6 D8 D9



Product Codes

QSI 3461

Size & Material Codes

D1 D3 D4 D6 D8 D9



Product Codes

QSI 3964

Size & Material Codes

D1 D3 D4 D6 D8 D9



Product Codes

QSI 3765

Size & Material Codes

D1 D3 D4 D6 D8 D9



Product Codes

QSI 3841

Size & Material Codes

D1 D3 D4 D6 D8 D9



Product Codes

QSI 3952

Size & Material Codes

D1 D3 D4 D6 D8 D9



Product Codes

QSI 3846

Size & Material Codes

D1 D3 D4 D6 D8 D9



Product Codes

QSI 3801

Size & Material Codes

D1 D3 D4 D6 D8 D9



Product Codes

QSI 3838

Size & Material Codes

D1 D3 D4 D6 D8 D9



Product Codes

QSI 3460

Size & Material Codes

D1 D3 D4 D6 D8 D9

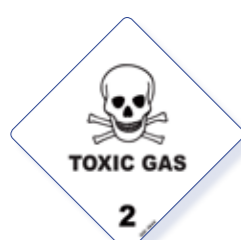

Product Codes

QSI 3844

Size & Material Codes

D1 D3 D4 D6 D8 D9



Product Codes

QSI 3400

Size & Material Codes

F1 F3 F4 F5 F6 F7 F8
H3 H4 H5 H6 H7 H8



Product Codes

QSI 3528

Size & Material Codes

G1 G3 G4 G5 G6 G7 G8

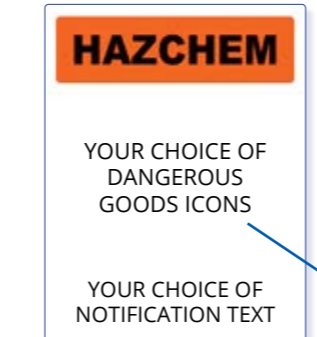

Product Codes

QSI 3411

Size & Material Codes

CUSTOMISABLE LARGE
HAZCHEM SIGN
450 X 600MM AS STANDARD
(OTHER SIZES ON REQUEST)



Product Codes

QSI 3840_C

Size & Material Codes

F1 F3 F4 F5 F6 F7 F8
H3 H4 H5 H6 H7 H8



Product Codes

QSI 3840_G

Size & Material Codes

F1 F3 F4 F5 F6 F7 F8
H3 H4 H5 H6 H7 H8



Product Codes

QSI 3840_O

Size & Material Codes

F1 F3 F4 F5 F6 F7 F8
H3 H4 H5 H6 H7 H8

SIZE CODES

- A 120mm x 120mm D 250mm x 250mm G 450mm x 180mm J 600mm x 450mm
- B 180mm x 180mm E 340mm x 120mm H 450mm x 300mm (or 300 x 450)
- C 240mm x 240mm F 340mm x 240mm (or 240 x 340) I 200mm x 400mm

MATERIAL CODES

- 1 Screenprinted on PVC 4 Vinyl on PVC (No Screw Holes) 7 Vinyl on Coreflute
- 2 Screenprinted Blank c/w Vinyl Text on PVC 5 Vinyl on PVC (No Holes, c/w Dbl Sd Tape) 8 S/A Vinyl Sticker
- 3 Vinyl on PVC (With Screw holes) 6 Vinyl on Aluminium board 9 Vinyl on Magnetic



Product Codes

QSI 3854

Size & Material Codes

E1 E3 E4 E5 E6 E7 E8
G3 G4 G5 G6 G7 G8



Product Codes

QSI 3875

Size & Material Codes

F1 F3 F4 F5 F6 F7 F8
H3 H4 H5 H6 H7 H8
J3 J4 J5 J6 J7 J8

DOUBLE SIDED



Product Codes

QSI 3824

Size & Material Codes

E1 E3 E4 E6 E7
G3 G4 G6 G7



Product Codes

QSI 3419

Size & Material Codes

E1 E3 E4 E5 E6 E7 E8
G3 G4 G5 G6 G7 G8



Product Codes

QSI 3450

Size & Material Codes

E1 E3 E4 E5 E6 E7 E8
G3 G4 G5 G6 G7 G8



Product Codes

QSI 3449

Size & Material Codes

E1 E3 E4 E5 E6 E7 E8
G3 G4 G5 G6 G7 G8



Product Codes

QSI 3884

Size & Material Codes

E1 E3 E4 E5 E6 E7 E8
G3 G4 G5 G6 G7 G8



Product Codes

QSI 3874

Size & Material Codes

F1 F3 F4 F5 F6 F7 F8
H3 H4 H5 H6 H7 H8
J3 J4 J5 J6 J7 J8



Product Codes

QSI 3880

Size & Material Codes

F1 F3 F4 F5 F6 F7 F8
H3 H4 H5 H6 H7 H8
J3 J4 J5 J6 J7 J8



Product Codes

QSI 3886

Size & Material Codes

E1 E3 E4 E5 E6 E7 E8
G3 G4 G5 G6 G7 G8



Product Codes

QSI 3448

Size & Material Codes

E1 E3 E4 E5 E6 E7 E8
G3 G4 G5 G6 G7 G8



Product Codes

QSI 3888

Size & Material Codes

E1 E3 E4 E5 E6 E7 E8
G3 G4 G5 G6 G7 G8



Product Codes

QSI 3877

Size & Material Codes

F1 F3 F4 F5 F6 F7 F8
H3 H4 H5 H6 H7 H8
J3 J4 J5 J6 J7 J8



Product Codes

QSI 3878

Size & Material Codes

F1 F3 F4 F5 F6 F7 F8
H3 H4 H5 H6 H7 H8
J3 J4 J5 J6 J7 J8



Product Codes

QSI 3879

Size & Material Codes

F1 F3 F4 F5 F6 F7 F8
H3 H4 H5 H6 H7 H8
J3 J4 J5 J6 J7 J8



Product Codes

QSI 3881

Size & Material Codes

F1 F3 F4 F5 F6 F7 F8
H3 H4 H5 H6 H7 H8
J3 J4 J5 J6 J7 J8



Product Codes

QSI 3420

Size & Material Codes

E1 E3 E4 E5 E6 E7 E8
G3 G4 G5 G6 G7 G8



Product Codes

QSI 3889

Size & Material Codes

E1 E3 E4 E5 E6 E7 E8
G3 G4 G5 G6 G7 G8



Product Codes

QSI 3885

Size & Material Codes

E1 E3 E4 E5 E6 E7 E8
G3 G4 G5 G6 G7 G8



Product Codes

QSI 3883

Size & Material Codes

E1 E3 E4 E5 E6 E7 E8
G3 G4 G5 G6 G7 G8



Product Codes

QSI 3882

Size & Material Codes

E1 E3 E4 E5 E6 E7 E8
G3 G4 G5 G6 G7 G8



Product Codes

QSI 3876

Size & Material Codes

F1 F3 F4 F5 F6 F7 F8
H3 H4 H5 H6 H7 H8
J3 J4 J5 J6 J7 J8



Product Codes

QSI 3451

Size & Material Codes

E1 E3 E4 E5 E6 E7 E8
G3 G4 G5 G6 G7 G8



Product Codes

QSI 3887

Size & Material Codes

E1 E3 E4 E5 E6 E7 E8
G3 G4 G5 G6 G7 G8

SIZE CODES

- A 120mm x 120mm D 250mm x 250mm G 450mm x 180mm J 600mm x 450mm
- B 180mm x 180mm E 340mm x 120mm H 450mm x 300mm (or 300 x 450)
- C 240mm x 240mm F 340mm x 240mm (or 240 x 340) I 200mm x 400mm

MATERIAL CODES

- 1 Screenprinted on PVC
- 2 Screenprinted Blank c/w Vinyl Text on PVC
- 3 Vinyl on PVC (With Screw holes)
- 4 Vinyl on PVC (No Screw Holes)
- 5 Vinyl on PVC (No Holes, c/w Dbl Sd Tape)
- 6 Vinyl on Aluminium board
- 7 Vinyl on Coreflute
- 8 S/A Vinyl Sticker
- 9 Vinyl on Magnetic



Product Codes

QSI 3424

Size & Material Codes

E1 E3 E4 E5 E6 E7 E8
G3 G4 G5 G6 G7 G8



Product Codes

QSI 3432

Size & Material Codes

A1 A3 A4 A5 A8
B3 B4 B5 B8
C3 C4 C5 C8
D3 D4 D5 D6 D8



Product Codes

QSI 3855

Size & Material Codes

F1 F3 F4 F5 F6 F7 F8
H3 H4 H5 H6 H7 H8



Product Codes

QSI 3853

Size & Material Codes

F1 F3 F4 F5 F6 F7 F8
H3 H4 H5 H6 H7 H8



Product Codes

QSI 3433

Size & Material Codes

A1 A3 A4 A5 A8
B3 B4 B5 B8
C3 C4 C5 C8
D3 D4 D5 D6 D8



Product Codes

QSI 3709

Size & Material Codes

A1 A3 A4 A5 A8
B3 B4 B5 B8
C3 C4 C5 C8
D3 D4 D5 D6 D8



Product Codes

QSI 3856

Size & Material Codes

F1 F3 F4 F5 F6 F7 F8
H3 H4 H5 H6 H7 H8



Product Codes

QSI 3865

Size & Material Codes

F1 F3 F4 F5 F6 F7 F8
H3 H4 H5 H6 H7 H8



Product Codes

QSI 3708

Size & Material Codes

A1 A3 A4 A5 A8
B3 B4 B5 B8
C3 C4 C5 C8
D3 D4 D5 D6 D8



Product Codes

QSI 3710

Size & Material Codes

A1 A3 A4 A5 A8
B3 B4 B5 B8
C3 C4 C5 C8
D3 D4 D5 D6 D8



Product Codes

QSI 3864

Size & Material Codes

F1 F3 F4 F5 F6 F7 F8
H3 H4 H5 H6 H7 H8



Product Codes

QSI 3862

Size & Material Codes

F1 F3 F4 F5 F6 F7 F8
H3 H4 H5 H6 H7 H8



Product Codes

QSI 3686

Size & Material Codes

F1 F3 F4 F5 F6 F7 F8
H3 H4 H5 H6 H7 H8



Product Codes

QSI 3687

Size & Material Codes

F1 F3 F4 F5 F6 F7 F8
H3 H4 H5 H6 H7 H8



Product Codes

QSI 3685

Size & Material Codes

F1 F3 F4 F5 F6 F7 F8
H3 H4 H5 H6 H7 H8



Product Codes

QSI 3689

Size & Material Codes

E1 E3 E4 E5 E6 E7 E8
G3 G4 G5 G6 G7 G8



Product Codes

QSI 3688

Size & Material Codes

F1 F3 F4 F5 F6 F7 F8
H3 H4 H5 H6 H7 H8



Product Codes

QSI 3690

Size & Material Codes

F1 F3 F4 F5 F6 F7 F8
H3 H4 H5 H6 H7 H8

SIZE CODES

- A 120mm x 120mm D 250mm x 250mm G 450mm x 180mm J 600mm x 450mm
- B 180mm x 180mm E 340mm x 120mm H 450mm x 300mm (or 300 x 450)
- C 240mm x 240mm F 340mm x 240mm (or 240 x 340) I 200mm x 400mm

MATERIAL CODES

- 1 Screenprinted on PVC
- 2 Screenprinted Blank c/w Vinyl Text on PVC
- 3 Vinyl on PVC (With Screw holes)
- 4 Vinyl on PVC (No Screw Holes)
- 5 Vinyl on PVC (No Holes, c/w Dbl Sd Tape)
- 6 Vinyl on Aluminium board
- 7 Vinyl on Coreflute
- 8 S/A Vinyl Sticker
- 9 Vinyl on Magnetic



Product Codes

QSI 3672

Size & Material Codes

A1 A3 A4 A5 A8
B3 B4 B5 B8
C3 C4 C5 C8
D3 D4 D5 D6 D8



Product Codes

QSI 3678

Size & Material Codes

A1 A3 A4 A5 A8
B3 B4 B5 B8
C3 C4 C5 C8
D3 D4 D5 D6 D8



Product Codes

QSI 3682

Size & Material Codes

A1 A3 A4 A5 A8
B3 B4 B5 B8
C3 C4 C5 C8
D3 D4 D5 D6 D8



Product Codes

QSI 3695

Size & Material Codes

A1 A3 A4 A5 A8
B3 B4 B5 B8
C3 C4 C5 C8
D3 D4 D5 D6 D8



Product Codes

QSI 3668

Size & Material Codes

A1 A3 A4 A5 A8
B3 B4 B5 B8
C3 C4 C5 C8
D3 D4 D5 D6 D8



Product Codes

QSI 3673

Size & Material Codes

A1 A3 A4 A5 A8
B3 B4 B5 B8
C3 C4 C5 C8
D3 D4 D5 D6 D8



Product Codes

QSI 3696

Size & Material Codes

A1 A3 A4 A5 A8
B3 B4 B5 B8
C3 C4 C5 C8
D3 D4 D5 D6 D8



Product Codes

QSI 3698

Size & Material Codes

A1 A3 A4 A5 A8
B3 B4 B5 B8
C3 C4 C5 C8
D3 D4 D5 D6 D8



Product Codes

QSI 3679

Size & Material Codes

A1 A3 A4 A5 A8
B3 B4 B5 B8
C3 C4 C5 C8
D3 D4 D5 D6 D8



Product Codes

QSI 3669

Size & Material Codes

A1 A3 A4 A5 A8
B3 B4 B5 B8
C3 C4 C5 C8
D3 D4 D5 D6 D8



Product Codes

QSI 3681

Size & Material Codes

A1 A3 A4 A5 A8
B3 B4 B5 B8
C3 C4 C5 C8
D3 D4 D5 D6 D8



Product Codes

QSI 3684

Size & Material Codes

A1 A3 A4 A5 A8
B3 B4 B5 B8
C3 C4 C5 C8
D3 D4 D5 D6 D8



Product Codes

QSI 3671

Size & Material Codes

A1 A3 A4 A5 A8
B3 B4 B5 B8
C3 C4 C5 C8
D3 D4 D5 D6 D8



Product Codes

QSI 3667

Size & Material Codes

A1 A3 A4 A5 A8
B3 B4 B5 B8
C3 C4 C5 C8
D3 D4 D5 D6 D8



Product Codes

QSI 3675

Size & Material Codes

A1 A3 A4 A5 A8
B3 B4 B5 B8
C3 C4 C5 C8
D3 D4 D5 D6 D8



Product Codes

QSI 3858

Size & Material Codes

A1 A3 A4 A5 A8
B3 B4 B5 B8
C3 C4 C5 C8
D3 D4 D5 D6 D8



Product Codes

QSI 3697

Size & Material Codes

A1 A3 A4 A5 A8
B3 B4 B5 B8
C3 C4 C5 C8
D3 D4 D5 D6 D8



Product Codes

QSI 3683

Size & Material Codes

A1 A3 A4 A5 A8
B3 B4 B5 B8
C3 C4 C5 C8
D3 D4 D5 D6 D8



Product Codes

QSI 3680

Size & Material Codes

A1 A3 A4 A5 A8
B3 B4 B5 B8
C3 C4 C5 C8
D3 D4 D5 D6 D8



Product Codes

QSI 3677

Size & Material Codes

A1 A3 A4 A5 A8
B3 B4 B5 B8
C3 C4 C5 C8
D3 D4 D5 D6 D8



Product Codes

QSI 3771

Size & Material Codes

A1 A3 A4 A5 A8
B3 B4 B5 B8
C3 C4 C5 C8
D3 D4 D5 D6 D8



Product Codes

QSI 3769

Size & Material Codes

A1 A3 A4 A5 A8
B3 B4 B5 B8
C3 C4 C5 C8
D3 D4 D5 D6 D8



Product Codes

QSI 3674

Size & Material Codes

A1 A3 A4 A5 A8
B3 B4 B5 B8
C3 C4 C5 C8
D3 D4 D5 D6 D8



Product Codes

QSI 3759

Size & Material Codes

F1 F3 F4 F5 F6 F7 F8
H3 H4 H5 H6 H7 H8



Product Codes

QSI 3758

Size & Material Codes

F1 F3 F4 F5 F6 F7 F8
H3 H4 H5 H6 H7 H8



Product Codes

QSI 3757

Size & Material Codes

F1 F3 F4 F5 F6 F7 F8
H3 H4 H5 H6 H7 H8



Product Codes

QSI 3760

Size & Material Codes

F1 F3 F4 F5 F6 F7 F8
H3 H4 H5 H6 H7 H8



Product Codes

QSI 3443

Size & Material Codes

F1 F3 F4 F5 F6 F7 F8
H3 H4 H5 H6 H7 H8



Product Codes

QSI 3442

Size & Material Codes

F1 F3 F4 F5 F6 F7 F8
H3 H4 H5 H6 H7 H8



Product Codes

QSI 3767

Size & Material Codes

F1 F3 F4 F5 F6 F7 F8
H3 H4 H5 H6 H7 H8



Product Codes

QSI 3761

Size & Material Codes

F1 F3 F4 F5 F6 F7 F8
H3 H4 H5 H6 H7 H8



Product Codes

QSI 3768

Size & Material Codes

F1 F3 F4 F5 F6 F7 F8
H3 H4 H5 H6 H7 H8



Product Codes

QSI 3762

Size & Material Codes

F1 F3 F4 F5 F6 F7 F8
H3 H4 H5 H6 H7 H8



Product Codes

QSI 3766

Size & Material Codes

F1 F3 F4 F5 F6 F7 F8
H3 H4 H5 H6 H7 H8



Product Codes

QSI 3763

Size & Material Codes

F1 F3 F4 F5 F6 F7 F8
H3 H4 H5 H6 H7 H8



Product Codes

QSI 3764

Size & Material Codes

F1 F3 F4 F5 F6 F7 F8
H3 H4 H5 H6 H7 H8



Product Codes

QSI 3810

Size & Material Codes

F3 F4 F5 F6 F7 F8
H3 H4 H5 H6 H7 H8



Product Codes

QSI 3811

Size & Material Codes

F3 F4 F5 F6 F7 F8
H3 H4 H5 H6 H7 H8



Product Codes

QSI 3814

Size & Material Codes

F1 F3 F4 F5 F6 F7 F8
H3 H4 H5 H6 H7 H8



Product Codes

QSI 3815

Size & Material Codes

F1 F3 F4 F5 F6 F7 F8
H3 H4 H5 H6 H7 H8



Product Codes

QSI 3813

Size & Material Codes

F1 F3 F4 F5 F6 F7 F8
H3 H4 H5 H6 H7 H8



Product Codes

QSI 3812

Size & Material Codes

F1 F3 F4 F5 F6 F7 F8
H3 H4 H5 H6 H7 H8



Product Codes

QSI 3816

Size & Material Codes

F1 F3 F4 F5 F6 F7 F8
H3 H4 H5 H6 H7 H8

SIZE CODES

- A 120mm x 120mm D 250mm x 250mm G 450mm x 180mm J 600mm x 450mm
- B 180mm x 180mm E 340mm x 120mm H 450mm x 300mm (or 300 x 450)
- C 240mm x 240mm F 340mm x 240mm (or 240 x 340) I 200mm x 400mm

MATERIAL CODES

- 1 Screenprinted on PVC
- 2 Screenprinted Blank c/w Vinyl Text on PVC
- 3 Vinyl on PVC (With Screw holes)
- 4 Vinyl on PVC (No Screw Holes)
- 5 Vinyl on PVC (No Holes, c/w Dbl Sd Tape)
- 6 Vinyl on Aluminium board
- 7 Vinyl on Coreflute
- 8 S/A Vinyl Sticker
- 9 Vinyl on Magnetic



Product Codes

QSI 3817

Size & Material Codes

F1 F3 F4 F5 F6 F7 F8
H3 H4 H5 H6 H7 H8



Product Codes

QSI 3818

Size & Material Codes

F1 F3 F4 F5 F6 F7 F8
H3 H4 H5 H6 H7 H8



Product Codes

QSI 3820

Size & Material Codes

F1 F3 F4 F5 F6 F7 F8
H3 H4 H5 H6 H7 H8



Product Codes

QSI 3819

Size & Material Codes

F1 F3 F4 F5 F6 F7 F8
H3 H4 H5 H6 H7 H8



Product Codes

QSI 3427

Size & Material Codes

E1 E3 E4 E5 E6 E7 E8
G3 G4 G5 G6 G7 G8



Product Codes

QSI 3423

Size & Material Codes

F1 F3 F4 F5 F6 F7 F8
H3 H4 H5 H6 H7 H8



Product Codes

QSI 3422

Size & Material Codes

E1 E3 E4 E5 E6 E7 E8
G3 G4 G5 G6 G7 G8



Product Codes

QSI 3430

Size & Material Codes

STOCK ITEM: 450X120MM
SCREENPRINTED PVC OR
SELF ADHESIVE ONLY



Product Codes

QSI 3431

Size & Material Codes

STOCK ITEM: 450X120MM
SCREENPRINTED PVC OR
SELF ADHESIVE ONLY



Product Codes

QSI 3745

Size & Material Codes

F1 F3 F4 F5 F6 F7 F8
H3 H4 H5 H6 H7 H8



Product Codes

QSI 3401

Size & Material Codes

A3 A4 A5 A8
B3 B4 B5 B8
D1 D3 D4 D5 D6 D8

SIZE CODES

- A 120mm x 120mm D 250mm x 250mm G 450mm x 180mm J 600mm x 450mm
- B 180mm x 180mm E 340mm x 120mm H 450mm x 300mm (or 300 x 450)
- C 240mm x 240mm F 340mm x 240mm (or 240 x 340) I 200mm x 400mm

MATERIAL CODES

- 1 Screenprinted on PVC
- 2 Screenprinted Blank c/w Vinyl Text on PVC
- 3 Vinyl on PVC (With Screw holes)
- 4 Vinyl on PVC (No Screw Holes)
- 5 Vinyl on PVC (No Holes, c/w Dbl Sd Tape)
- 6 Vinyl on Aluminium board
- 7 Vinyl on Coreflute
- 8 S/A Vinyl Sticker
- 9 Vinyl on Magnetic

Branding

Our printing capabilities go way beyond just making signs. We also add custom branding to just about whatever you need.



Standard armbands available in a range of colours, with your choice of heatset text:

- Hi Vis Orange / black text
- Green / white text
- Yellow / black text
- Red / white text
- Blue / white text

When ordering, simply state the armband colour and the text required, we'll do the rest. Other options, e.g. reflective silver text, are available if required.

Branding can also be applied to other items - wet weather clothing, hard hats, first aid kits, polo shirts, tee shirts, height safety harnesses, magnetic vehicle signage, adhesive labels and more besides. Whatever you need branding, we can probably help!



What is best for your branding needs?

Tried and trusted, heatsetting is a widely used method for applying branding and text to a variety of materials, particularly fabrics. Although the technique has been around for decades, the latest advances offer some real benefits when compared to the old standard products.

We offer a choice of heatset materials, including the latest sublimation printing technology to cover all circumstances and bring you solutions that fit your requirements.

COLOURED HEATSET VINYL:

Solid, single-colour heatset vinyl.

Pros: Because the material is a solid colour, it is fully opaque and lasts extremely well. Colour cannot be removed from the vinyl surface by abrasion or chemicals.

Cons: Limited ability to handle high detail, can take lots of time to weed out complex designs.



PRINTABLE WHITE HEATSET:

Digitally printed white heatset vinyl.

Pros: Well suited to designs featuring gradients and high detail artwork.

Cons: Can take lots of time to weed out complex designs, often needs to incorporate a white outline/border. Some printed colours may be affected by Hi Vis clothing.

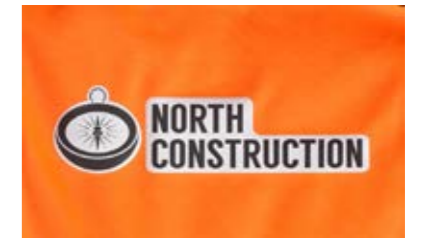

PRINTABLE CLEAR HEATSET:

Digitally printed clear heatset vinyl.

Pros: Well suited to designs featuring gradients and high detail artwork.

Cons: Generally needs to incorporate a clear outline/border. Reduced opacity, particularly on Hi Vis - blacks are OK but colours are often affected by garment colour.



SUBLIMATION PRINTED HEATSET:

Digitally printed ink-based transfer.

Pros: Handles high detail designs well, gives a 'dyed-in' finish rather than a surface-applied look. No weeding time.

Cons: Only suitable for polyester or high synthetic content fabrics, generally limited to black-only designs. High heatset temperature.



Speak to our sales team about your garment branding requirements, to get the right products for you every time.

First Aid Kits | Height Safety | General Safety
Medical Products | Paramedic/Rescue | Survival Equipment
Traffic Management | Industrial Clothing | Safety Signs